

(NPN) MPS8098, MPS8099*, (PNP) MPS8598, MPS8599*

*Preferred Devices

Amplifier Transistors

Voltage and Current are Negative
for PNP Transistors

Features

- Pb-Free Packages are Available*

MAXIMUM RATINGS

Rating	Symbol	Value	Unit
Collector-Emitter Voltage MPS8098, MPS8598 MPS8099, MPS8599	V_{CEO}	60 80	Vdc
Collector-Base Voltage MPS8098, MPS8598 MPS8099, MPS8599	V_{CBO}	60 80	Vdc
Emitter-Base Voltage	V_{EBO}	4.0	Vdc
Collector Current - Continuous	I_C	500	mAdc
Total Device Dissipation @ $T_A = 25^\circ\text{C}$ Derate above 25°C	P_D	625 5.0	mW mW/ $^\circ\text{C}$
Total Device Dissipation @ $T_C = 25^\circ\text{C}$ Derate above 25°C	P_D	1.5 12	W mW/ $^\circ\text{C}$
Operating and Storage Junction Temperature Range	T_J, T_{stg}	-55 to +150	$^\circ\text{C}$

THERMAL CHARACTERISTICS

Characteristic	Symbol	Max	Unit
Thermal Resistance, Junction-to-Ambient (Note 1)	$R_{\theta JA}$	200	$^\circ\text{C}/\text{W}$
Thermal Resistance, Junction-to-Case	$R_{\theta JC}$	83.3	$^\circ\text{C}/\text{W}$

Maximum ratings are those values beyond which device damage can occur. Maximum ratings applied to the device are individual stress limit values (not normal operating conditions) and are not valid simultaneously. If these limits are exceeded, device functional operation is not implied, damage may occur and reliability may be affected.

- $R_{\theta JA}$ is measured with the device soldered into a typical printed circuit board.

*For additional information on our Pb-Free strategy and soldering details, please download the ON Semiconductor Soldering and Mounting Techniques Reference Manual, SOLDERRM/D.



ON Semiconductor®

<http://onsemi.com>

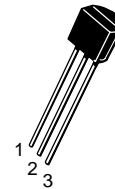
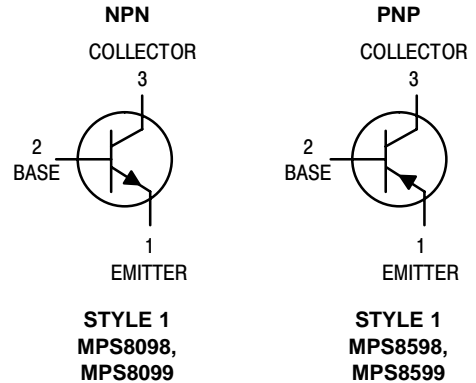

TO-92
CASE 29-11
STYLE 1

MARKING DIAGRAM

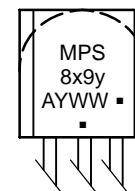

MPS8x9y = Device Code
x = 0 or 5
y = 8 or 9

A = Assembly Location

Y = Year

WW = Work Week

▪ = Pb-Free Package

(Note: Microdot may be in either location)

ORDERING INFORMATION

See detailed ordering and shipping information in the package dimensions section on page 6 of this data sheet.

Preferred devices are recommended choices for future use and best overall value.

(NPN) MPS8098, MPS8099*, (PNP) MPS8598, MPS8599*

ELECTRICAL CHARACTERISTICS (T_A = 25°C unless otherwise noted)

Characteristic	Symbol	Min	Max	Unit	
OFF CHARACTERISTICS					
Collector-Emitter Breakdown Voltage (Note 2) (I _C = 10 mA _{dc} , I _B = 0)	MPS8098, MPS8598 MPS8099, MPS8599	V _{(BR)CEO}	60 80	– –	V _{dc}
Collector-Base Breakdown Voltage (I _C = 100 μA _{dc} , I _E = 0)	MPS8098, MPS8598 MPS8099, MPS8599	V _{(BR)CBO}	60 80	– –	V _{dc}
Emitter-Base Breakdown Voltage (I _E = 10 μA _{dc} , I _C = 0)	MPS8098, MPS8099 MPS8598, MPS8599	V _{(BR)EBO}	6.0 5.0	– –	V _{dc}
Collector Cutoff Current (V _{CE} = 60 V _{dc} , I _B = 0)		I _{CES}	–	0.1	μA _{dc}
Collector Cutoff Current (V _{CB} = 60 V _{dc} , I _E = 0) (V _{CB} = 80 V _{dc} , I _E = 0)	MPS8098, MPS8598 MPS8099, MPS8599	I _{CBO}	– –	0.1 0.1	μA _{dc}
Emitter Cutoff Current (V _{EB} = 6.0 V _{dc} , I _C = 0) (V _{EB} = 4.0 V _{dc} , I _C = 0)	MPS8098, MPS8099 MPS8598, MPS8599	I _{EBO}	– –	0.1 0.1	μA _{dc}

ON CHARACTERISTICS (Note 2)

DC Current Gain (I _C = 1.0 mA _{dc} , V _{CE} = 5.0 V _{dc}) (I _C = 10 mA _{dc} , V _{CE} = 5.0 V _{dc}) (I _C = 100 mA _{dc} , V _{CE} = 5.0 V _{dc})		h _{FE}	100 100 75	300 – –	–
Collector-Emitter Saturation Voltage (I _C = 100 mA _{dc} , I _B = 5.0 mA _{dc}) (I _C = 100 mA _{dc} , I _B = 10 mA _{dc})		V _{CE(sat)}	– –	0.4 0.3	V _{dc}
Base-Emitter On Voltage (I _C = 1.0 mA _{dc} , V _{CE} = 5.0 V _{dc}) (I _C = 10 mA _{dc} , V _{CE} = 5.0 V _{dc})	MPS8098, MPS8598 MPS8099, MPS8599	V _{BE(on)}	0.5 0.6	0.7 0.8	V _{dc}

SMALL-SIGNAL CHARACTERISTICS

Current-Gain – Bandwidth Product (I _C = 10 mA _{dc} , V _{CE} = 5.0 V _{dc} , f = 100 MHz)		f _T	150	–	MHz
Output Capacitance (V _{CB} = 5.0 V _{dc} , I _E = 0, f = 1.0 MHz)	MPS8098, MPS8099 MPS8598, MPS8599	C _{obo}	– –	6.0 8.0	pF
Input Capacitance (V _{EB} = 0.5 V _{dc} , I _C = 0, f = 1.0 MHz)	MPS8098, MPS8099 MPS8598, MPS8599	C _{ibo}	– –	25 30	pF

2. Pulse Test: Pulse Width ≤ 300 μs, Duty Cycle = 2.0%.

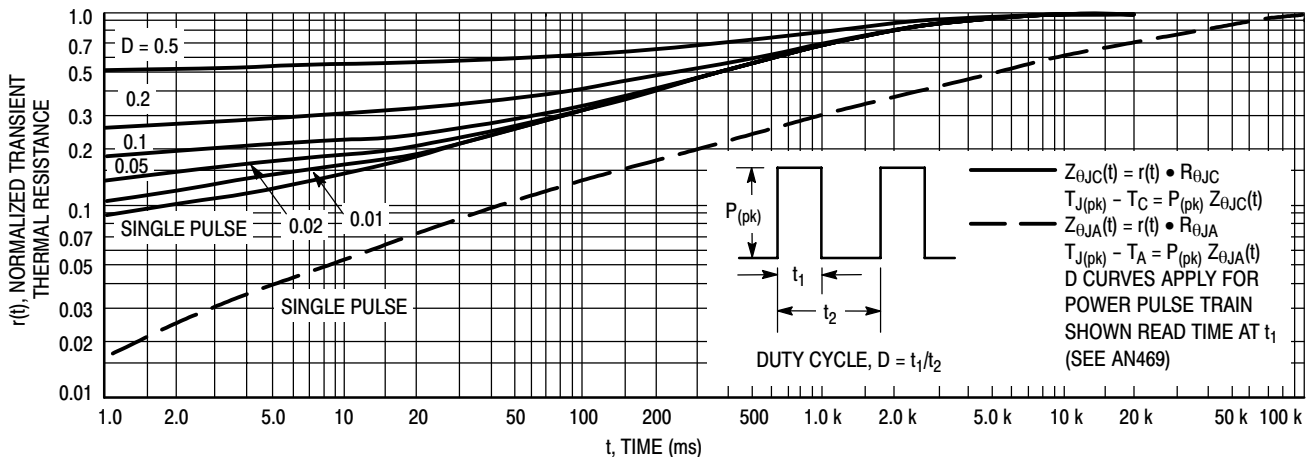
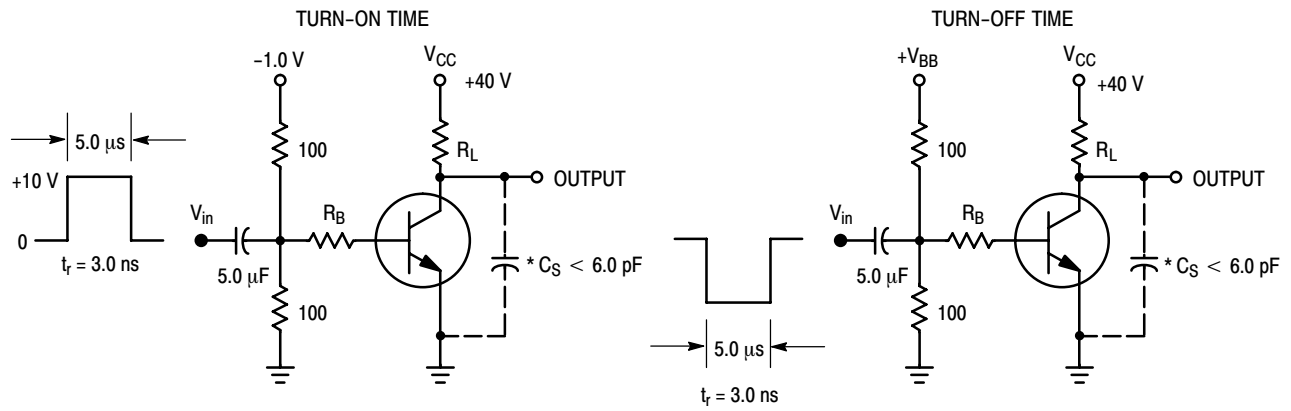

Figure 1. MPS8098, MPS8099, MPS8598 and MPS8599 Thermal Response

(NPN) MPS8098, MPS8099*, (PNP) MPS8598, MPS8599*



*Total Shunt Capacitance of Test Jig and Connectors For PNP Test Circuits, Reverse All Voltage Polarities

Figure 2. Switching Time Test Circuits

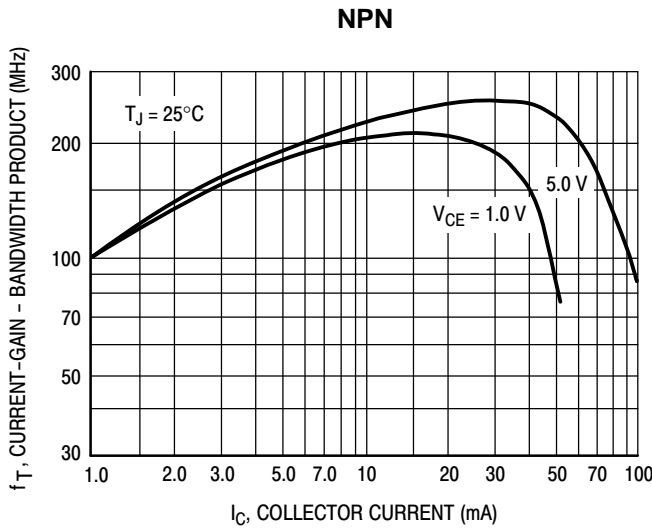

Figure 3. MPS8098/99 Current-Gain - Bandwidth Product

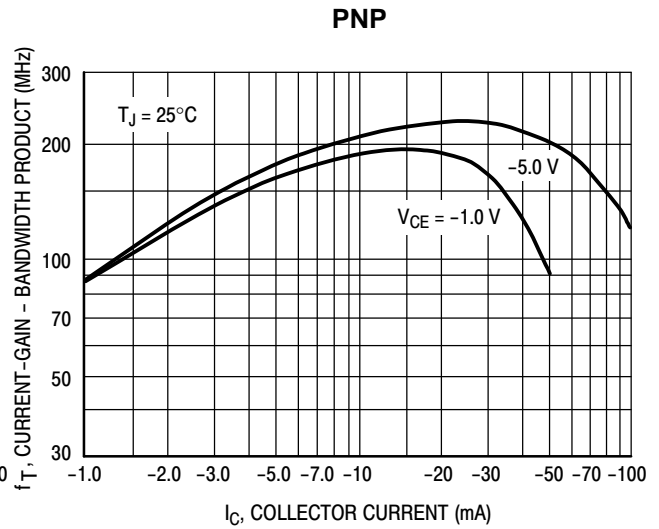

Figure 4. MPS8598/99 Current-Gain - Bandwidth Product

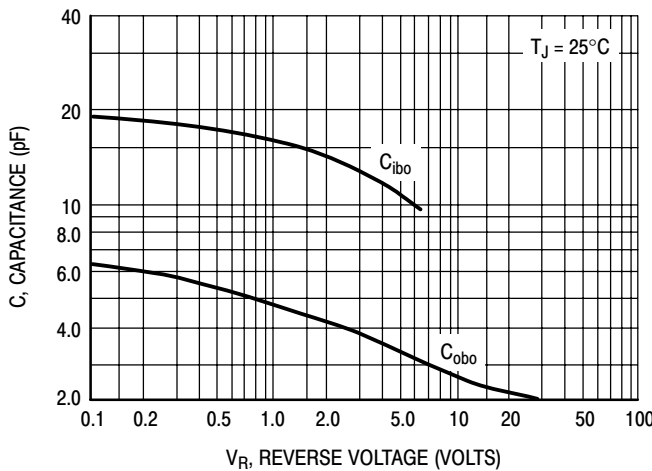

Figure 5. MPS8098/99 Capacitance

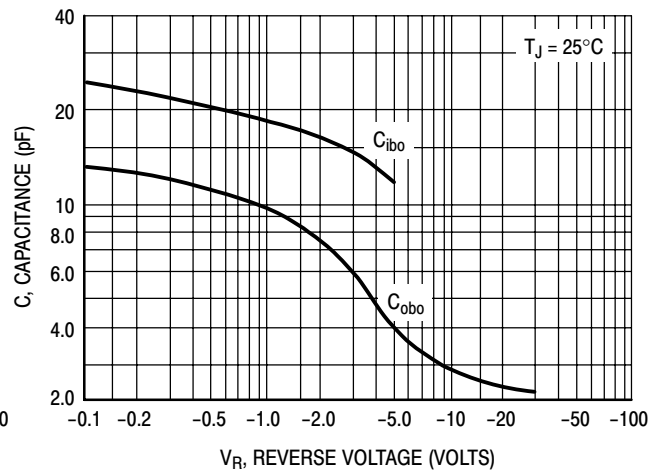

Figure 6. MPS8598/99 Capacitance

(NPN) MPS8098, MPS8099*, (PNP) MPS8598, MPS8599*

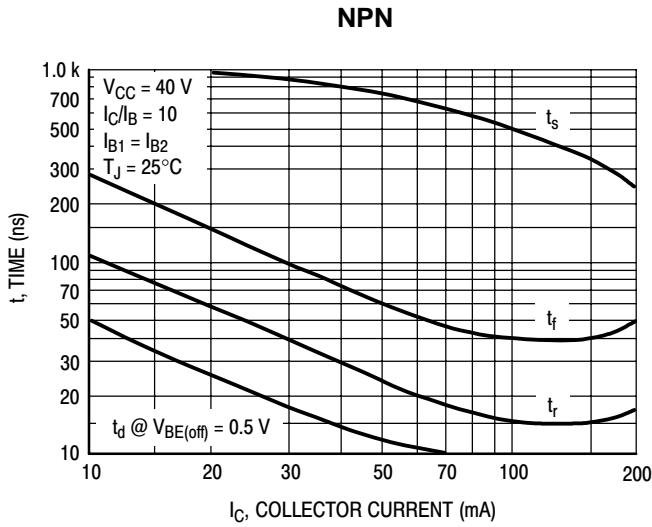

Figure 7. MPS8098/99 Switching Times

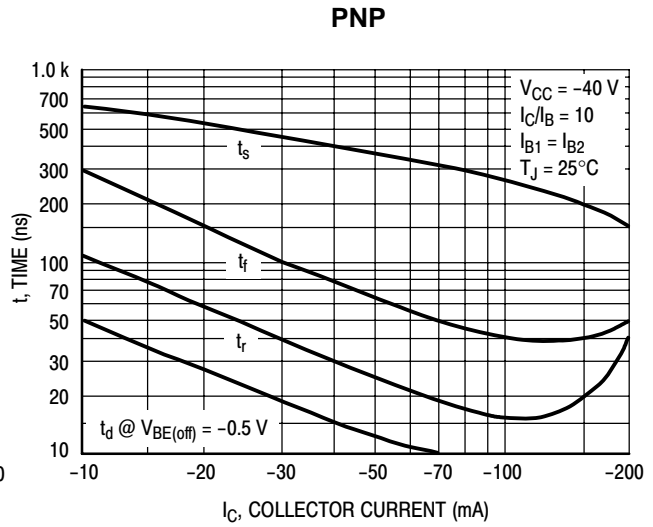

Figure 8. MPS8598/99 Switching Times

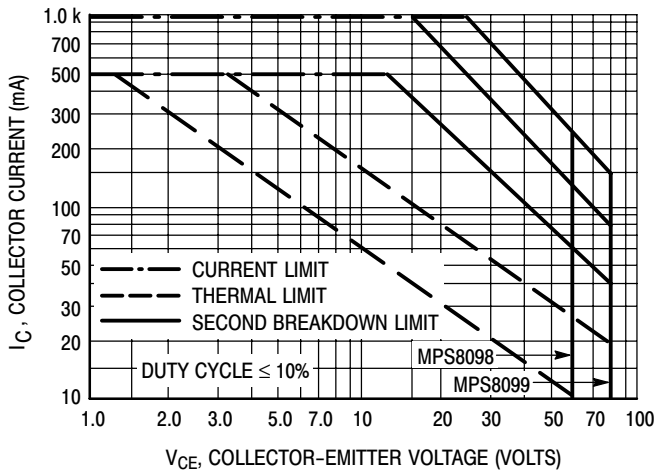

Figure 9. MPS8098/99 Active-Region Safe Operating Area

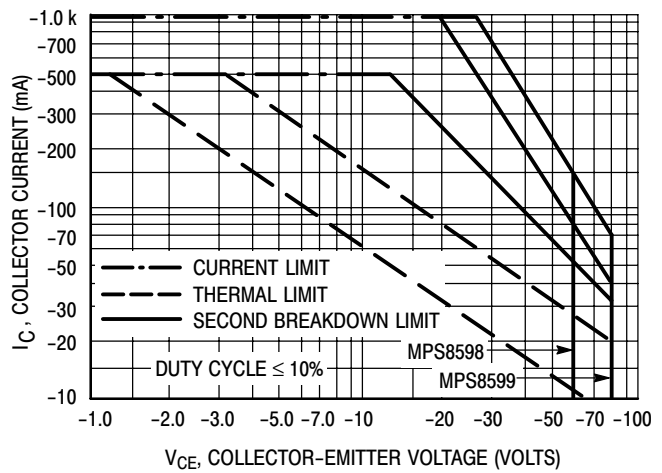

Figure 10. MPS8598/99 Active-Region Safe Operating Area

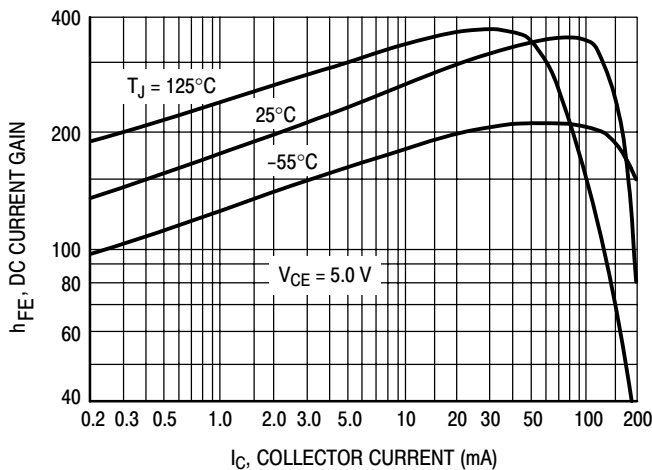

Figure 11. MPS8098/99 DC Current Gain

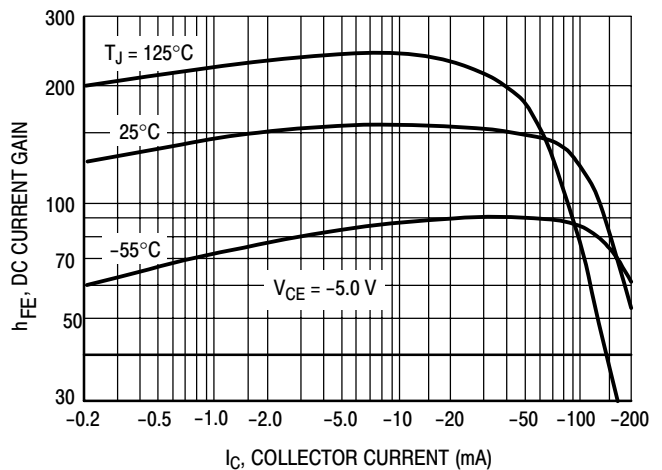

Figure 12. MPS8598/99 DC Current Gain

(NPN) MPS8098, MPS8099*, (PNP) MPS8598, MPS8599*

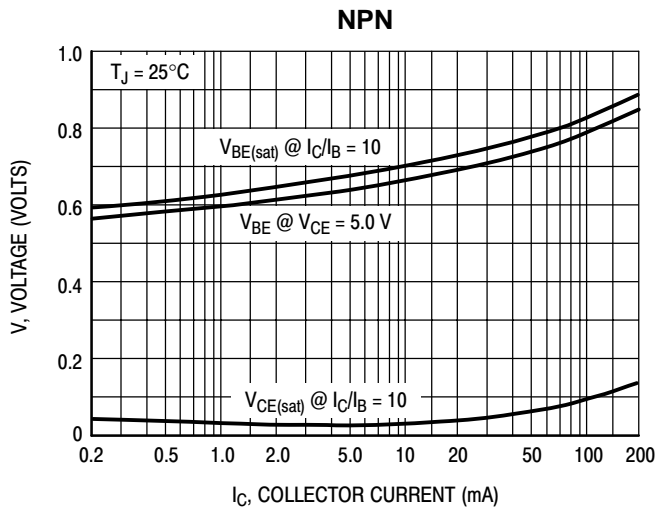

Figure 13. MPS8098/99 "ON" Voltages

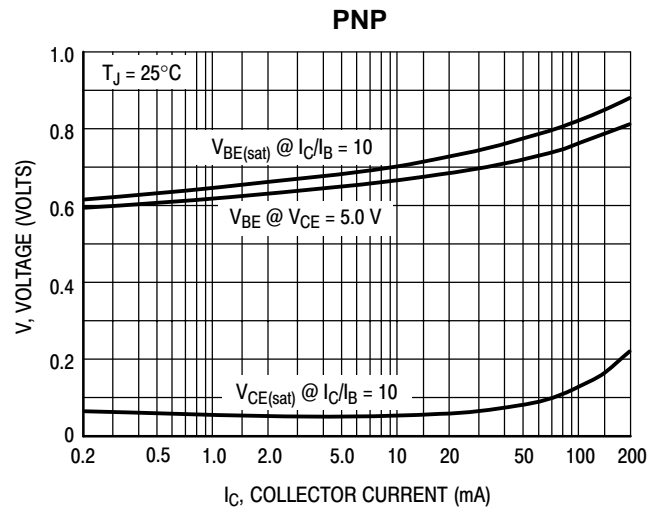

Figure 14. MPS8598/99 "ON" Voltages

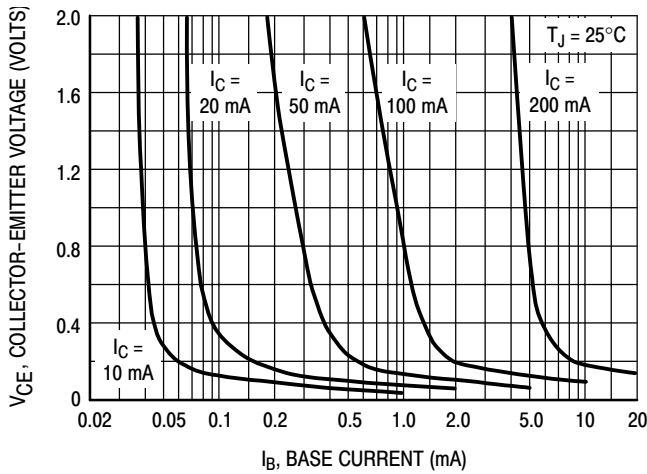

Figure 15. MPS8098/99 Collector Saturation Region

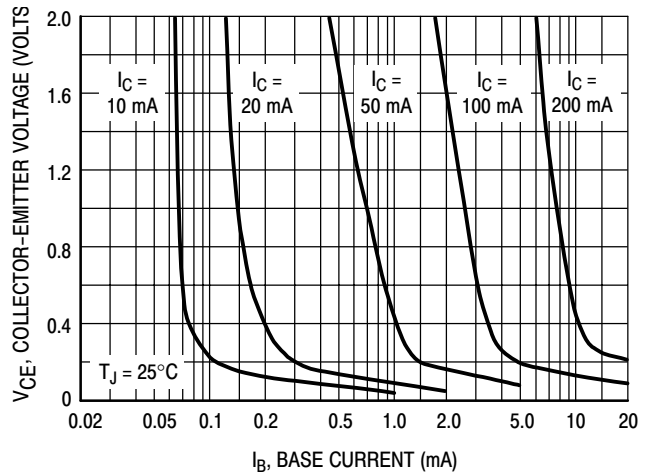

Figure 16. MPS8598/99 Collector Saturation Region

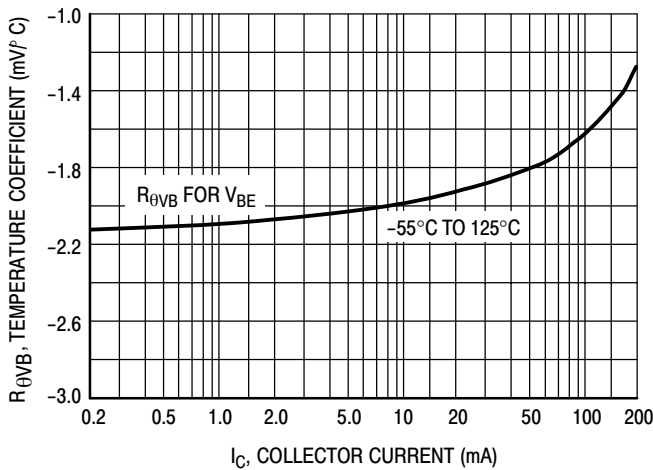

Figure 17. MPS8098/99 Base-Emitter Temperature Coefficient

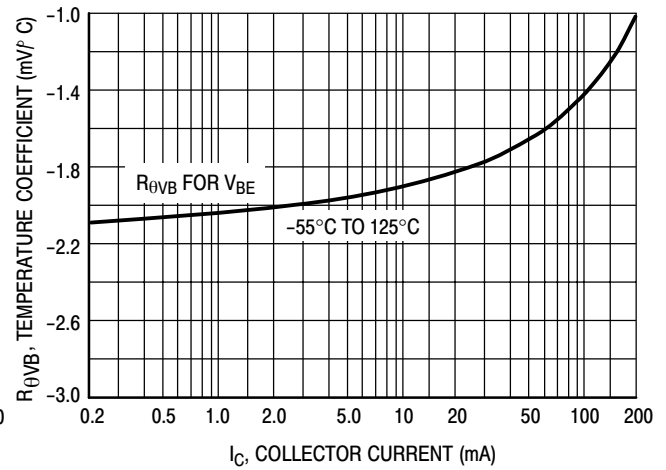

Figure 18. MPS8598/99 Base-Emitter Temperature Coefficient

(NPN) MPS8098, MPS8099*, (PNP) MPS8598, MPS8599***ORDERING INFORMATION**

Device	Package	Shipping†
MPS8098	TO-92	5,000 Units / Box
MPS8098G	TO-92 (Pb-Free)	5,000 Units / Box
MPS8098RLRA	TO-92	2,000 / Tape & Reel
MPS8098RLRAG	TO-92 (Pb-Free)	2,000 / Tape & Reel
MPS8099	TO-92	5,000 Units / Box
MPS8099G	TO-92 (Pb-Free)	5,000 Units / Box
MPS8099RLRA	TO-92	2,000 / Tape & Reel
MPS8099RLRAG	TO-92 (Pb-Free)	2,000 / Tape & Reel
MPS8099RLRM	TO-92	2,000 / Ammo Pack
MPS8099RLRMG	TO-92 (Pb-Free)	2,000 / Ammo Pack
MPS8099RLRP	TO-92	2,000 / Ammo Pack
MPS8099RLRPG	TO-92 (Pb-Free)	2,000 / Ammo Pack
MPS8598	TO-92	5,000 Units / Box
MPS8598G	TO-92 (Pb-Free)	5,000 Units / Box
MPS8598RLRA	TO-92	2,000 / Tape & Reel
MPS8598RLRAG	TO-92 (Pb-Free)	2,000 / Tape & Reel
MPS8599	TO-92	5,000 Units / Box
MPS8599G	TO-92 (Pb-Free)	5,000 Units / Box
MPS8599RLRA	TO-92	2,000 / Tape & Reel
MPS8599RLRAG	TO-92 (Pb-Free)	2,000 / Tape & Reel
MPS8599RLRM	TO-92	2,000 / Ammo Pack
MPS8599RLRMG	TO-92 (Pb-Free)	2,000 / Ammo Pack

†For information on tape and reel specifications, including part orientation and tape sizes, please refer to our Tape and Reel Packaging Specification Brochure, BRD8011/D.

(NPN) MPS8098, MPS8099*, (PNP) MPS8598, MPS8599*

PACKAGE DIMENSIONS

TO-92 (TO-226)
CASE 29-11
ISSUE AL

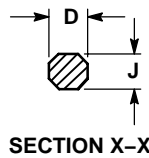
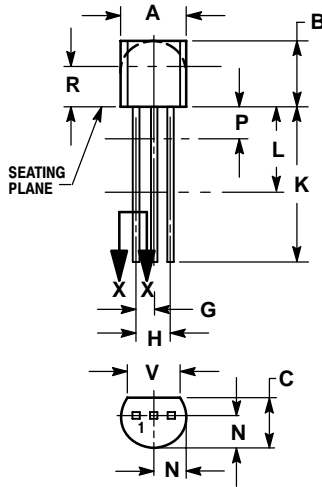

NOTES:

1. DIMENSIONING AND TOLERANCING PER ANSI Y14.5M, 1982.
2. CONTROLLING DIMENSION: INCH.
3. CONTOUR OF PACKAGE BEYOND DIMENSION R IS UNCONTROLLED.
4. LEAD DIMENSION IS UNCONTROLLED IN P AND BEYOND DIMENSION K MINIMUM.

DIM	INCHES		MILLIMETERS	
	MIN	MAX	MIN	MAX
A	0.175	0.205	4.45	5.20
B	0.170	0.210	4.32	5.33
C	0.125	0.165	3.18	4.19
D	0.016	0.021	0.407	0.533
G	0.045	0.055	1.15	1.39
H	0.095	0.105	2.42	2.66
J	0.015	0.020	0.39	0.50
K	0.500	---	12.70	---
L	0.250	---	6.35	---
N	0.080	0.105	2.04	2.66
P	---	0.100	---	2.54
R	0.115	---	2.93	---
V	0.135	---	3.43	---

STYLE 1:

1. PIN 1. EMITTER
2. BASE
3. COLLECTOR

ON Semiconductor and are registered trademarks of Semiconductor Components Industries, LLC (SCILLC). SCILLC reserves the right to make changes without further notice to any products herein. SCILLC makes no warranty, representation or guarantee regarding the suitability of its products for any particular purpose, nor does SCILLC assume any liability arising out of the application or use of any product or circuit, and specifically disclaims any and all liability, including without limitation special, consequential or incidental damages. "Typical" parameters which may be provided in SCILLC data sheets and/or specifications can and do vary in different applications and actual performance may vary over time. All operating parameters, including "Typicals" must be validated for each customer application by customer's technical experts. SCILLC does not convey any license under its patent rights nor the rights of others. SCILLC products are not designed, intended, or authorized for use as components in systems intended for surgical implant into the body, or other applications intended to support or sustain life, or for any other application in which the failure of the SCILLC product could create a situation where personal injury or death may occur. Should Buyer purchase or use SCILLC products for any such unintended or unauthorized application, Buyer shall indemnify and hold SCILLC and its officers, employees, subsidiaries, affiliates, and distributors harmless against all claims, costs, damages, and expenses, and reasonable attorney fees arising out of, directly or indirectly, any claim of personal injury or death associated with such unintended or unauthorized use, even if such claim alleges that SCILLC was negligent regarding the design or manufacture of the part. SCILLC is an Equal Opportunity/Affirmative Action Employer. This literature is subject to all applicable copyright laws and is not for resale in any manner.

PUBLICATION ORDERING INFORMATION

LITERATURE FULFILLMENT:

Literature Distribution Center for ON Semiconductor
P.O. Box 61312, Phoenix, Arizona 85082-1312 USA
Phone: 480-829-7710 or 800-344-3860 Toll Free USA/Canada
Fax: 480-829-7709 or 800-344-3867 Toll Free USA/Canada
Email: orderlit@onsemi.com

N. American Technical Support: 800-282-9855 Toll Free
USA/Canada

Japan: ON Semiconductor, Japan Customer Focus Center
2-9-1 Kamimeguro, Meguro-ku, Tokyo, Japan 153-0051
Phone: 81-3-5773-3850

ON Semiconductor Website: <http://onsemi.com>

Order Literature: <http://www.onsemi.com/litorder>

For additional information, please contact your
local Sales Representative.