

REV	ECN	APP'D
-	6299	HT 5-29-09

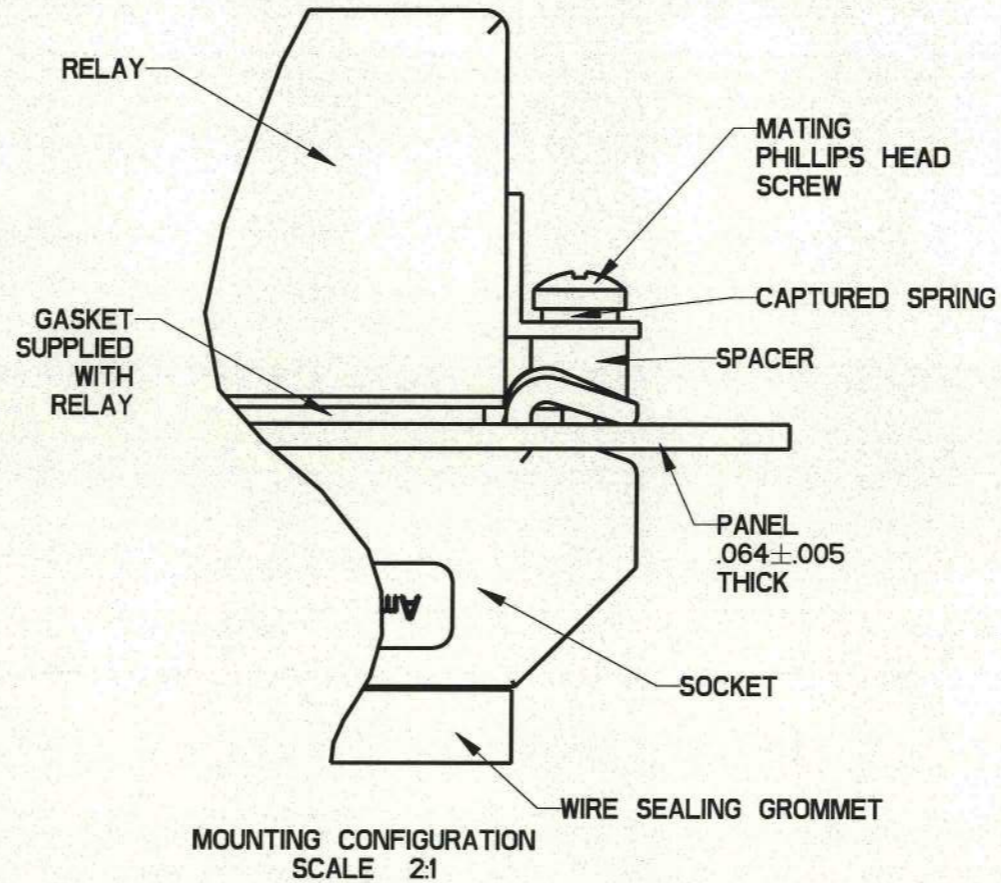

- NOTES:
- MATERIALS:
HOUSING: POLYETHERIMIDE PER ASTM-D5205
GROMMET: SILICONE RUBBER PER A-A-59588
THREADED INSERT: STAINLESS STEEL
 - OPERATING RANGE:
TEMPERATURE: -65 °C TO 125 °C
INSULATION RESISTANCE: 1000 MEGOHMS MIN.
DIELECTRIC WITHSTANDING VOLTAGE: 1500 VRMS AT SEA LEVEL AND 500 VRMS AT 80,000 FT. ALTITUDE
VIBRATION: MIL-STD-202, METHOD 204, TEST CONDITION G
SHOCK: MIL-STD-202, METHOD 213, TEST CONDITION C
 - PART ACCEPTS M39029/92-533 AND M39029/92-534 SOCKET CONTACTS, SIZE 16/16 AND SIZE 16/20.

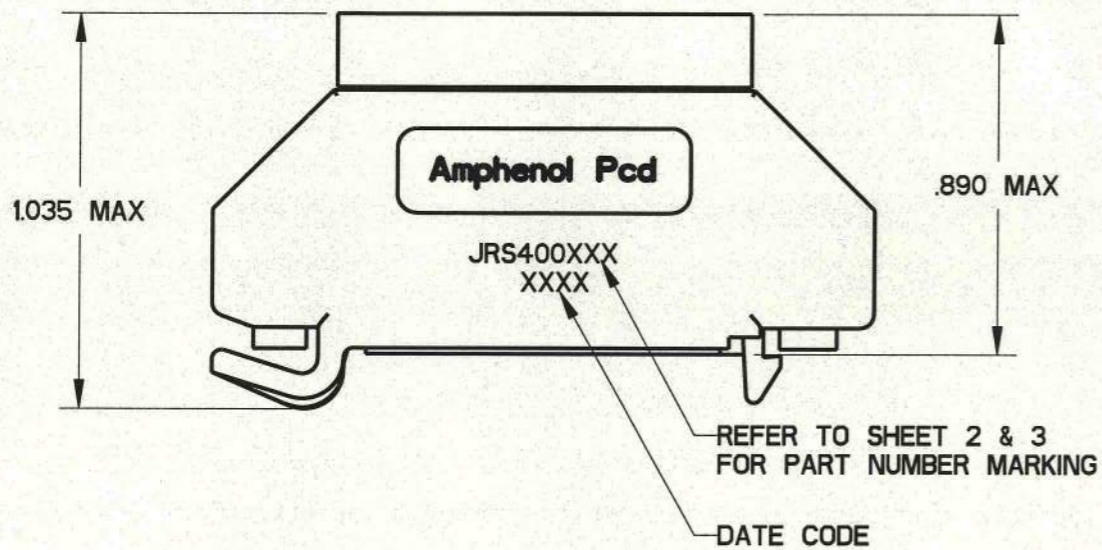
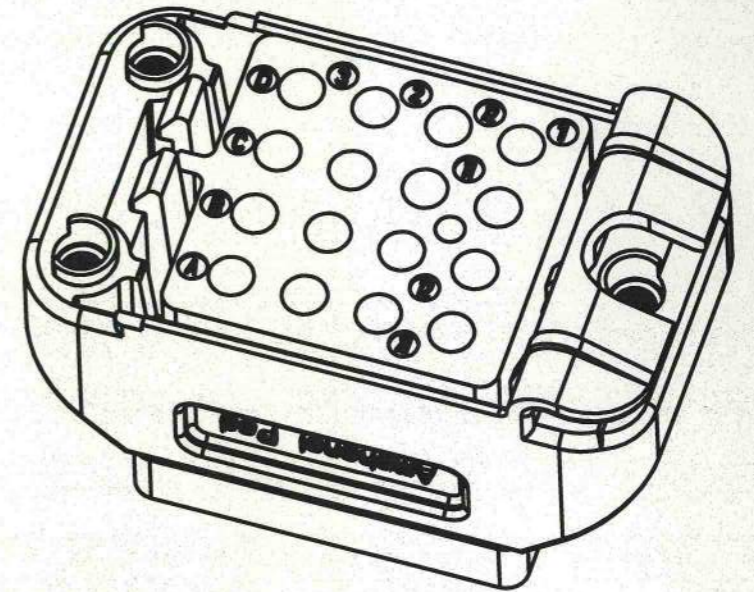
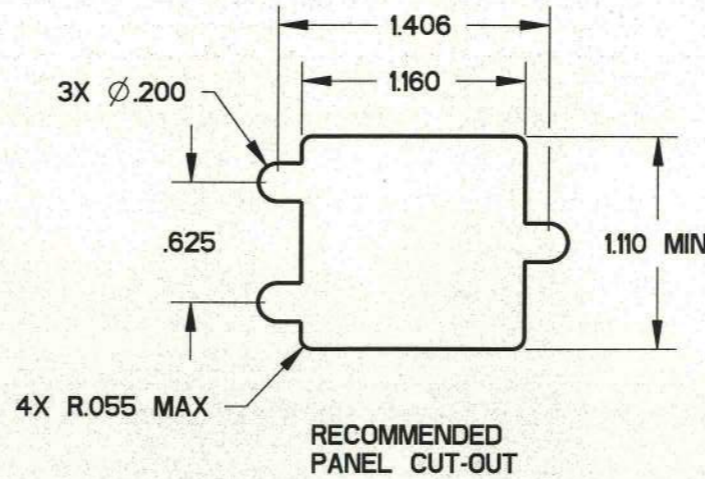
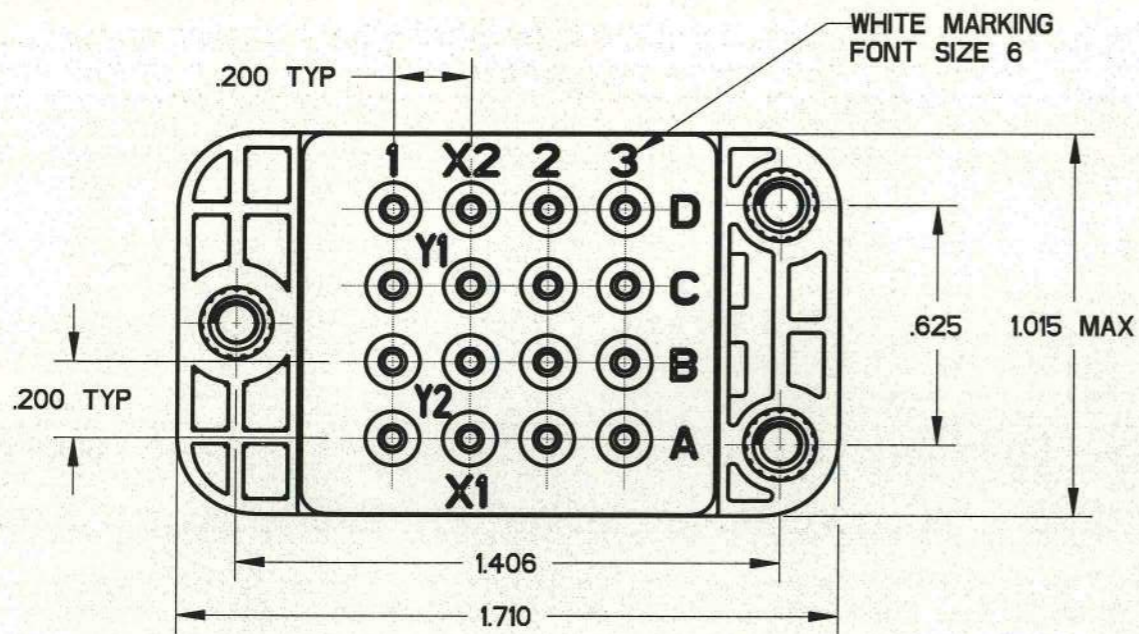
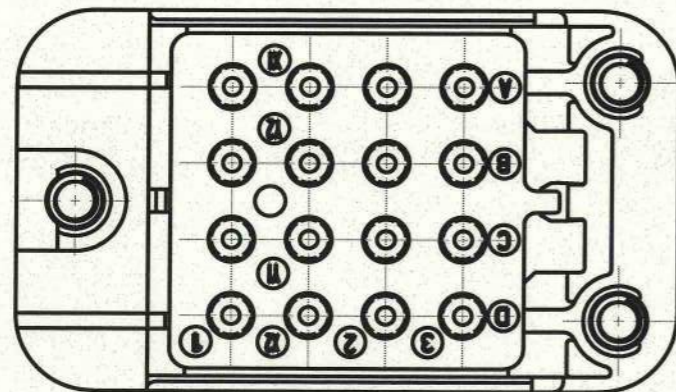

DIMENSIONS ANSI Y14.5M UNITS: INCHES Pro/E FILE	TOLERANCES .XX ±0.01 .XXX ±0.005 ANGLES ±1.0°	PROJECTION 	Amphenol Pcd SPECIFICATION DRAWING		TITLE SNAP-IN RELAY SOCKET 4 POLE		
			ENGR Frank.Li 07-Apr-08	SIZE B DWG NO. JRS400100 REV -			
ORIGINAL 	THIS DOCUMENT CONTAINS PROPRIETARY INFORMATION WHICH IS THE CONFIDENTIAL PROPERTY OF AMPHENOL PCD INC., BEVERLY, MA		CHKD 5/25/09	APPD 5-29-09	CODE: 58982	SCALE: 2:1	SHEET 1 OF 3

JRS400100

JRS400100

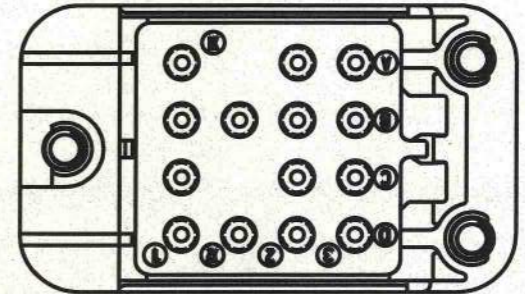
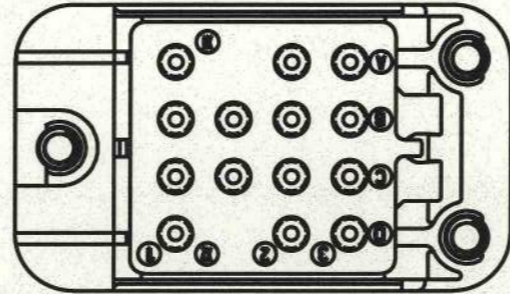
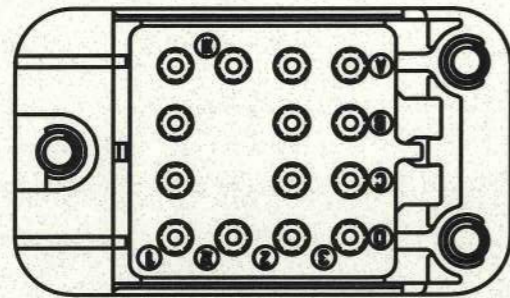
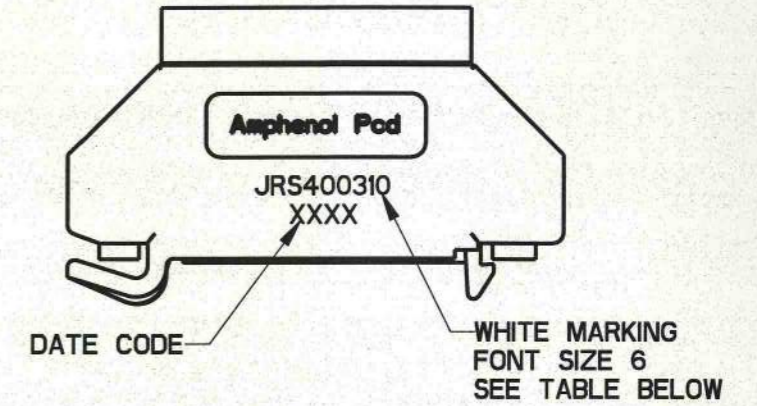
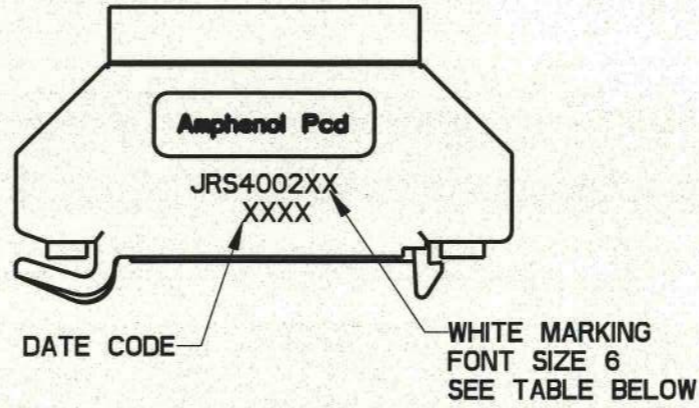
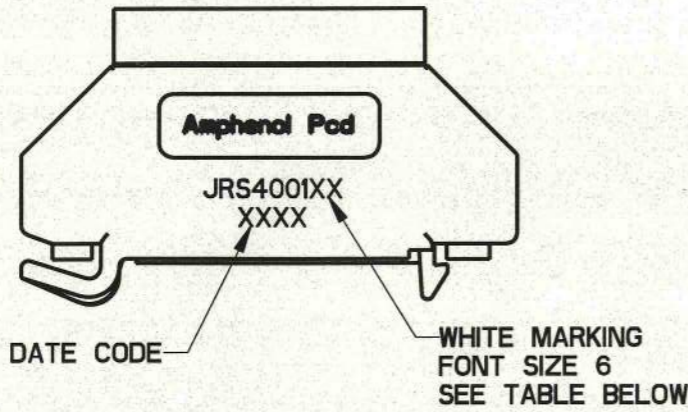
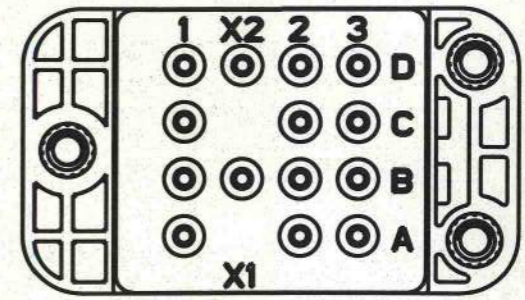
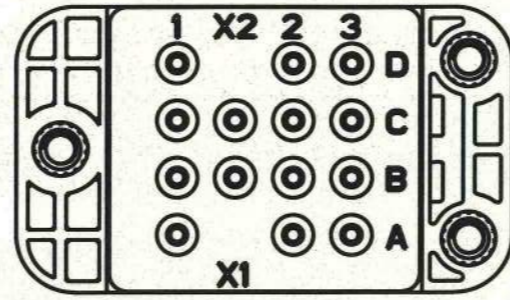
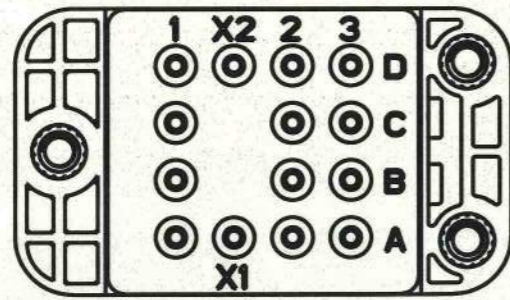

JRS4001XX

JRS4002XX

JRS4003XX

PART NUMBER TABLE

APCD P/N	HARDWARE PACKAGE	CONTACTS SUPPLIED
JRS400100	NONE	NONE
JRS400101	NONE	YES
JRS400110	YES	NONE
JRS400111	YES	YES

PART NUMBER TABLE

APCD P/N	HARDWARE PACKAGE	CONTACTS SUPPLIED
JRS400200	NONE	NONE
JRS400201	NONE	YES
JRS400210	YES	NONE
JRS400211	YES	YES

PART NUMBER TABLE

APCD P/N	HARDWARE PACKAGE	CONTACTS SUPPLIED
JRS400300	NONE	NONE
JRS400301	NONE	YES
JRS400310	YES	NONE
JRS400311	YES	YES

SIZE B	DWG NO. JRS400100	REV -
CODE: 58982	SCALE: 2:1	SHEET 2 OF 3

JRS400100

JRS400100

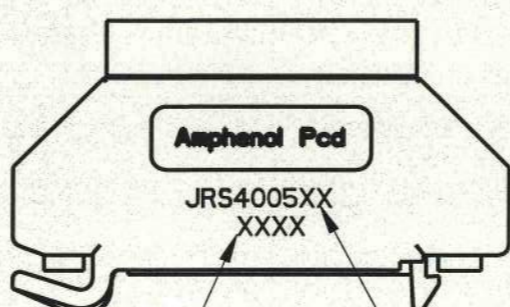
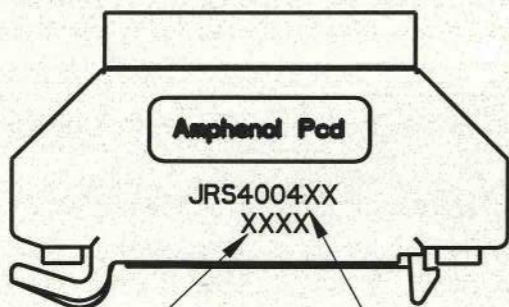
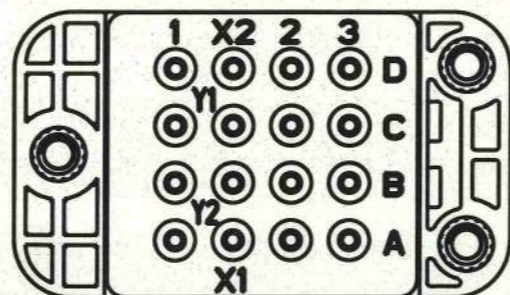
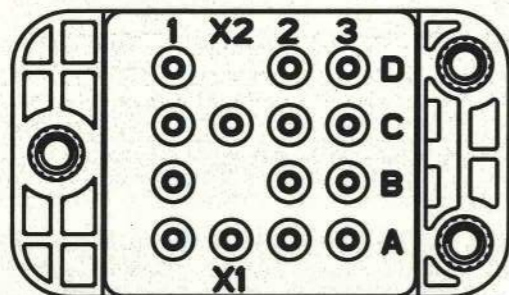

DATE CODE → WHITE MARKING
FONT SIZE 6
SEE TABLE BELOW

DATE CODE → WHITE MARKING
FONT SIZE 6
SEE TABLE BELOW

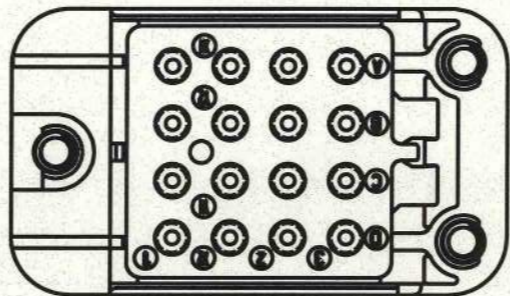
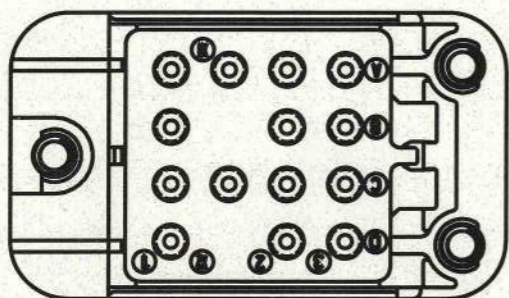

JRS4004XX

JRS4005XX

PART NUMBER TABLE

APCD P/N	HARDWARE PACKAGE	CONTACTS SUPPLIED
JRS400400	NONE	NONE
JRS400401	NONE	YES
JRS400410	YES	NONE
JRS400411	YES	YES

PART NUMBER TABLE

APCD P/N	HARDWARE PACKAGE	CONTACTS SUPPLIED
JRS400500	NONE	NONE
JRS400501	NONE	YES
JRS400510	YES	NONE
JRS400511	YES	YES

JRS400100

JRS400100

SIZE B	DWG NO. JRS400100	REV -
CODE: 58982	SCALE: 2:1	SHEET 3 OF 3