

BLF0910H9LS750P

Power LDMOS transistor

Rev. 2 — 18 June 2019

AMPLEON

Product data sheet

1. Product profile

1.1 General description

A 750 W LDMOS power transistor for industrial applications at frequency of 915 MHz.

The BLF0910H9LS750P is designed for high-power CW applications and is assembled in a high performance ceramic package.

Table 1. Typical performance

RF performance at $V_{DS} = 50\text{ V}$; $I_{DQ} = 50\text{ mA}$ per section in a class-AB application circuit.

Test signal	f	V_{DS}	P_L	G_p	η_D
	(MHz)	(V)	(W)	(dB)	(%)
CW [1]	915	50	750	21.5	72.5
CW [2]	902 to 928	50	800	21	69
CW pulsed [3]	915	50	850	21.3	70

[1] Narrowband circuit.

[2] Broadband circuit.

[3] Broadband circuit: $t_p = 100\ \mu\text{s}$; $\delta = 10\%$; $t_r = 150\text{ ns}$; $t_f = 150\text{ ns}$.

1.2 Features and benefits

- High efficiency
- Easy power control
- Excellent ruggedness
- Integrated ESD protection
- Designed for broadband operation (902 MHz to 928 MHz)
- Internally input matched
- For RoHS compliance see the product details on the Ampleon website

1.3 Applications

- Industrial applications in the 915 MHz ISM band
- Professional applications in the 915 MHz ISM band

2. Pinning information

Table 2. Pinning

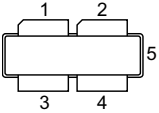
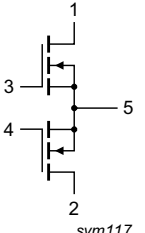
Pin	Description	Simplified outline	Graphic symbol
1	drain1		 sym117
2	drain2		
3	gate1		
4	gate2		
5	source [1]		

[1] Connected to flange.

3. Ordering information

Table 3. Ordering information

Type number	Package		
	Name	Description	Version
BLF0910H9LS750P	-	earless flanged balanced ceramic package; 4 leads	SOT539B

4. Limiting values

Table 4. Limiting values

In accordance with the Absolute Maximum Rating System (IEC 60134).

Symbol	Parameter	Min	Max	Unit
V_{DS}	drain-source voltage	-	108	V
V_{GS}	gate-source voltage	-6	+11	V
T_{stg}	storage temperature	-65	+150	°C
T_j	junction temperature [1]	-	225	°C

[1] Continuous use at maximum temperature will affect the reliability, for details refer to the online MTF calculator.

5. Thermal characteristics

Table 5. Thermal characteristics

Symbol	Parameter	Conditions	Typ	Unit
$R_{th(j-c)}$	thermal resistance from junction to case	$T_{case} = 90\text{ °C}; P_L = 750\text{ W}$	0.15	K/W

6. Characteristics

Table 6. DC characteristics

$T_j = 25\text{ }^\circ\text{C}$; unless otherwise specified.

Symbol	Parameter	Conditions	Min	Typ	Max	Unit
$V_{(BR)DSS}$	drain-source breakdown voltage	$V_{GS} = 0\text{ V}; I_D = 2.4\text{ mA}$	108	-	-	V
$V_{GS(th)}$	gate-source threshold voltage	$V_{DS} = 10\text{ V}; I_D = 240\text{ mA}$	1.5	2.1	2.5	V
I_{DSS}	drain leakage current	$V_{GS} = 0\text{ V}; V_{DS} = 50\text{ V}$	-	-	2.8	μA
I_{DSX}	drain cut-off current	$V_{GS} = V_{GS(th)} + 3.75\text{ V}; V_{DS} = 10\text{ V}$	-	44.5	-	A
I_{GSS}	gate leakage current	$V_{GS} = 10\text{ V}; V_{DS} = 0\text{ V}$	-	-	280	nA
$R_{DS(on)}$	drain-source on-state resistance	$V_{GS} = V_{GS(th)} + 3.75\text{ V}; I_D = 8.4\text{ A}$	-	90	-	$\text{m}\Omega$

Table 7. RF characteristics

Test signal: CW pulsed; $f = 915\text{ MHz}$; RF performance at $V_{DS} = 50\text{ V}; I_{Dq} = 50\text{ mA}$ per section; $T_{case} = 25\text{ }^\circ\text{C}$; unless otherwise specified; in a class-AB production test circuit.

Symbol	Parameter	Conditions	Min	Typ	Max	Unit
G_p	power gain	$P_L = 750\text{ W}$	20	21.5	-	dB
RL_{in}	input return loss	$P_L = 750\text{ W}$	-	-13	-10	dB
η_D	drain efficiency	$P_L = 750\text{ W}$	62.5	65	-	%

7. Test information

7.1 Ruggedness in class-AB operation

The BLF0910H9LS750P is capable of withstanding a load mismatch corresponding to $VSWR = 10 : 1$ through all phases under the following conditions: $V_{DS} = 50\text{ V}; I_{Dq} = 50\text{ mA}$ per section; $P_L = 750\text{ W}$ (CW); tested in band across predefined integer phase steps (narrowband circuit).

7.2 Impedance information

Table 8. Typical impedance

Measured load-pull Z_S and Z_L device impedances per section; $I_{Dq} = 50\text{ mA}$ per section; $V_{DS} = 50\text{ V}$; typical values unless otherwise specified.

f (MHz)	Z_S [1] (Ω)	Z_L [1] (Ω)
915	$1.7 - 2.3j$	$0.9 + 0.7j$

[1] Z_S and Z_L defined in [Figure 1](#).

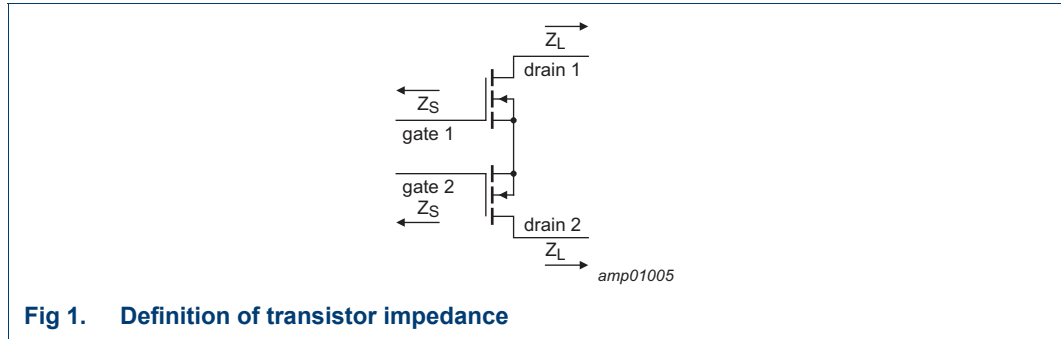

7.3 Test circuit broadband

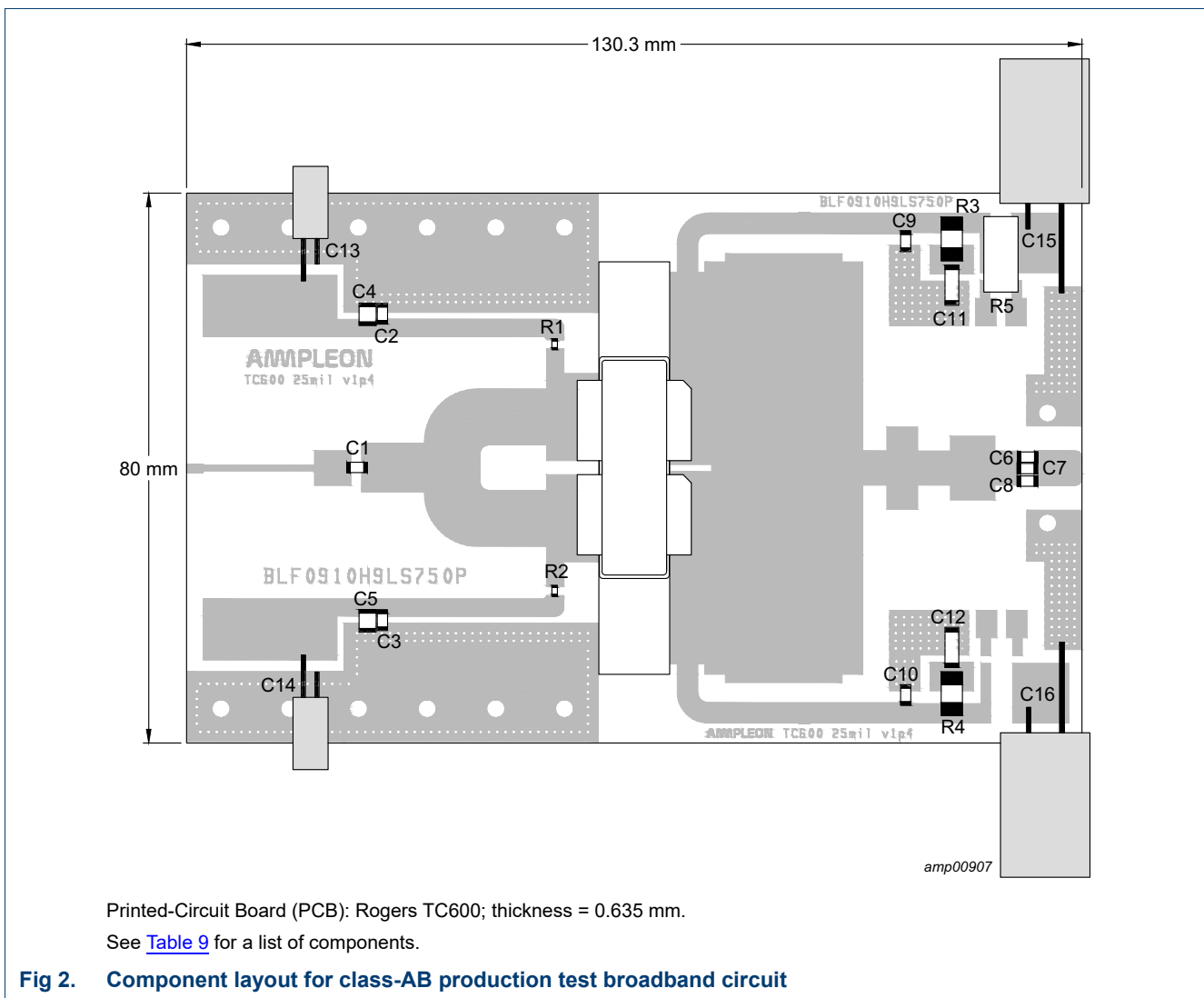

Table 9. List of components

For test circuit see [Figure 2](#).

Component	Description	Value	Remarks
C1, C2, C3, C6, C7, C8	multilayer ceramic chip capacitor	560 pF	ATC 800B
C4, C5	multilayer ceramic chip capacitor	1 μ F, 50 V	GRM32RR71H105KA01L
C9, C10	multilayer ceramic chip capacitor	47 pF	ATC 100B
C11, C12	multilayer ceramic chip capacitor	4.7 μ F, 100 V	TDK: C5750X7R2A475KT/A
C13, C14	electrolytic capacitor	10 μ F, 63 V	
C15, C16	electrolytic capacitor	470 μ F, 63 V	
R1, R2	chip resistor	10 Ω	SMD806
R3, R4	chip resistor	3.3 Ω	Bourns: CRS2512
R5	shunt resistor	0.01 Ω	Ohmite: FC4L110R010FER

7.4 Graphical data broadband circuit

7.4.1 CW

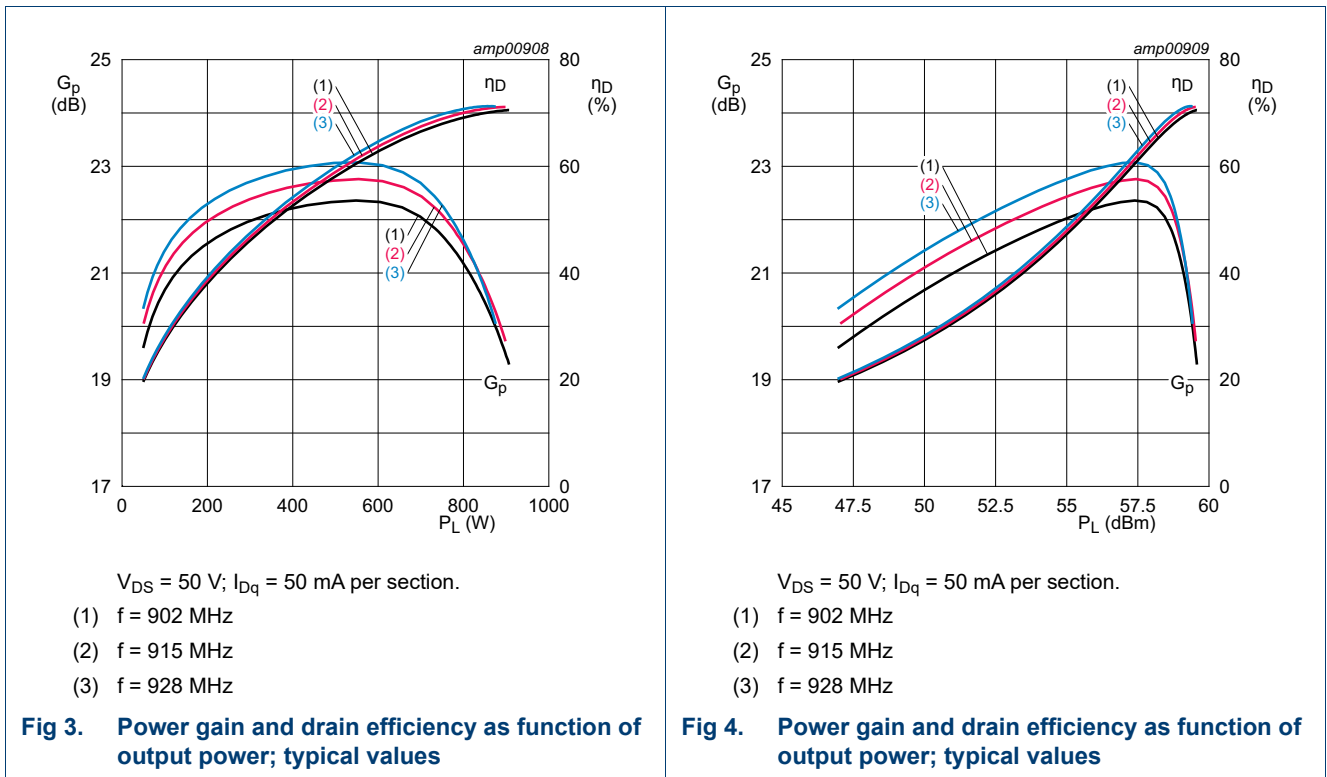

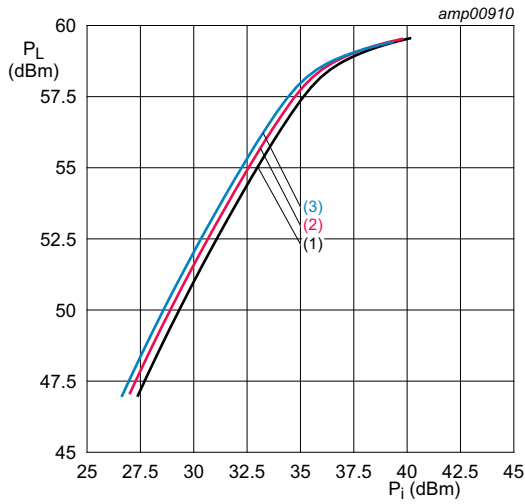

$V_{DS} = 50\text{ V}$; $I_{Dq} = 50\text{ mA}$ per section.

- (1) $f = 902\text{ MHz}$
- (2) $f = 915\text{ MHz}$
- (3) $f = 928\text{ MHz}$

Fig 5. Output power as a function of input power; typical values

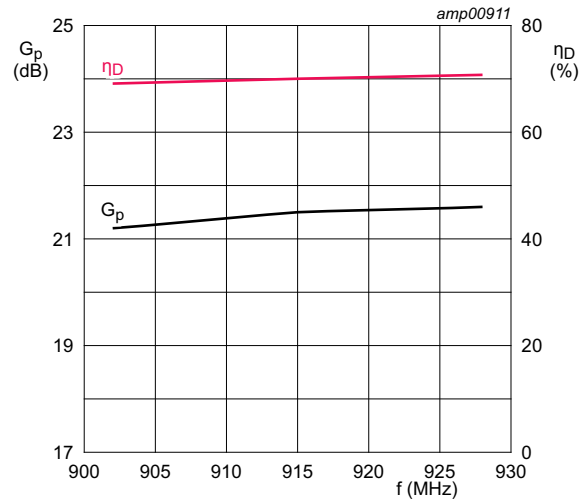

$V_{DS} = 50\text{ V}$; $I_{Dq} = 50\text{ mA}$ per section; $P_L = 800\text{ W}$.

Fig 6. Power gain and drain efficiency as function of frequency; typical values

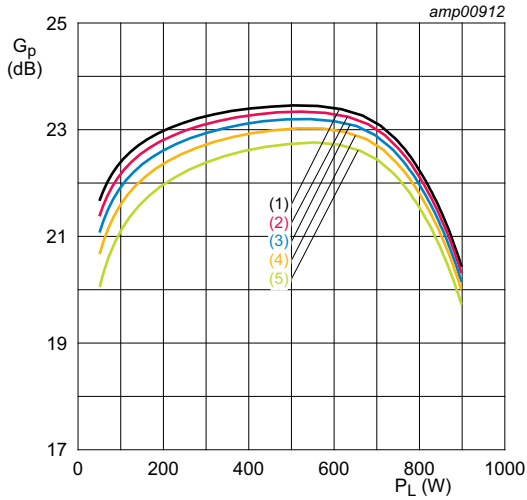

$V_{DS} = 50\text{ V}$; $f = 915\text{ MHz}$.

- (1) $I_{Dq} = 250\text{ mA}$ per section
- (2) $I_{Dq} = 200\text{ mA}$ per section
- (3) $I_{Dq} = 150\text{ mA}$ per section
- (4) $I_{Dq} = 100\text{ mA}$ per section
- (5) $I_{Dq} = 50\text{ mA}$ per section

Fig 7. Power gain as a function of output power; typical values

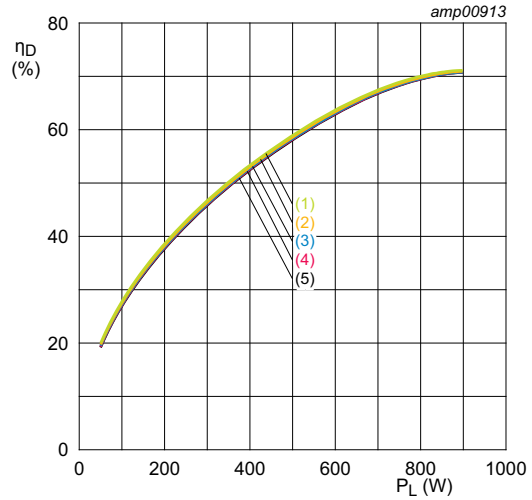

$V_{DS} = 50\text{ V}$; $f = 915\text{ MHz}$.

- (1) $I_{Dq} = 250\text{ mA}$ per section
- (2) $I_{Dq} = 200\text{ mA}$ per section
- (3) $I_{Dq} = 150\text{ mA}$ per section
- (4) $I_{Dq} = 100\text{ mA}$ per section
- (5) $I_{Dq} = 50\text{ mA}$ per section

Fig 8. Drain efficiency as a function of output power; typical values

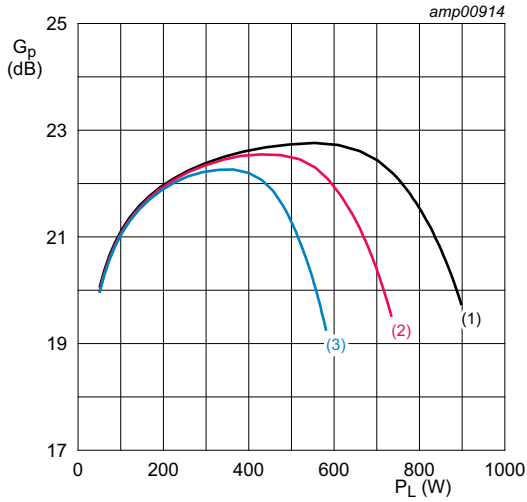

$I_{Dq} = 50$ mA per section; $f = 915$ MHz.
 (1) $V_{DS} = 50$ V
 (2) $V_{DS} = 45$ V
 (3) $V_{DS} = 40$ V

Fig 9. Power gain as a function of output power; typical values

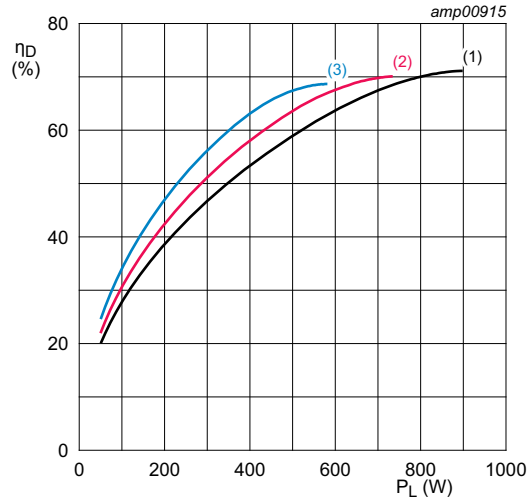

$I_{Dq} = 50$ mA per section; $f = 915$ MHz.
 (1) $V_{DS} = 50$ V
 (2) $V_{DS} = 45$ V
 (3) $V_{DS} = 40$ V

Fig 10. Drain efficiency as a function of output power; typical values

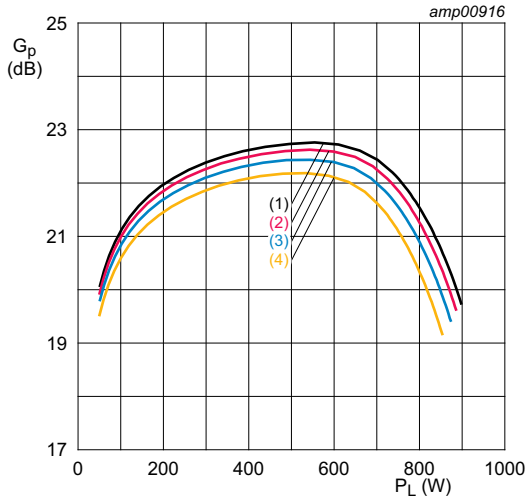

$V_{DS} = 50$ V; $I_{Dq} = 50$ mA per section; $f = 915$ MHz.
 (1) $T = 25$ °C
 (2) $T = 35$ °C
 (3) $T = 45$ °C
 (4) $T = 55$ °C

Fig 11. Power gain as a function of output power; typical values

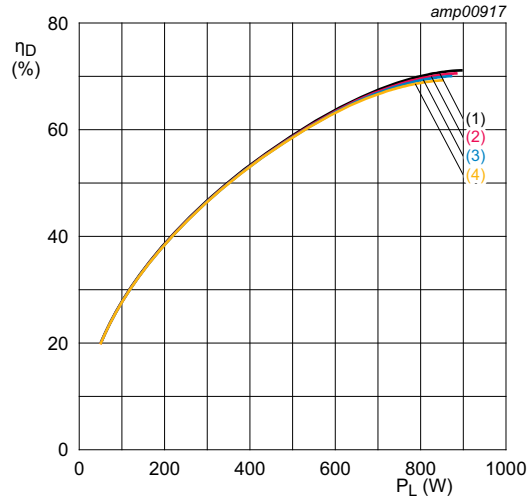

$V_{DS} = 50$ V; $I_{Dq} = 50$ mA per section; $f = 915$ MHz.
 (1) $T = 25$ °C
 (2) $T = 35$ °C
 (3) $T = 45$ °C
 (4) $T = 55$ °C

Fig 12. Drain efficiency as a function of output power; typical values

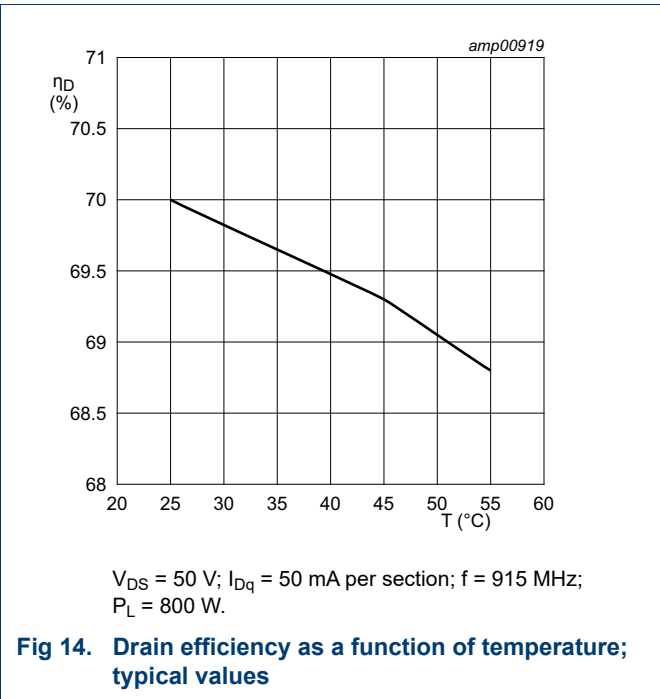
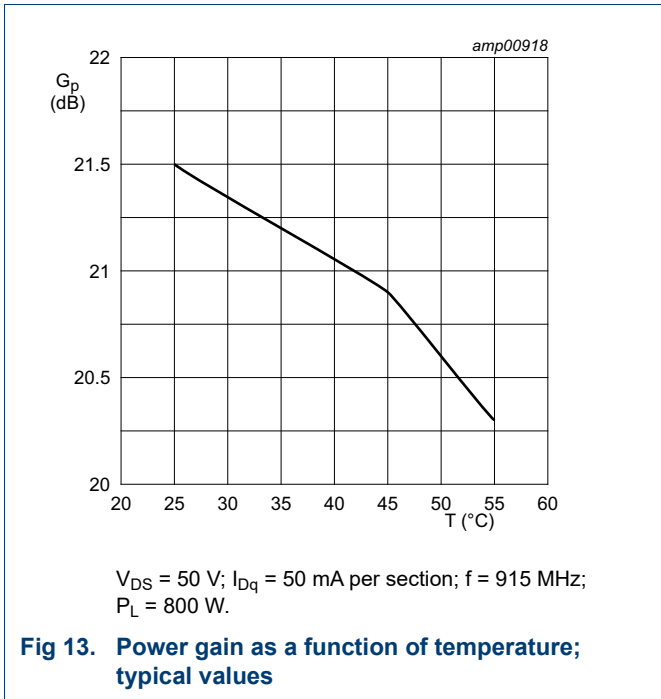

7.5 Test circuit narrowband

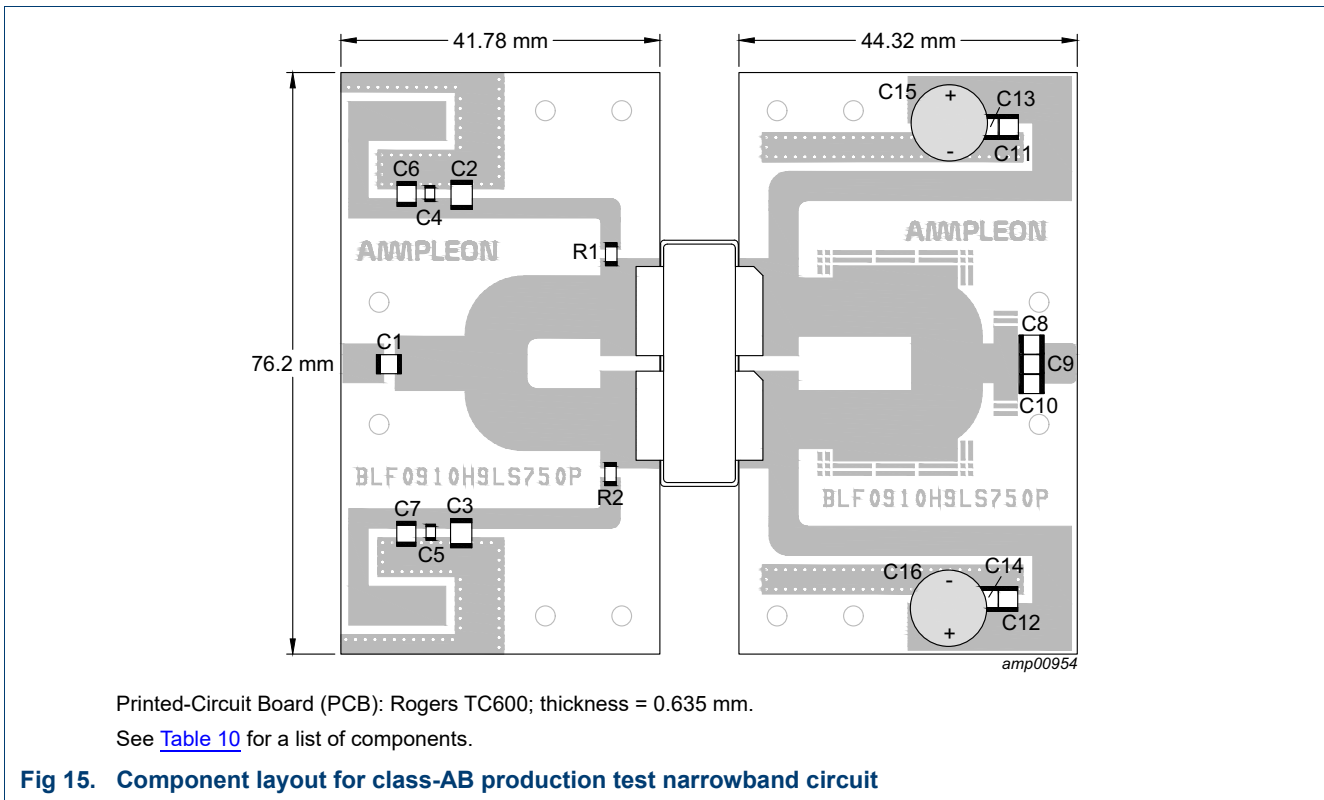

Table 10. List of components

For test circuit see [Figure 15](#).

Component	Description	Value	Remarks
C1, C2, C3, C8, C9, C10, C11, C12	multilayer ceramic chip capacitor	47 pF	ATC 100B
C4, C5, C13, C14	multilayer ceramic chip capacitor	1000 pF, 100 V	Multicomp: MCMT21N02F101CT
C6, C7	multilayer ceramic chip capacitor	1 μ F, 50 V	GRM32RR71H105KA01L
C15, C16	electrolytic capacitor	470 μ F, 63 V	
R1, R2	chip resistor	10 Ω	SMD1206

7.6 Graphical data narrowband circuit

7.6.1 CW

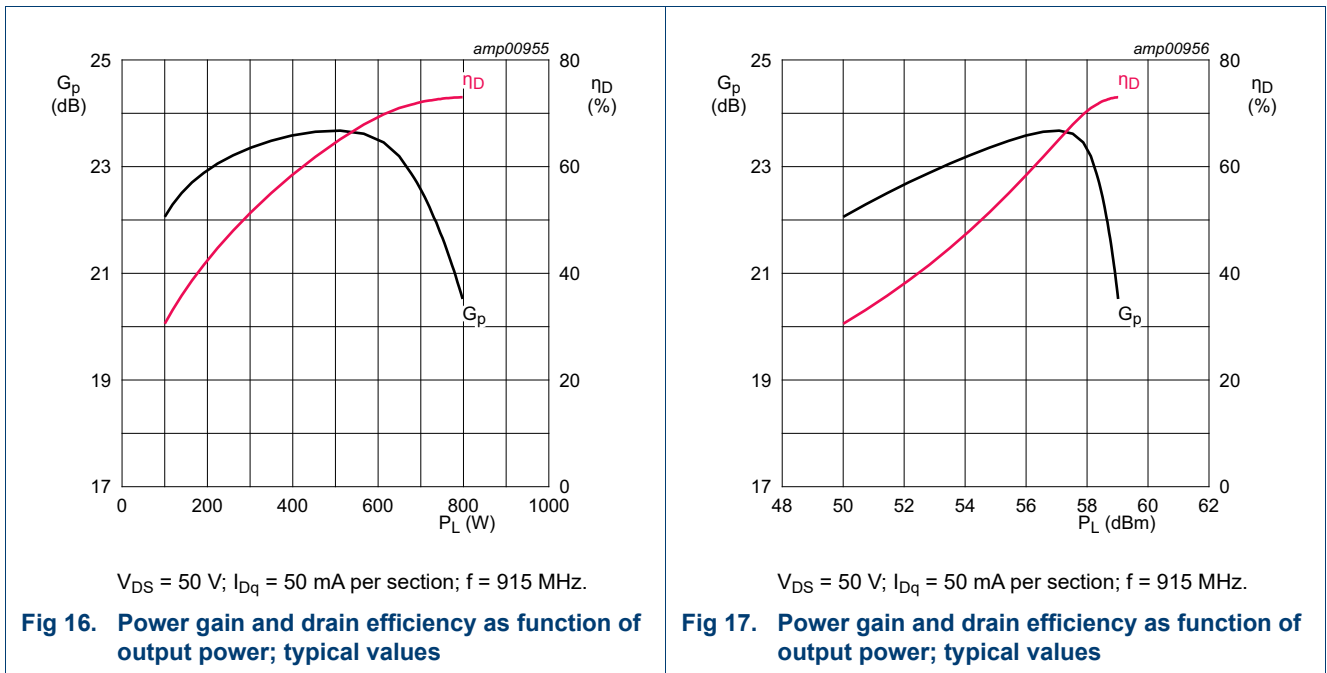

8. Package outline

Earless flanged balanced ceramic package; 4 leads

SOT539B

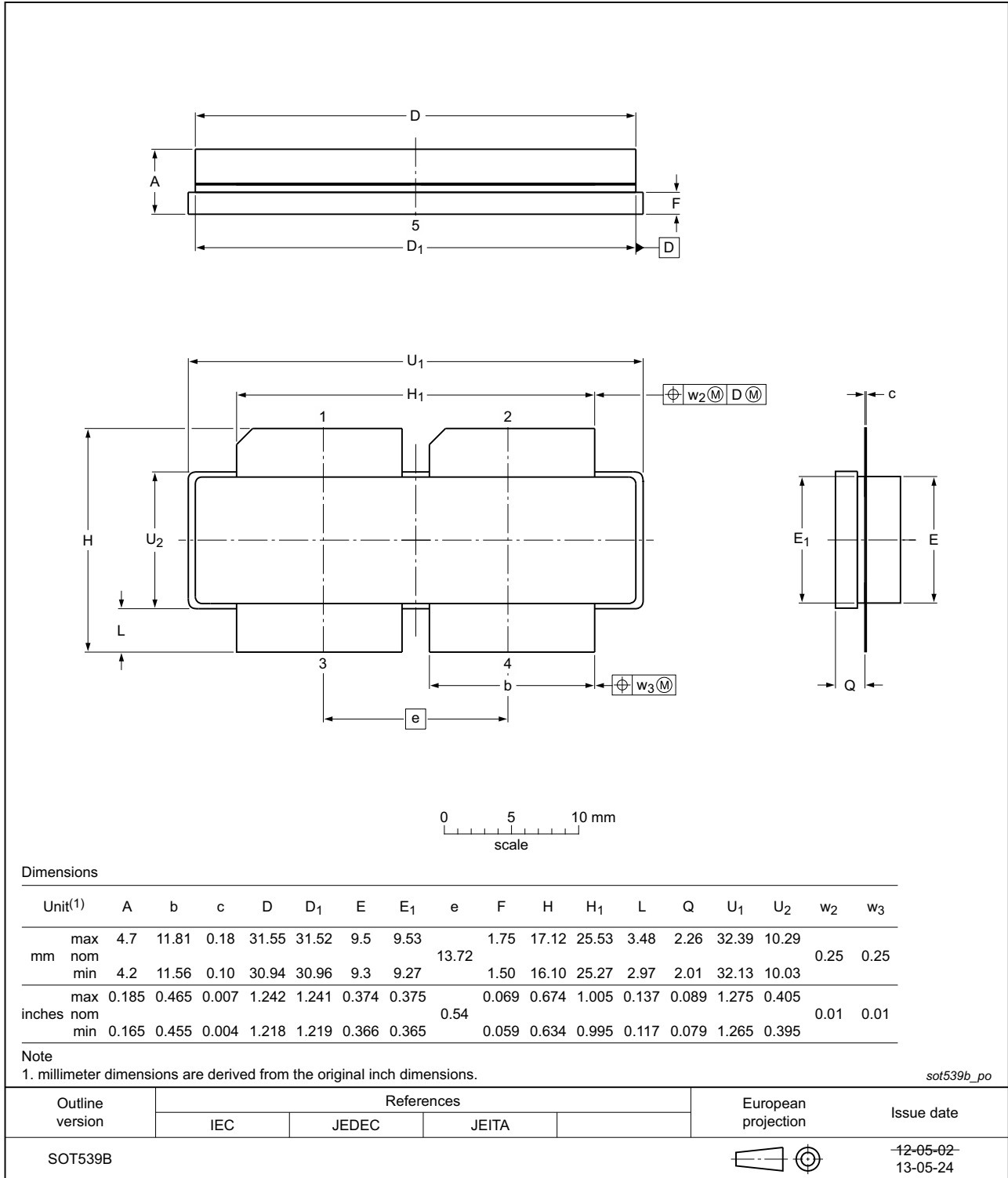

Fig 18. Package outline SOT539B

9. Handling information

CAUTION



This device is sensitive to ElectroStatic Discharge (ESD). Observe precautions for handling electrostatic sensitive devices.

Such precautions are described in the *ANSI/ESD S20.20*, *IEC/ST 61340-5*, *JESD625-A* or equivalent standards.

Table 11. ESD sensitivity

ESD model	Class
Charged Device Model (CDM); According to ANSI/ESDA/JEDEC standard JS-002	C2A [1]
Human Body Model (HBM); According to ANSI/ESDA/JEDEC standard JS-001	2 [2]

[1] CDM classification C2A is granted to any part that passes after exposure to an ESD pulse of 500 V.

[2] HBM classification 2 is granted to any part that passes after exposure to an ESD pulse of 2000 V.

10. Abbreviations

Table 12. Abbreviations

Acronym	Description
CW	Continuous Wave
ESD	ElectroStatic Discharge
ISM	Industrial, Scientific and Medical
LDMOS	Laterally Diffused Metal-Oxide Semiconductor
MTF	Median Time to Failure
RoHS	Restriction of Hazardous Substances
SMD	Surface Mounted Device
VSWR	Voltage Standing Wave Ratio

11. Revision history

Table 13. Revision history

Document ID	Release date	Data sheet status	Change notice	Supersedes
BLF0910H9LS750P v.2	20190618	Product data sheet	-	BLF0910H9LS750P v.1
Modifications:	<ul style="list-style-type: none"> Figure 1 on page 4: figure updated 			
BLF0910H9LS750P v.1	20190322	Product data sheet	-	-

12. Legal information

12.1 Data sheet status

Document status ^{[1][2]}	Product status ^[3]	Definition
Objective [short] data sheet	Development	This document contains data from the objective specification for product development.
Preliminary [short] data sheet	Qualification	This document contains data from the preliminary specification.
Product [short] data sheet	Production	This document contains the product specification.

[1] Please consult the most recently issued document before initiating or completing a design.

[2] The term 'short data sheet' is explained in section "Definitions".

[3] The product status of device(s) described in this document may have changed since this document was published and may differ in case of multiple devices. The latest product status information is available on the Internet at URL <http://www.ampleon.com>.

12.2 Definitions

Draft — The document is a draft version only. The content is still under internal review and subject to formal approval, which may result in modifications or additions. Ampleon does not give any representations or warranties as to the accuracy or completeness of information included herein and shall have no liability for the consequences of use of such information.

Short data sheet — A short data sheet is an extract from a full data sheet with the same product type number(s) and title. A short data sheet is intended for quick reference only and should not be relied upon to contain detailed and full information. For detailed and full information see the relevant full data sheet, which is available on request via the local Ampleon sales office. In case of any inconsistency or conflict with the short data sheet, the full data sheet shall prevail.

Product specification — The information and data provided in a Product data sheet shall define the specification of the product as agreed between Ampleon and its customer, unless Ampleon and customer have explicitly agreed otherwise in writing. In no event however, shall an agreement be valid in which the Ampleon product is deemed to offer functions and qualities beyond those described in the Product data sheet.

Ampleon product can reasonably be expected to result in personal injury, death or severe property or environmental damage. Ampleon and its suppliers accept no liability for inclusion and/or use of Ampleon products in such equipment or applications and therefore such inclusion and/or use is at the customer's own risk.

Applications — Applications that are described herein for any of these products are for illustrative purposes only. Ampleon makes no representation or warranty that such applications will be suitable for the specified use without further testing or modification.

Customers are responsible for the design and operation of their applications and products using Ampleon products, and Ampleon accepts no liability for any assistance with applications or customer product design. It is customer's sole responsibility to determine whether the Ampleon product is suitable and fit for the customer's applications and products planned, as well as for the planned application and use of customer's third party customer(s). Customers should provide appropriate design and operating safeguards to minimize the risks associated with their applications and products.

Ampleon does not accept any liability related to any default, damage, costs or problem which is based on any weakness or default in the customer's applications or products, or the application or use by customer's third party customer(s). Customer is responsible for doing all necessary testing for the customer's applications and products using Ampleon products in order to avoid a default of the applications and the products or of the application or use by customer's third party customer(s). Ampleon does not accept any liability in this respect.

Limiting values — Stress above one or more limiting values (as defined in the Absolute Maximum Ratings System of IEC 60134) will cause permanent damage to the device. Limiting values are stress ratings only and (proper) operation of the device at these or any other conditions above those given in the Recommended operating conditions section (if present) or the Characteristics sections of this document is not warranted. Constant or repeated exposure to limiting values will permanently and irreversibly affect the quality and reliability of the device.

Terms and conditions of commercial sale — Ampleon products are sold subject to the general terms and conditions of commercial sale, as published at <http://www.ampleon.com/terms>, unless otherwise agreed in a valid written individual agreement. In case an individual agreement is concluded only the terms and conditions of the respective agreement shall apply. Ampleon hereby expressly objects to applying the customer's general terms and conditions with regard to the purchase of Ampleon products by customer.

No offer to sell or license — Nothing in this document may be interpreted or construed as an offer to sell products that is open for acceptance or the grant, conveyance or implication of any license under any copyrights, patents or other industrial or intellectual property rights.

Export control — This document as well as the item(s) described herein may be subject to export control regulations. Export might require a prior authorization from competent authorities.

12.3 Disclaimers

Limited warranty and liability — Information in this document is believed to be accurate and reliable. However, Ampleon does not give any representations or warranties, expressed or implied, as to the accuracy or completeness of such information and shall have no liability for the consequences of use of such information. Ampleon takes no responsibility for the content in this document if provided by an information source outside of Ampleon.

In no event shall Ampleon be liable for any indirect, incidental, punitive, special or consequential damages (including - without limitation - lost profits, lost savings, business interruption, costs related to the removal or replacement of any products or rework charges) whether or not such damages are based on tort (including negligence), warranty, breach of contract or any other legal theory.

Notwithstanding any damages that customer might incur for any reason whatsoever, Ampleon's aggregate and cumulative liability towards customer for the products described herein shall be limited in accordance with the *Terms and conditions of commercial sale* of Ampleon.

Right to make changes — Ampleon reserves the right to make changes to information published in this document, including without limitation specifications and product descriptions, at any time and without notice. This document supersedes and replaces all information supplied prior to the publication hereof.

Suitability for use — Ampleon products are not designed, authorized or warranted to be suitable for use in life support, life-critical or safety-critical systems or equipment, nor in applications where failure or malfunction of an

Non-automotive qualified products — Unless this data sheet expressly states that this specific Ampleon product is automotive qualified, the product is not suitable for automotive use. It is neither qualified nor tested in accordance with automotive testing or application requirements. Ampleon accepts no liability for inclusion and/or use of non-automotive qualified products in automotive equipment or applications.

In the event that customer uses the product for design-in and use in automotive applications to automotive specifications and standards, customer (a) shall use the product without Ampleon's warranty of the product for such automotive applications, use and specifications, and (b) whenever customer uses the product for automotive applications beyond Ampleon's specifications such use shall be solely at customer's own risk, and (c) customer fully indemnifies Ampleon for any liability, damages or failed product claims resulting from customer design and use of the product for automotive applications beyond Ampleon's standard warranty and Ampleon's product specifications.

Translations — A non-English (translated) version of a document is for reference only. The English version shall prevail in case of any discrepancy between the translated and English versions.

12.4 Trademarks

Notice: All referenced brands, product names, service names and trademarks are the property of their respective owners.

Any reference or use of any 'NXP' trademark in this document or in or on the surface of Ampleon products does not result in any claim, liability or entitlement vis-à-vis the owner of this trademark. Ampleon is no longer part of the NXP group of companies and any reference to or use of the 'NXP' trademarks will be replaced by reference to or use of Ampleon's own trademarks.

13. Contact information

For more information, please visit: <http://www.ampleon.com>

For sales office addresses, please visit: <http://www.ampleon.com/sales>

14. Contents

1	Product profile	1
1.1	General description	1
1.2	Features and benefits	1
1.3	Applications	1
2	Pinning information	2
3	Ordering information	2
4	Limiting values	2
5	Thermal characteristics	2
6	Characteristics	3
7	Test information	3
7.1	Ruggedness in class-AB operation	3
7.2	Impedance information	3
7.3	Test circuit broadband	4
7.4	Graphical data broadband circuit	5
7.4.1	CW	5
7.5	Test circuit narrowband	8
7.6	Graphical data narrowband circuit	9
7.6.1	CW	9
8	Package outline	10
9	Handling information	11
10	Abbreviations	11
11	Revision history	11
12	Legal information	12
12.1	Data sheet status	12
12.2	Definitions	12
12.3	Disclaimers	12
12.4	Trademarks	13
13	Contact information	13
14	Contents	14

Please be aware that important notices concerning this document and the product(s) described herein, have been included in section 'Legal information'.

© Ampleon Netherlands B.V. 2019. All rights reserved.

For more information, please visit: <http://www.ampleon.com>
 For sales office addresses, please visit: <http://www.ampleon.com/sales>

Date of release: 18 June 2019

Document identifier: BLF0910H9LS750P