

KQWS SERIES

40W WIDE INPUT RANGE

DANUBE

FEATURES

- 40W DIL PACKAGE
- INDUSTRY STANDARD PACKAGE
- 9-18V,18-36V,36-75V,9-36V,18-75V WIDE INPUT RANGE
- 100% BURNED IN
- HIGH EFFICIENCY
- UL 94V-0 PACKAGE MATERIAL
- CUSTOM SOLUTIONS AVAILABLE
- 3 YEARS WARRANTY



OUTPUT SPECIFICATIONS

Voltage Setpoint Accuracy	+/-2% max.
Over Voltage Protection	Built-in
Temperature Coefficient	+/-0.03%/°C
Ripple & Noise(20MHz BW) ¹	100mVp-p max.
Line Regulation ²	+/-0.5% max.
Load Regulation ³	+/-0.5% max.
Minimum load	10% of Full Load
Short Circuit Protection	Continuous
Short Circuit Restart	Automatic
External Trim Adj. Range	+/-10%
Over Load Protection	150% typ.
Transient Response ⁵	500uS max.

INPUT SPECIFICATIONS

Input Voltage Range	2:1 or 4:1 Input Range
Input Filter	Pi Network
Protection	Fuse Recommended
Start up time(Nominal input)	10ms max.

GENERAL SPECIFICATIONS

Efficiency	90% typ.
Isolation Voltage (Input / Output / case)	1500 VDC min.
Isolation Voltage ⁴	1500 VDC min.
Isolation Resistance	10 ⁹ ohms min.
Isolation Capacitance	2500pF max.
Switching Frequency	250KHz typ.
Weight	50g typ.
Case Material	Six-Side Shielded Case
Case Size	50.8mm*50.8mm*11mm
Potting Material	Epoxy(UL94-V0)
Conducted Emissions	EN55022 Class A
Radiated Emissions	EN55022 Class A

ENVIRONMENTAL SPECIFICATIONS

Operating Temperature	
No Heat Sink	-40 °C to +60 °C
With Heat Sink	-40 °C to +75 °C
Case Temperature	+100 °C max.
Storage Temperature	-55 °C to +100 °C
Humidity	95% max.
Cooling	Free-Air Convection

ALL SPECIFICATIONS TYPICAL AT NOMINAL LINE, FULL LOAD , AND 25 °C UNLESS OTHERWISE NOTED.

¹ Measured with 1uF ceramic capacitor connect to the output pins.

² High Line to Low Line.

³ Load Regulation is for output load current change from 10% to 100%.

⁴ For 10 seconds.

⁵ 50% Step Load Change.

● **SELECTION GUIDE(1)**
2:1 33W~40W OUTPUT

MODEL NUMBER	INPUT VOLTAGE (VDC)	OUTPUT VOLTAGE (VDC)	OUTPUT CURRENT (mA)	INPUT ⁶ CURRENT(mA)		EFF (%) ⁷	CAPACITOR LOAD (Max)
				FULL LOAD	NO LOAD		
KQWS-1203.3(HS)	9-18	3.3	10000	3125	150	88	4700uF
KQWS-1205(HS)	9-18	5	8000	3663	150	91	4700uF
KQWS-1209(HS)	9-18	9	4444	3663	150	91	3300uF
KQWS-1212(HS)	9-18	12	3333	3703	150	90	1500uF
KQWS-1215(HS)	9-18	15	2667	3703	150	90	820uF
KQWS-2403.3(HS)	18-36	3.3	10000	1545	100	89	4700uF
KQWS-2405(HS)	18-36	5	8000	1785	100	93	4700uF
KQWS-2409(HS)	18-36	9	4444	1832	100	91	3300uF
KQWS-2412(HS)	18-36	12	3333	1832	100	91	1500uF
KQWS-2415(HS)	18-36	15	2667	1825	100	91	820uF
KQWS-4803.3(HS)	36-75	3.3	10000	764	40	90	4700uF
KQWS-4805(HS)	36-75	5	8000	906	40	92	4700uF
KQWS-4809(HS)	36-75	9	4444	916	40	91	3300uF
KQWS-4812(HS)	36-75	12	3333	920	40	91	1500uF
KQWS-4815(HS)	36-75	15	2667	920	40	91	820uF

Note: Other input to output voltages may be available. Please contact factory.

⁶ NOMINAL INPUT VOLTAGE.

⁷ NOMINAL INPUT VOLTAGE, FULL LOAD.

● **SELECTION GUIDE(2)**
4:1 33W~40W OUTPUT

MODEL NUMBER	INPUT VOLTAGE (VDC)	OUTPUT VOLTAGE (VDC)	OUTPUT CURRENT (mA)	INPUT ⁸ CURRENT(mA)		EFF (%) ⁹	CAPACITOR LOAD (Max)
				FULL LOAD	NO LOAD		
KQWS-1203.3T(HS)	9-36	3.3	10000	3161	150	87	4700uF
KQWS-1205T(HS)	9-36	5	8000	3745	150	89	4700uF
KQWS-1209T(HS)	9-36	9	4444	3745	150	89	3300uF
KQWS-1212T(HS)	9-36	12	3333	3704	150	90	950uF
KQWS-1215T(HS)	9-36	15	2667	3704	150	90	820uF
KQWS-2403.3T(HS)	18-75	3.3	10000	1580	100	87	4700uF
KQWS-2405T(HS)	18-75	5	8000	1873	100	89	4700uF
KQWS-2409T(HS)	18-75	9	4444	1873	100	89	3300uF
KQWS-2412T(HS)	18-75	12	3333	1894	100	88	950uF
KQWS-2415T(HS)	18-75	15	2667	1852	100	90	820uF

Note: Other input to output voltages may be available. Please contact factory.

● **PART NUMBERS STRUCTURE**

Model Name	Difference
KQWv-x1x2T(HSJ)	<p>KQ=Series Name W=Wide Input Range v=Type of output voltage (S=single output) x1=Input voltage(9~18V ; 18~36V ; 36~75V ; 9~36V ; 18-75V) x2=Output voltage(03.3 ; 05 ; 09 ; 12 ; 15) T= Input Range 4:1 HS=With Heat Sink zzz= 0~9 , A~Z or blank for market purpose. J=Pin Length 3.5 mm</p>

⁸ NOMINAL INPUT VOLTAGE.

⁹ NOMINAL INPUT VOLTAGE, FULL LOAD.

● SIMPLIFIED SCHEMATIC

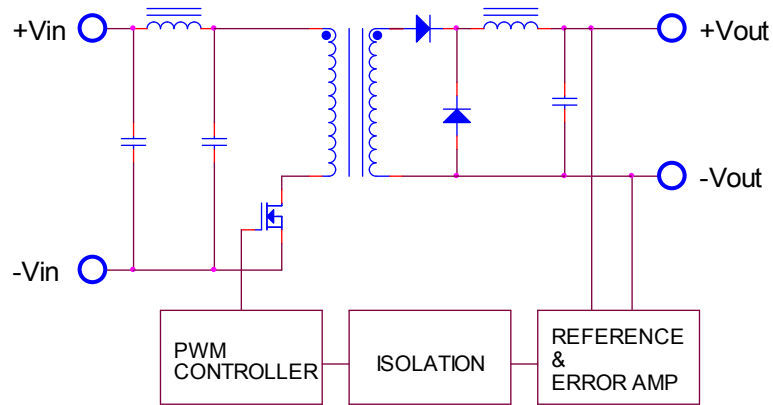

● MECHANICAL DIMENSIONS

No Heat-sink

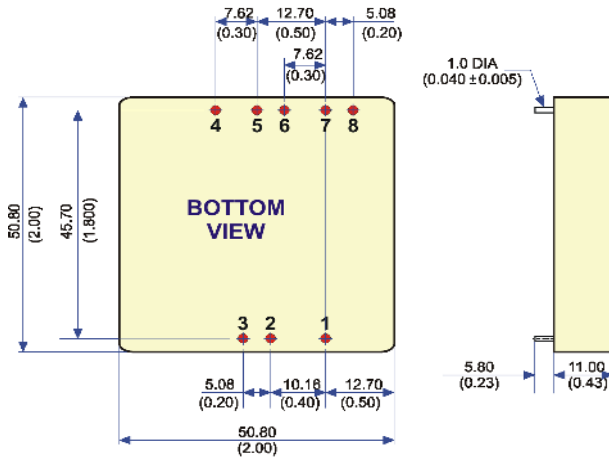

PIN	SINGLE
1	Remote On/Off
2	-Vin
3	+Vin
4	-Sense
5	+Sense
6	+Vout
7	-Vout
8	Trim

NOTE: Pin Size is Tolerance 1.0Φ ±0.10mm

All Dimensions In mm(Inches)

Tolerance .X or .XX= ±0.5mm

With Heat-sink

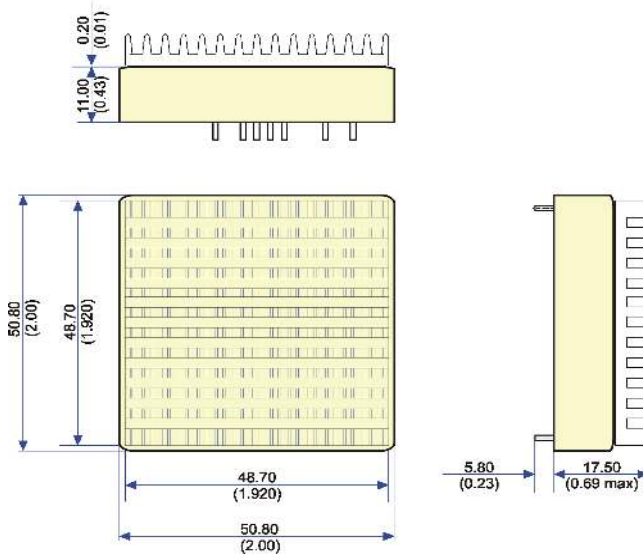

All dimensions are in mm [inches]

Remote On/Off Control			
Control Input	PIN1	Control Common	PIN2
Control Voltage		Converter Shutdown Idle Current	10mA
ON	>+2.5VDC or Open Circuit	Logic Compatibility	CMOS or Open
OFF	<+0.5VDC or Jumper to PIN2		Collector TTL

● TYPICAL APPLICATIONS

FIXED VOLTAGE OUTPUT

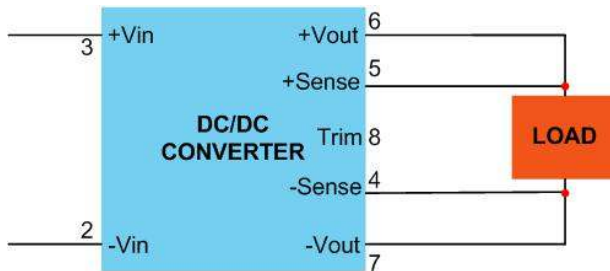

TRIM CONNECTIONS USING A TRIMPOT

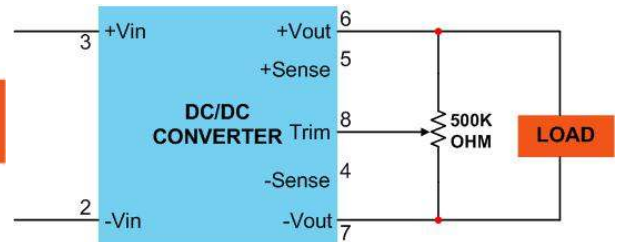

FIXED-VALUE TRIM DOWN RESISTOR

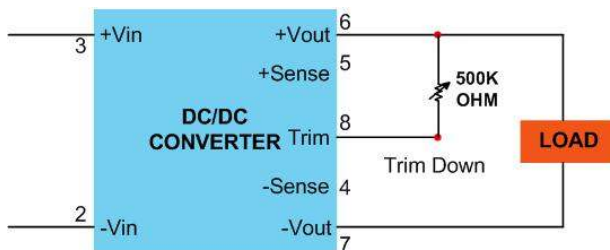

FIXED-VALUE TRIM UP RESISTOR

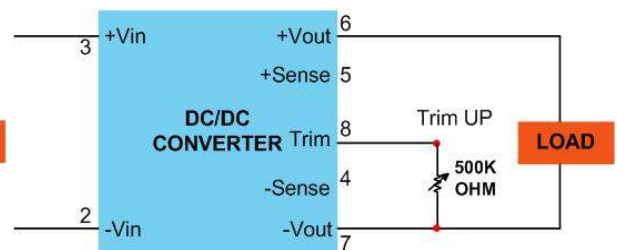

● RECOMMENDED FOOTPRINT DETAILS

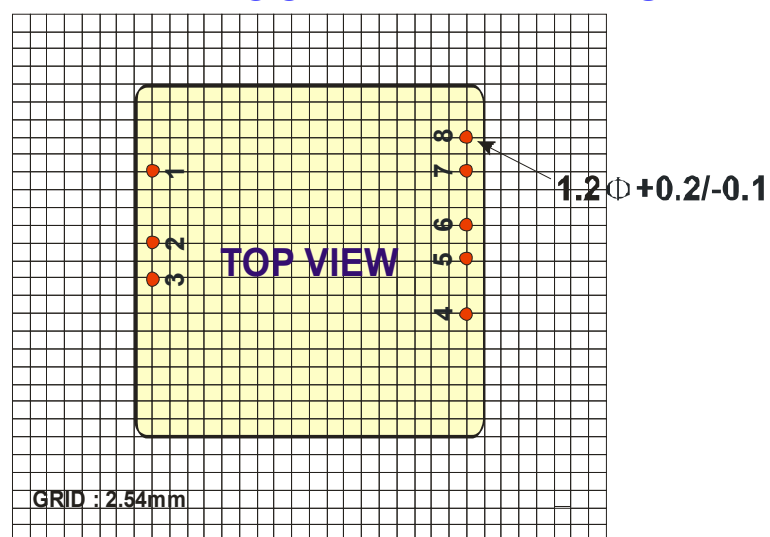

● TYPICAL PERFORMANCE CURVES

Specifications typical at $T_a=25^{\circ}\text{C}$, nominal input voltage, rated output current unless otherwise specified.

OUTPUT LOAD VS EFFICIENCY

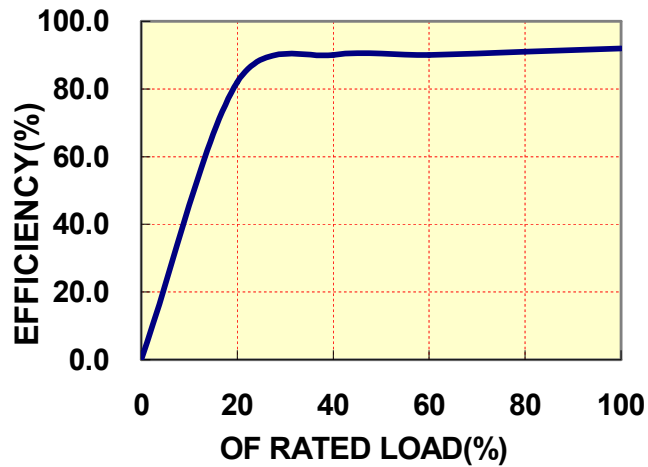

TEMPERATURE DERATING

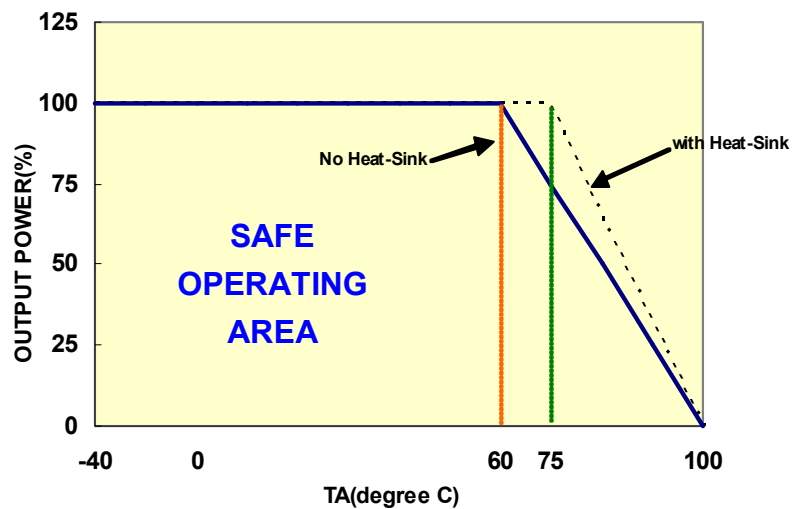

● INPUT FUSE SELECTION GUIDE

9-18V or 9-36V INPUT VOLTAGE(VDC)	18-36V or 18-75V INPUT VOLTAGE(VDC)	36-75V INPUT VOLTAGE(VDC)
10000mA Slow-Blow Type	6000mA Slow-Blow Type	3000mA Slow-Blow Type

Note: Certain applications may require the installation of external fuse in front of the input.

KQWS SERIES APPLICATION NOTES:

EXTERNAL CAPACITANCE REQUIREMENTS:

External output capacitance is not required for operation, however it is recommended that 10uF MLCC and 0.1uF ceramic capacitance be selected for reduced system noise.

Additional output capacitance may be added for increased filtering, but should not exceed 1000uF.

Negative Outputs:

A negative output voltage may be obtained by connecting the +OUT to circuit ground and connecting -OUT as the negative output.

Remote ON/OFF:

The remote ON/OFF pin may be left floating if this function is not use. It is recommended to drive this pin with an open collector arrangement or a relay contact. When the ON/OFF pin is pulled low with respect to the -Vin , the converter is placed in a low power drain state.

Output TRIM:

The TRIM pin may be used to adjust the output +/-10% from the nominal setting .this function allows adjustment for voltage drops in the system wiring. If the TRIM function is not required the pin may be left floating.

FOR MORE INFORMATION CALL:

Danube Enterprise Co., Ltd.

Tel: 886-7-3755165

Fax: 886-7-3755330

E-mail: danube@ms10.hinet.net

Home Page

<http://www.danube.com.tw>
