

Very High Slew Rate Wideband Operational Amplifier

March 1993

Features

- Very High Slew Rate.....600V/ μ s
- Open Loop Gain.....15kV/V
- Wide Gain-Bandwidth ($A_v \geq 10$).....600MHz
- Power Bandwidth.....9.5MHz
- Low Offset Voltage.....8mV
- Input Voltage Noise.....6nV/ $\sqrt{\text{Hz}}$
- Output Voltage Swing..... $\pm 10\text{V}$
- Monolithic Bipolar Dielectric Construction

Applications

- Pulse and Video Amplifiers
- Wideband Amplifiers
- High Speed Sample-Hold Circuits
- RF Oscillators

Ordering Information

PART NUMBER	TEMP. RANGE	PACKAGE
HA1-2539-2	-55°C to +125°C	14 Lead Ceramic DIP
HA1-2539-5	0°C to +75°C	14 Lead Ceramic DIP
HA1-2539-9	-40°C to +85°C	14 Lead Ceramic DIP
HA1-2539C-5	0°C to +75°C	14 Lead Ceramic DIP
HA1-2539C-9	-40°C to +85°C	14 Lead Ceramic DIP
HA3-2539-5	0°C to +75°C	14 Lead Plastic DIP
HA3-2539-9	-40°C to +85°C	14 Lead Plastic DIP
HA3-2539C-5	0°C to +75°C	14 Lead Plastic DIP
HA4P2539-5	0°C to +75°C	20 Lead PLCC
HA9P2539-5	0°C to +75°C	14 Lead SOIC
HA9P2539-9	-40°C to +85°C	14 Lead SOIC
HA9P2539C-5	0°C to +75°C	14 Lead SOIC
HA9P2539C-9	-40°C to +85°C	14 Lead SOIC

Description

The Harris HA-2539 represents the ultimate in high slew rate, wideband, monolithic operational amplifiers. It has been designed and constructed with the Harris High Frequency Bipolar Dielectric Isolation process and features dynamic parameters never before available from a truly differential device.

With a 600V/ms slew rate and a 600MHz gain bandwidth product, the HA-2539 is ideally suited for use in video and RF amplifier designs, in closed loop gains of 10 or greater. Full $\pm 10\text{V}$ swing coupled with outstanding AC parameters and complemented by high open loop gain makes the devices useful in high speed data acquisition systems.

For further design assistance please refer to Application Note 541 (Using the HA-2539 Very High Slew Rate Wideband Operational Amplifiers) and Application Note 556 (Thermal Safe-Operating-Areas For High Current Operational Amplifiers).

For military grade product information, the HA-2539/883 data sheet is available upon request.

For a lower power version of this product, please see the HA-2839 and HA-2840 data sheets.

Pinouts

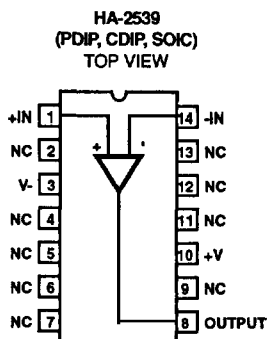

(NC) No Connection pins may be tied to a ground plane for better isolation and heat dissipation.

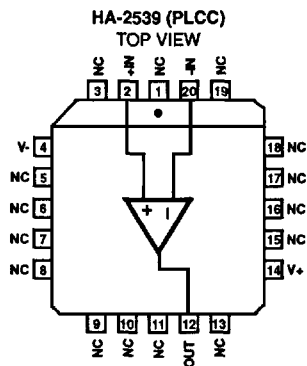

CAUTION: These devices are sensitive to electrostatic discharge. Users should follow proper I.C. Handling Procedures.
Copyright © Harris Corporation 1993

2-315

File Number 2896.1

Specifications HA-2539

Absolute Maximum Ratings (Note 1)

Supply Voltage Between V+ and V- Terminals	35V
Differential Input Voltage	6V
Peak Output Current	50mA
Continuous Output Current	33mA _{max}
Internal Quiescent Power Dissipation (Note 2)	
Junction Temperature	+175°C
Junction Temperature (Plastic Package)	+150°C
Lead Temperature (Soldering 10 Sec.)	+300°C

Operating Conditions

Operating Temperature Range	
HA-2539-2	-55°C ≤ T _A ≤ +125°C
HA-2539/2539C-5	0°C ≤ T _A ≤ +75°C
HA-2539-9	-40°C ≤ T _A ≤ +85°C
Storage Temperature Range	-65°C ≤ T _A ≤ +150°C

CAUTION: Stresses above those listed in "Absolute Maximum Ratings" may cause permanent damage to the device. This is a stress only rating and operation of the device at these or any other conditions above those indicated in the operational sections of this specification is not implied.

Electrical Specifications $V_{SUPPLY} = \pm 15V, R_L = 1k\Omega, C_L < 10pF$, Unless Otherwise Specified.

PARAMETER	TEMP	HA-2539-2 LIMITS			HA-2539-5, -9 LIMITS			HA-2539C-5, -9 LIMITS			UNITS
		MIN	TYP	MAX	MIN	TYP	MAX	MIN	TYP	MAX	
INPUT CHARACTERISTICS											
Offset Voltage	+25°C	-	8	10	-	8	15	-	8	15	mV
	Full	-	13	15	-	13	20	-	13	20	mV
Average Offset Voltage Drift	Full	-	20	-	-	20	-	-	20	-	μV/°C
Bias Current	+25°C	-	5	20	-	5	20	-	5	20	μA
	Full	-	-	25	-	-	25	-	-	25	μA
Offset Current	+25°C	-	1	6	-	1	6	-	1	6	μA
	Full	-	-	8	-	-	8	-	-	8	μA
Input Resistance	+25°C	-	10	-	-	10	-	-	10	-	kΩ
Input Capacitance	+25°C	-	1	-	-	1	-	-	1	-	pF
Common Mode Range	Full	±10.0	-	-	±10.0	-	-	±10.0	-	-	V
Input Current Noise (f = 1kHz, R _{SOURCE} = 0Ω)	+25°C	-	6	-	-	6	-	-	6	-	pA/√Hz
Input Voltage Noise (f = 1kHz, R _{SOURCE} = 0Ω)	+25°C	-	6	-	-	6	-	-	6	-	nV/√Hz
TRANSFER CHARACTERISTICS											
Large Signal Voltage Gain (Notes 3)	+25°C	10	15	-	10	15	-	7	10	-	kV/V
	Full	5	-	-	5	-	-	5	-	-	kV/V
Common Mode Rejection Ratio (Note 4)	Full	60	72	-	60	72	-	60	72	-	dB
Minimum Stable Gain	+25°C	10	-	-	10	-	-	10	-	-	V/V
Gain Bandwidth (Notes 5, 6)	+25°C	-	600	-	-	600	0	0	600	-	MHz
OUTPUT CHARACTERISTICS											
Output Voltage Swing (Note 3, 10)	Full	±10.0	-	-	±10.0	-	-	±10.0	-	-	V
Output Current (Note 3)	+25°C	±10	±20	-	±10	±20	-	±10	±20	-	mA
Output Resistance	+25°C	-	30	-	-	30	-	-	30	-	Ω
Full Power Bandwidth (Notes 3, 7)	+25°C	8.7	9.5	-	8.7	9.5	-	8.7	9.5	-	MHz
TRANSIENT RESPONSE (Note 8)											
Rise Time	+25°C	-	7	-	-	7	-	-	7	-	ns
Overshoot	+25°C	-	15	-	-	15	-	-	15	-	%
Slew Rate	+25°C	550	600	-	550	600	-	550	600	-	V/μs
Settling Time: 10V Step to 0.1%	+25°C	-	180	-	-	180	-	-	200	-	ns
POWER REQUIREMENTS											

Specifications HA-2539

Electrical Specifications $V_{SUPPLY} = \pm 15V$, $R_L = 1k\Omega$, $C_L < 10pF$, Unless Otherwise Specified. (Continued)

PARAMETER	TEMP	HA-2539-2 LIMITS			HA-2539-5, -9 LIMITS			HA-2539C-5, -9 LIMITS			UNITS
		MIN	TYP	MAX	MIN	TYP	MAX	MIN	TYP	MAX	
Supply Current	Full	-	20	25	-	20	25	-	20	25	mA
Power Supply Rejection Ratio (Note 9)	Full	60	70	-	60	70	-	60	70	-	dB

NOTES:

- Absolute maximum ratings are limiting values, applied individually, beyond which the serviceability of the circuit may be impaired. Functional operation under any of these conditions is not necessarily implied.
- Maximum power dissipation with load conditions must be designed to maintain the maximum junction temperature below +175°C for the ceramic package and below +150°C for the plastic packages. By using Application Note 556 on Safe Operating Area equations, along with the packaging thermal resistances listed in the Die Characteristics section, proper load conditions can be determined. Heat sinking is recommended above +75°C with suggested models:
Thermalloy #6007 ($\theta_{SA} = 40^\circ C/W$) or AAVID #5602B ($\theta_{SA} = 16^\circ C/W$).
- $R_L = 1k\Omega$, $V_O = \pm 10V$
- $V_{CM} = \pm 10.0V$
- $V_O = 90mV$
- $A_V = 10$
- Full Power Bandwidth guaranteed based on slew rate measurement using $FPBW = \frac{\text{Slew Rate}}{2\pi V_{PEAK}}$
- Refer to Test Circuits section of data sheet.
- $V_{SUPPLY} = +5V, -15V$ and $+15V, -5V$
- Guaranteed range for output voltage is $\pm 10V$. Functional operation outside of this range is not guaranteed.

Schematic Diagram

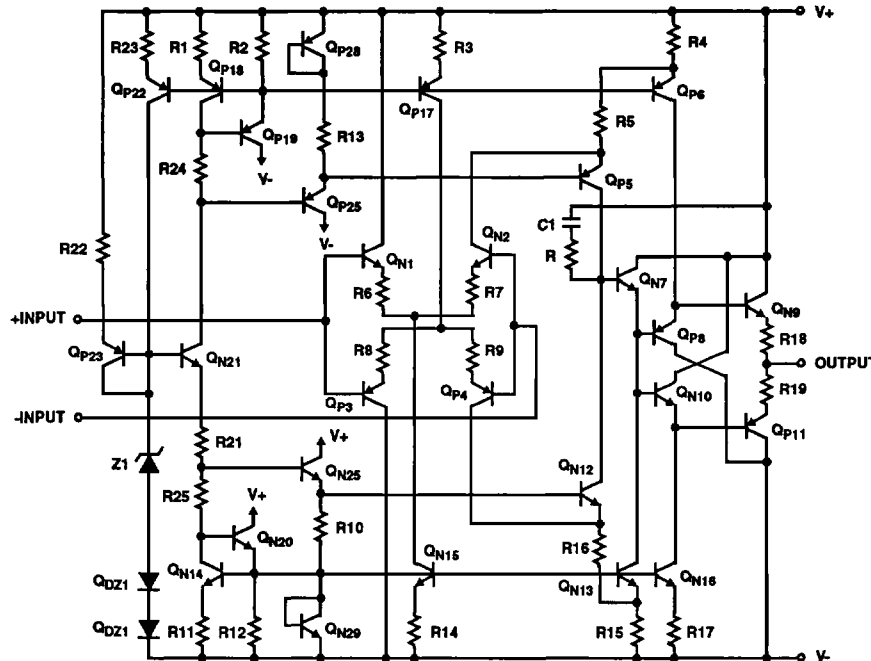

Die Characteristics

Transistor Count	30	Thermal Constants (°C/W)	θ_{JA}	θ_{JC}
Die Dimensions	75 x 61 x 19 mils (1910 μ m x 1550 μ m x 483 μ m)	Ceramic DIP	71	14
Substrate Potential (Power Up)*	V-	Plastic DIP	107	38
Process	High Frequency Bipolar-DI	SOIC	119	36
Passivation	Nitride	PLCC	74	33

* The substrate may be left floating (Insulating Die Mount) or it may be mounted on conductor at V- potential.

Test Circuits

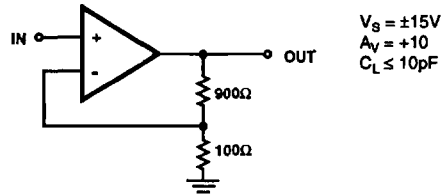

FIGURE 1. TEST CIRCUIT

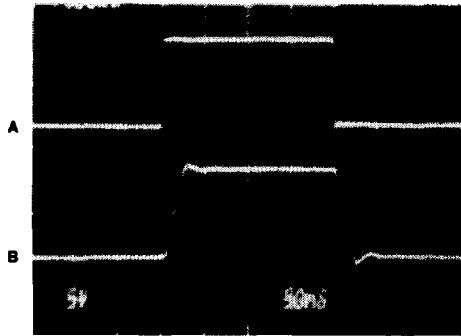

FIGURE 2. LARGE SIGNAL RESPONSE
Vertical Scale: A = 0.5V/Div., B = 5.0V/Div.
Horizontal Scale: Time: 50ns/Div.

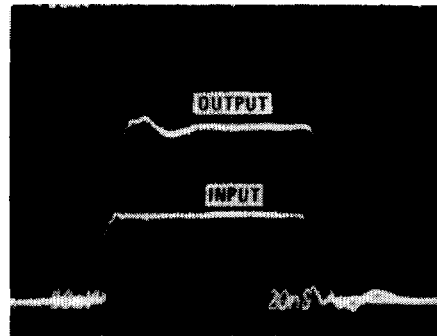

FIGURE 3. SMALL SIGNAL RESPONSE
Vertical Scale: Input = 10mV/Div., Output = 50mV/Div.
Horizontal Scale: 20ns/Div.

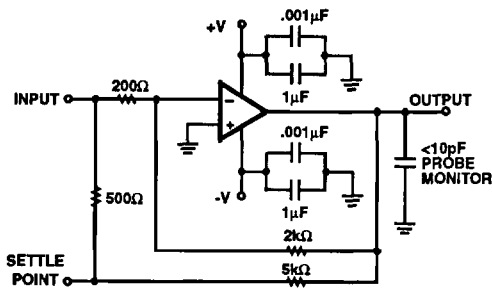

FIGURE 4. SETTLING TIME CIRCUIT

- $A_V = -10$
- Load Capacitance should be less than 10pF.
- It is recommended that resistors be carbon composition and that feedback and summing network ratios be matched to 0.1%.
- SETTLE POINT (Summing Node) capacitance should be less than 10pF. For optimum settling time results, it is recommended that the test circuit be constructed directly onto the device pins. A Tektronix 568 Sampling Oscilloscope with S-3A sampling heads is recommended as a settle point monitor.

Typical Performance Curves

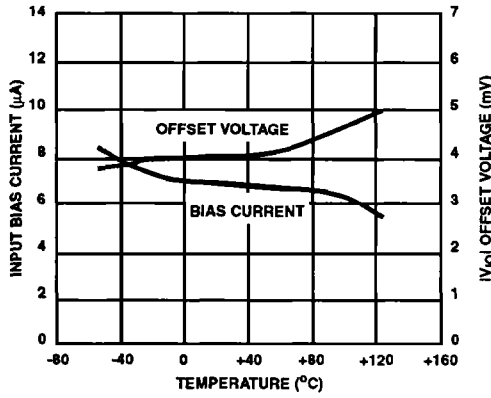

FIGURE 5. INPUT OFFSET VOLTAGE AND BIAS CURRENT vs TEMPERATURE

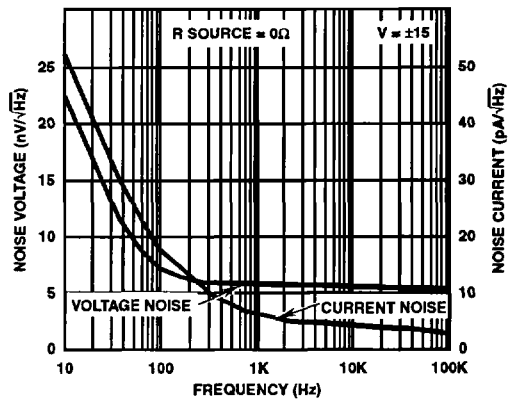

FIGURE 6. INPUT NOISE VOLTAGE AND NOISE CURRENT vs FREQUENCY

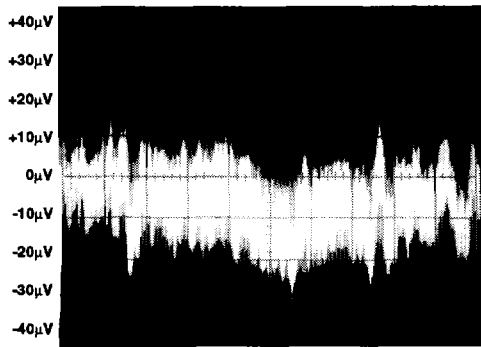

FIGURE 7. BROADBAND NOISE (0.1HZ TO 1MHZ)
Vertical Scale: 10mV/Div.
Horizontal Scale: 50ms/Div.

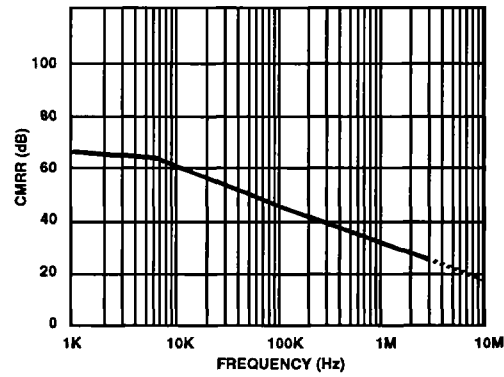

FIGURE 8. COMMON MODE REJECTION RATIO vs FREQUENCY

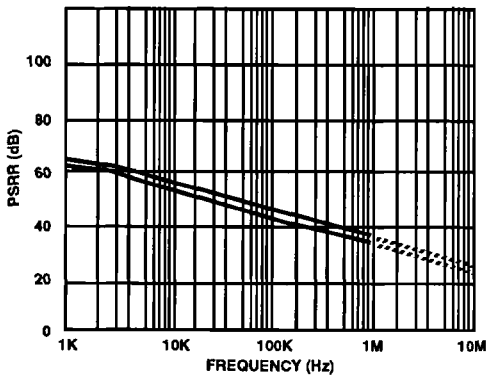

FIGURE 9. POWER SUPPLY REJECTION RATIO vs FREQUENCY

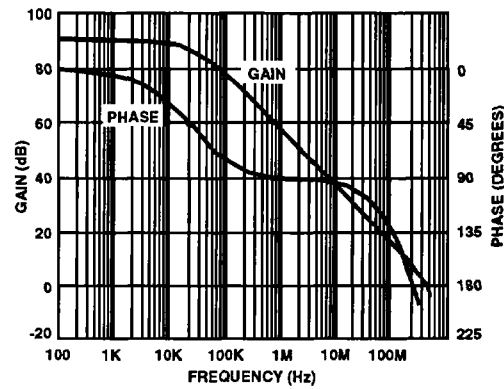

FIGURE 10. OPEN LOOP GAIN/PHASE vs FREQUENCY

Typical Performance Curves (Continued)

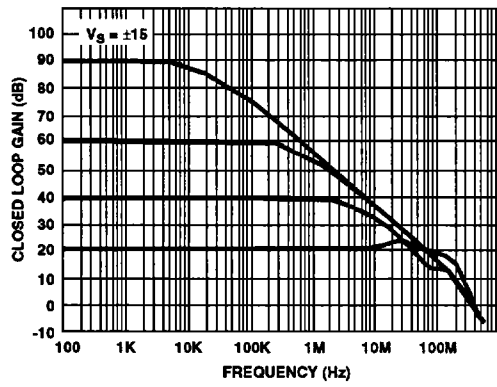

FIGURE 11. CLOSED LOOP FREQUENCY RESPONSE FOR VARIOUS CLOSED LOOP GAINS

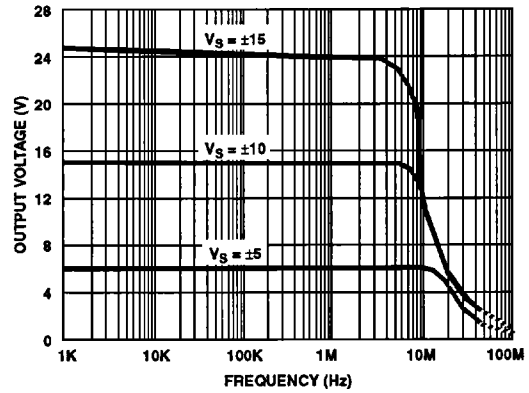

FIGURE 12. OUTPUT VOLTAGE SWING vs FREQUENCY

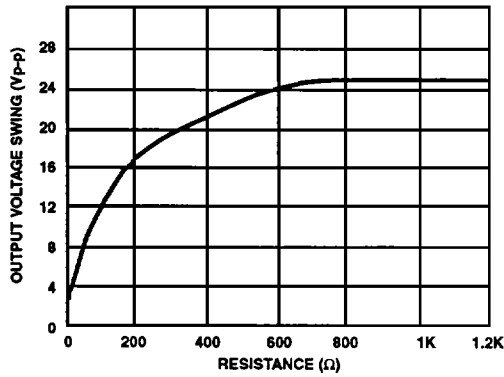

FIGURE 13. OUTPUT VOLTAGE SWING vs LOAD RESISTANCE

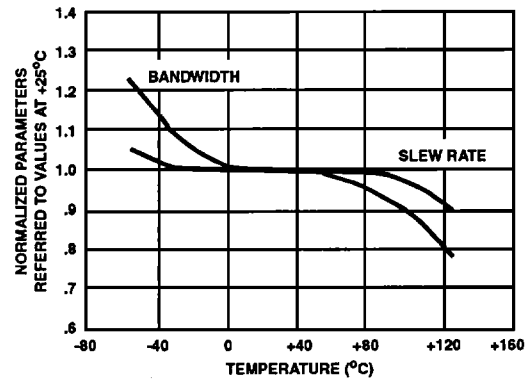

FIGURE 14. NORMALIZED AC PARAMETERS vs TEMPERATURE

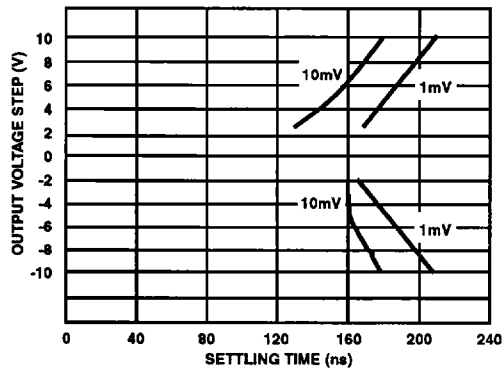

FIGURE 15. SETTLING TIME FOR VARIOUS OUTPUT STEP VOLTAGES

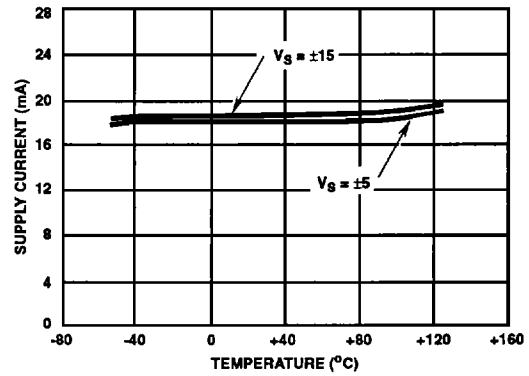

FIGURE 16. POWER SUPPLY CURRENT vs TEMPERATURE AND SUPPLY VOLTAGE

Typical Applications

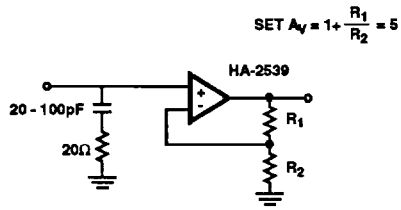

FIGURE 17. FREQUENCY COMPENSATION BY OVERDAMPING

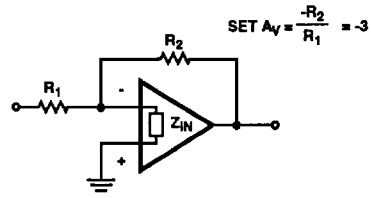

FIGURE 18. STABILIZATION USING Z_{IN}

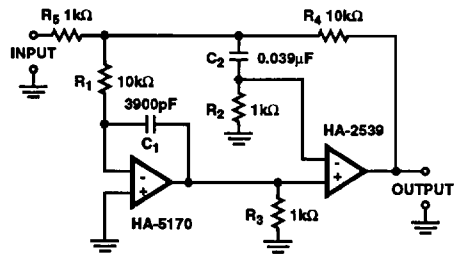

FIGURE 19. REDUCING DC ERRORS; COMPOSITE AMPLIFIER

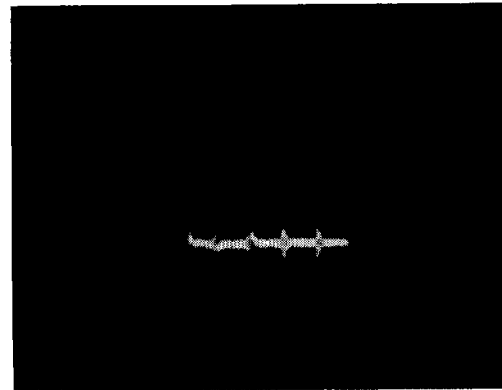

FIGURE 20. DIFFERENTIAL GAIN ERROR (3%) HA-2539 20dB VIDEO GAIN BLOCK