



User Guide

UG000400

AS7341 11-Channel Spectral Sensor

Evaluation Kit v1

AS7341 EVAL KIT

v2-00 • 2018-Oct-30

Content Guide

1	Introduction.....	3	5.1	Software Installation.....	12
1.1	Kit Content.....	3	5.2	AS7341 EVM Graphical User Interface	13
1.2	Ordering Information	4	5.3	Sensor Board Test	13
2	Getting Started.....	5	5.4	Tab File	14
3	Hardware Description.....	6	5.5	Tab Log	15
3.1	Hardware Architecture	6	5.6	Menu Flicker Log	15
3.2	Power Supply	7	5.7	Main Page	15
3.3	Connector Pinout Description	7	5.8	Register Mapping	18
3.4	Schematic Drawing	9	5.9	Tracer.....	19
4	Optical Diffuser.....	11	6	Revision Information.....	22
5	Software	12	7	Legal Information	23

1 Introduction

AS7341 Eval Kit is a platform to evaluate ams AS7341 11-channel spectral sensor. This user guide describes the features and functions of Windows 10 based Evaluation Kit with GUI.

1.1 Kit Content

The AS7341 Evaluation Kit exists from following items.

Figure 1 :
Kit Content

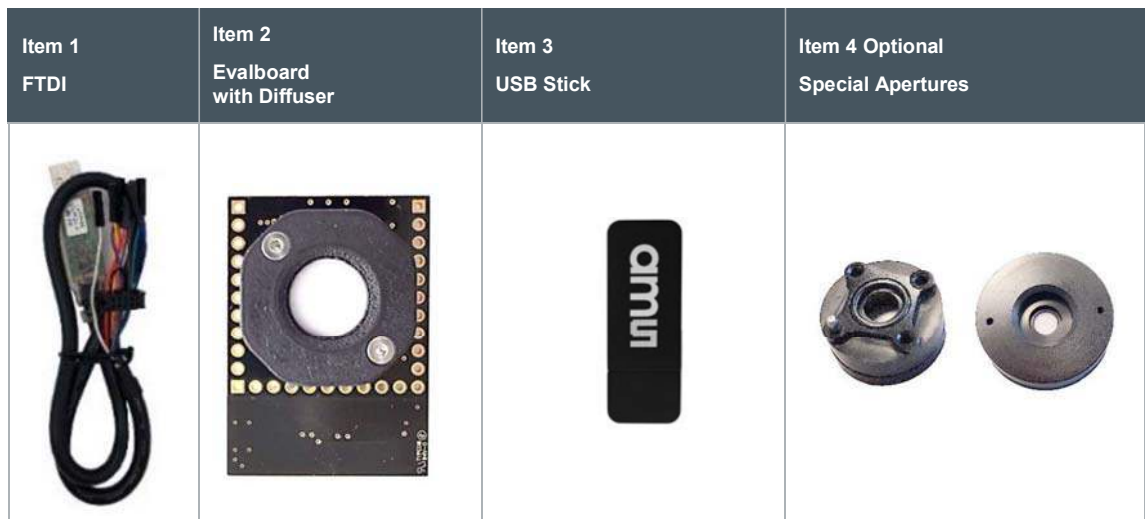

Item No.:	Item	Comment
1	FTDI - USB Cable	USB – I ² C Cable with 10 pol IDC Connector, Variant 3.3V
2	a0013a0_CSS Evalboard AS7341	Evaluation board with pre-mounted adapter and diffuser
3	USB Data Stick	Documents, software, firmware and drivers
4	Special Apertures e.g. Diff 25	Optional: CSS 25 mm adapter for LINOS – must be ordered separately

1.2 Ordering Information

Ordering Code	Description
AS7341 EVAL KIT	AS7341 11-Channel Spectral Sensor Evaluation Kit v1
Aperture Diff 25	CSS 25 mm Adapter plus Diffuser for Evaluation Kit

2 Getting Started

The Evaluation Kit exists from the FTDI USB cable and the Evaluation board with pre-mounted adapter for diffuser, which is necessary to fulfil the optical requirements of the AS7341 filter specification.

The Evaluation board has an I²C interface, which will be converted to UART with USB interface by the FTDI cable.

Figure 2:
AS7341 Eval Kit with Sensor and Evaluation Board and Pre-Mounted Diffuser



Plug the FTDI cable into the socket of the Evaluation board and connect the kit via USB to PC.

The Evaluation Kit requires a onetime installation of FTDI Virtual COM Port Driver for the USB cable. The installation files for the FTDI adapter were on the USB Data Stick in the setup directories. Please install it as an administrator.

If there is an issue about the installation, please read our AS7341 Quick_Start_Guide on USB stick or refer to www.ftdichip.com for more information.

Install the AS7341 Software from the AS7341_Software.msi on the USB Data Stick.

Please see chapter 5 for the software handling and description.

3 Hardware Description

The Evaluation Kit was designed to work as an attachment board for a 1/10inch hole-grid-plate, or it is mounted with an adapter to an optical bench. Adapters for 25mm systems are available as accessories from **ams**.

3.1 Hardware Architecture

The Evaluation Kit includes an LDO to provide the 1.8V supply voltage for the AS7341. ESD protection diodes for the I²C bus and GPIO lines. Placeholder for optional LEDs. The LEDs can be supplied either from the FTDI adapter or externally via TLP1. A 10 pol. IDC socket for connecting the FTDI adapter cable (J1) and 1/10 inch rows of holes for mounting on a 1/10inch hole-grid-plate or to directly contact signals. (TLP1...2) TLP3 is not used.

Figure 3 :
Board Block Diagram

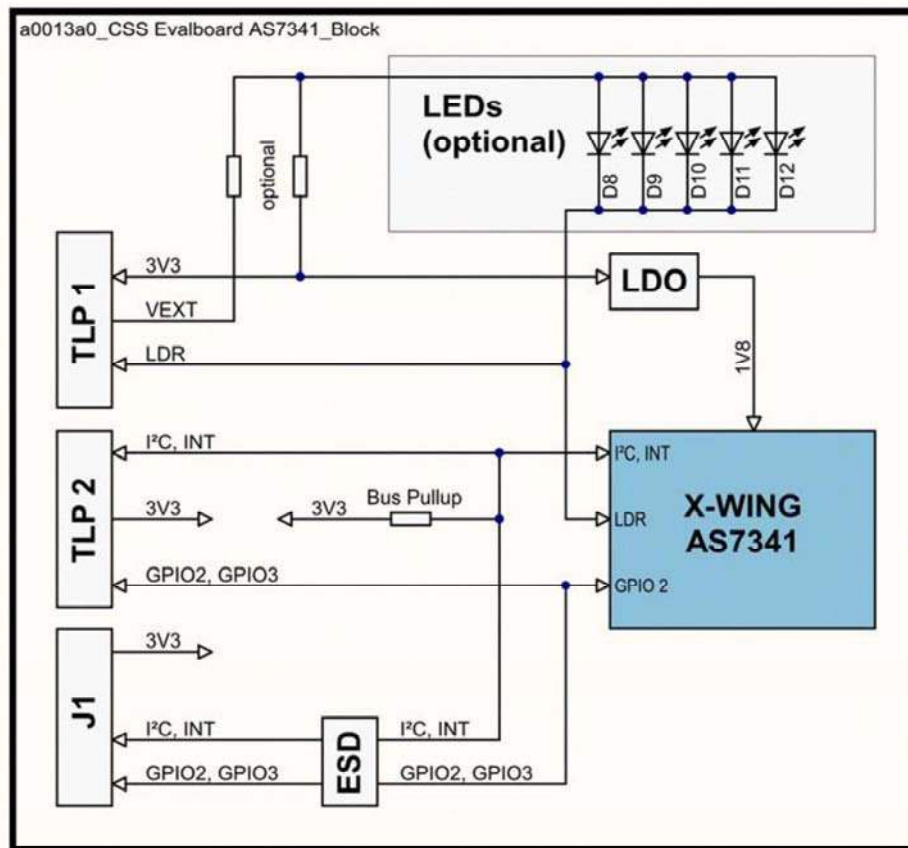

3.2 Power Supply

Power supply is provided by the FTDI cable version 3.3 V. Note, this adapter is part of the original AS7341 Evaluation Kit.

➤ Make sure to use the original adapter before connecting the hardware to USB.

3.3 Connector Pinout Description

The following chapters describe the pinout of the a0013a0_CSS Evalboard AS7341.

Figure 4 :
Connector Pinout Description

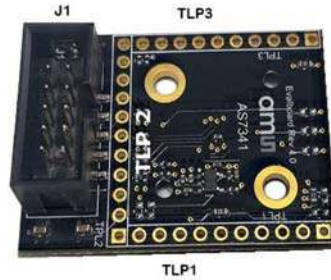

Figure 5:
Overview Connectors and Interfaces (see Figure 4)

Designator	Comment
J1	10 pol. IDC Socket, connect to a personal computer via FTDI Adapter (3.3 V Version)
TLP 1	VEXT, LDR, GND
TLP 2	3V3(5V0), I ² C, INT, GPIO
TLP 3	GND

Figure 6:
Connectors in Detail

Pin Number	Net Name	Function
TLP1		
1	VEXT	Supply the optional fitted LEDs from an external source
2	GND	Ground
3	LDR	Constant current sink from AS7341
4...9	NC	Not connected
10	1V8	External power supply for AS7341. Before using this pin, disassemble the LDO.
TLP 2		
1	GND	Ground
2	NC	Not connected
3	3V3	3V3 power input if there is no power on J1 (FTDI adapter) or 3V3 power output, if the power comes over J1
4	GND	Ground
5	SDA	I ² C Data Signal
6	SCL	I ² C Clock Signal
7	INT	AS7341 Interrupt Signal
8	GPIO 2	GPIO signal, bridged to the FTDI adapter
9	GND	Ground
10	GPIO 3	GPIO signal, bridged to the FTDI adapter and the AS7341
11	SDA2	Is normally bridged to SDA, only needed for FTDI adapter
TLP 3		
1..5, 7..10	NC	Not connected
6	GND	Ground
J1		
1	NC	Not connected
2	3V3	3V3 power input from the FTDI adapter
3	GND	Ground
4	SDA	I ² C Data Signal
5	SCL	I ² C Clock Signal
6	INT	AS7341 Interrupt Signal
7	GPIO 2	GPIO signal, bridged to TPL 2
8	GND	Ground
9	GPIO 3	GPIO signal, bridged to the AS7341
10	SDA2	Is normally bridged to SDA, only needed for FTDI adapter

3.4 Schematic Drawing

The schematic and the assembly drawing of the a0013a0_CSS Evaluation board AS7341 are shown in Figure 7.

Figure 7 :
Schematic

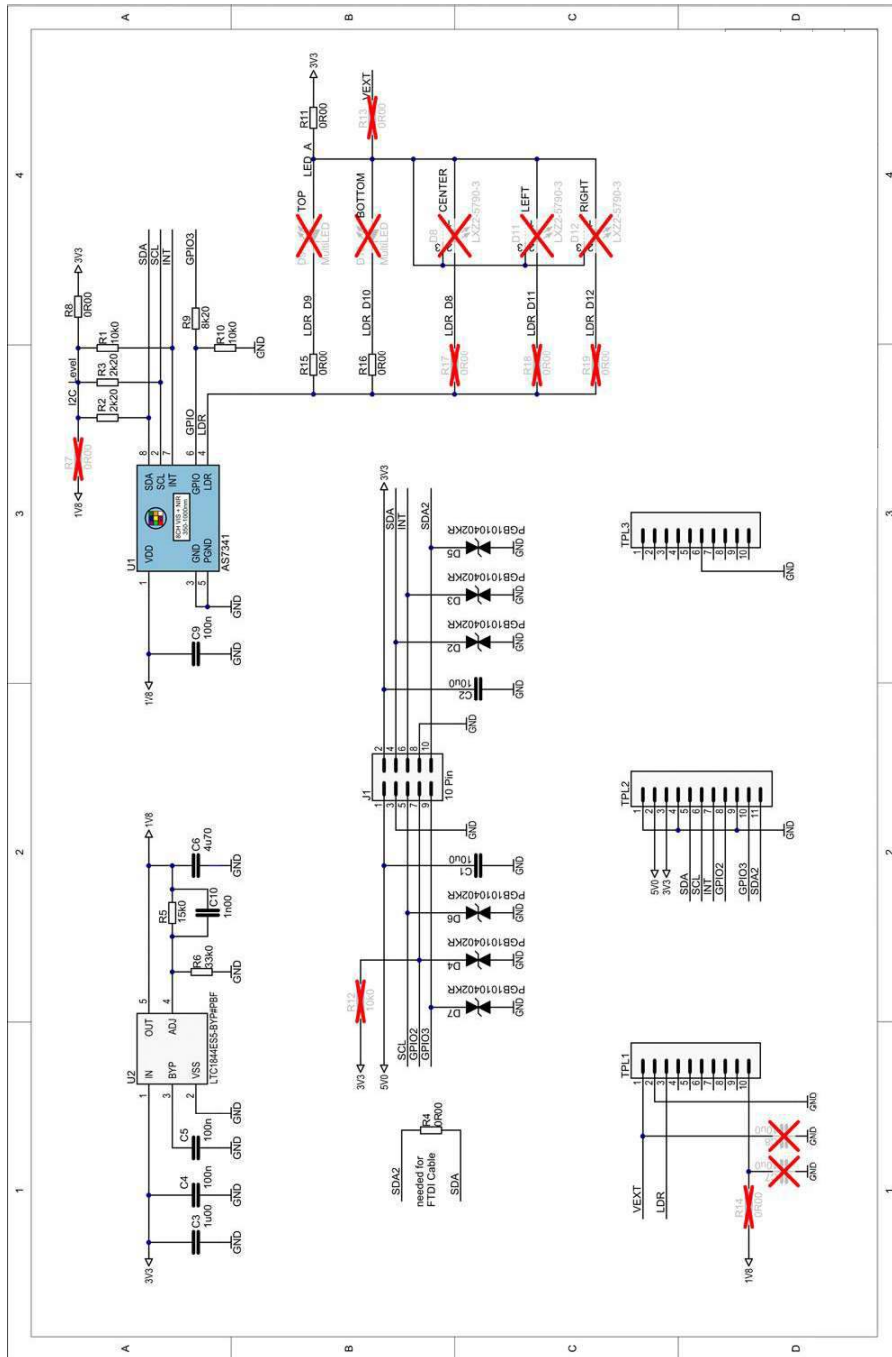

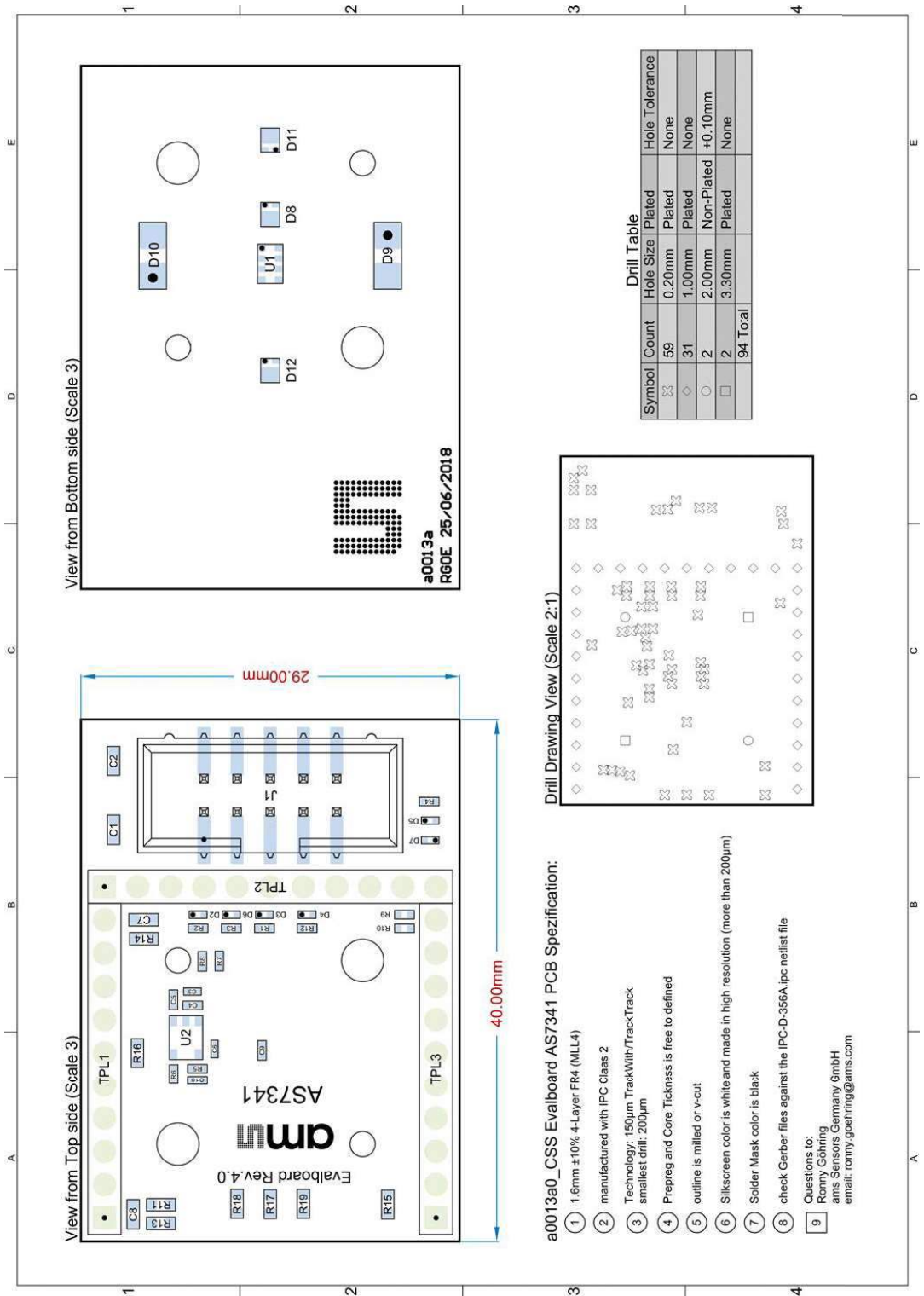

4 Optical Diffuser

For optimal performance, an achromatic bulk diffuser is recommend. The diffuser should sit directly above the sensor device.

➤ Note, the diffuser specification is depending on the customer application. Therefore, check the technical parameters of the standard diffuser (see Figure 8 for technical details) before you start any tests. The diffuser can be changed very fast and easy. Be careful and do not touch diffusers with fingers in case in case of any mounting activities. The surface of diffusers is very sensitive and any touches or other mechanical stress or dirty can change the optical behavior dramatically.

A recommend diffuser is pre-mounted in the AS7310L Evaluation kit direct above the sensor by using to simple plastic shells, which are fixed on the evaluation kits by screws.

Figure 8 displays the recommend diffuser parameters.

Figure 8:
Diffuser Parameters

Parameter	Value
Diffuser Material	Kimoto 100 PBU
Diffuser Thickness	125 microns
Transmission	66%
Haze	89.5%
Half-Angle	35.5°

5 Software

5.1 Software Installation

The GUI AS7341 is for Windows 10 based systems where .net Framework 4.5.2 or later versions is pre- installed. Before connecting the FTDI adapter to the computer, the FTDI driver must installed. Start the CDM21216_Setup.exe and follow the instructions. Then connect the Evaluation board to the computer via the FTDI adapter. Start the GUI Install software from USB stick and follow here all instructions (AS7341_Demo_Software.exe or *.msi). Then start the GUI from Windows start / ams / AS7341. It should show the Main Window and the successful connection to the EVAL board in the status bar and footer line.

Figure 9 :
Main Window in GUI and Status Bar

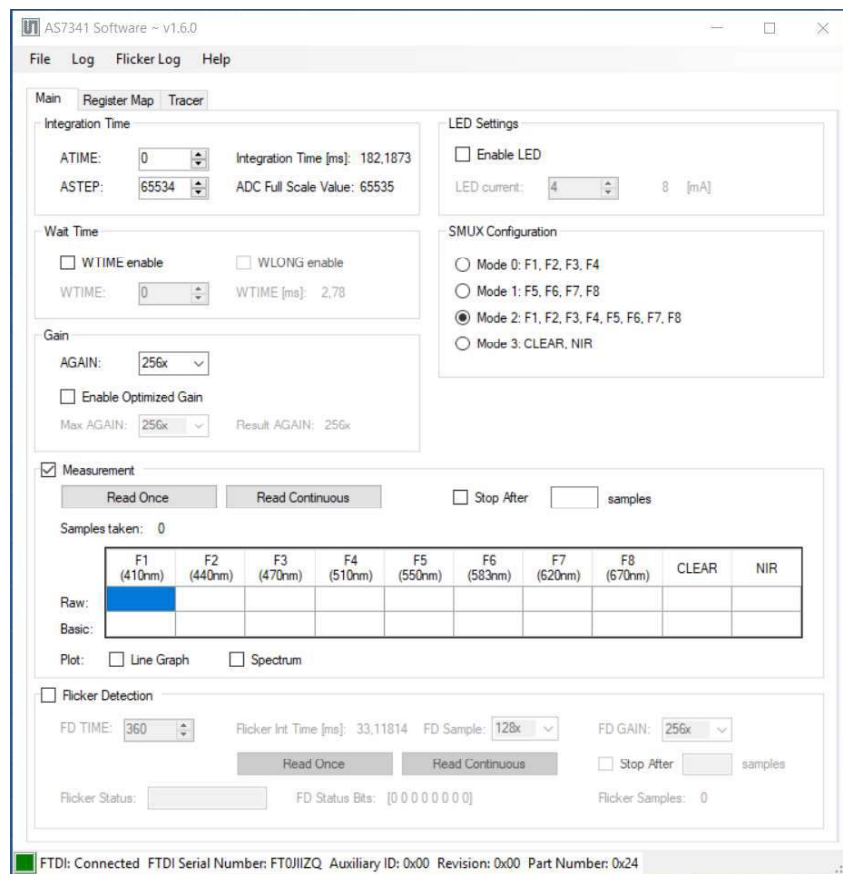

5.2 AS7341 EVM Graphical User Interface

Connect the AS7341 hardware to the system via a FTDI cable and double-click the software icon to open the software GUI. If there are more than two FTDI cables connected to the computer, it would popup the window as below Figure 10.

Figure 10 :
Window for FTDI Cable Selection if Multiple FTDI Cable Connected

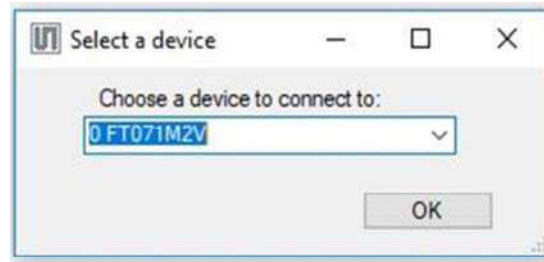

Please select the correct cable used for the evaluation board and click "OK". If there is only one FTDI cable, the software will automatically select the connected cable.

When everything with the connection is fine, a GUI window will launch automatically with the sensor connected to the PC as in below Figure 11. The GUI consists of different parts as marked in colored rectangles. The bottom section will display the status of FTDI connection, FTDI cable series number, sensor auxiliary ID, revision and part number.

Check the part number includes any 0x-code in case of any issues. A code 0x zero points to a not connected sensor hardware. In case of an issue, check the USB driver installation and connections start the software again or use the scan function in menu File.

5.3 Sensor Board Test

To check the function of the a0013a0_CSS Evaluation board AS7341, set (see Figure 9) AGAIN = 256x, ATIME = 0, ASTEP = 65534 (TINT = 182 ms) and start the measurement by pressing the "Read Once" button under "Measurement" on the "Main" tab. Now one measurement step is running and it should show measured values in the table based on sensor's location to a luminary in front of the sensor. Change integration time (ATIME ad ASTEP) and AGAIN to change the digits based on application requirements.

More details about sensor functions and the parameters are listed in sensor's data sheet or later in this manual.

Figure 11 :
First Sensor Board Test

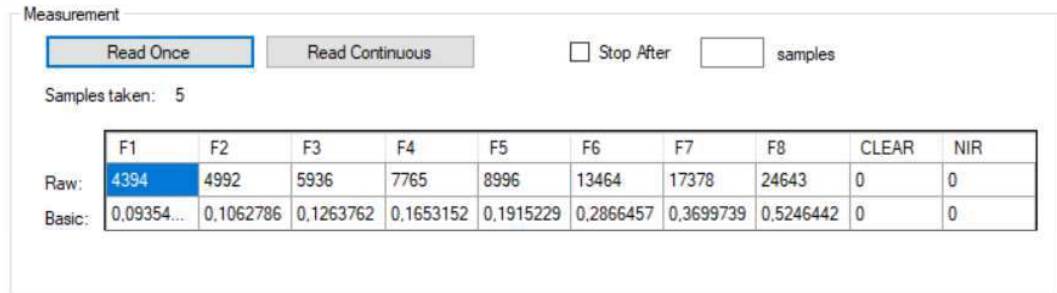

Select one of the Plot options Line Graph or Spectrum to see the results as graphical output.

Figure 12 :
Sensor Results as Spectrum

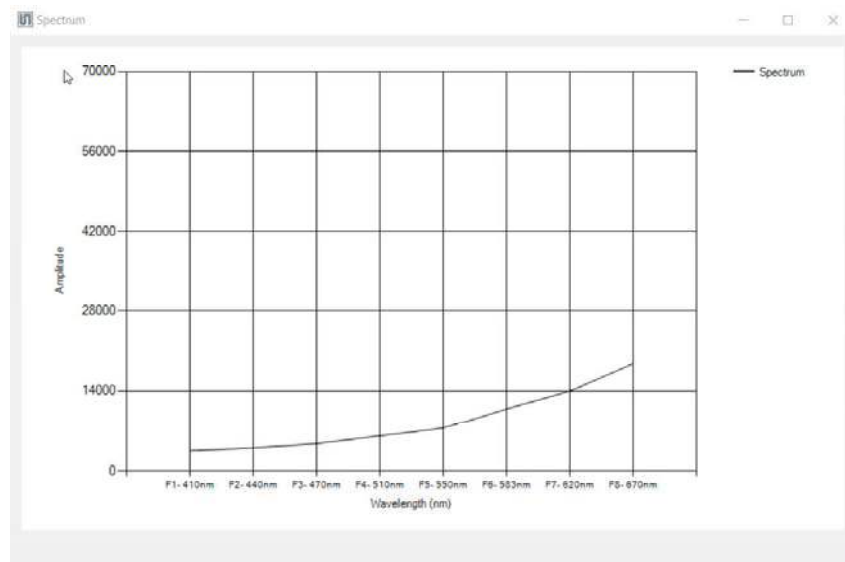

5.4 Tab File

The GUI will automatically open, when launching the software. If no device is connected, an error message will be displayed. On the other hand, if no device connected it will pop up an error message.

The GUI starts showing a red indicator at the bottom section of the FTDI connection. Now connect a device, navigate to the file tab in top corner of the GUI and click “Scan and Connect”. The GUI will relaunch with the device connected. Use the “Disconnect” button to terminate the connection. “Exit” button to end the GUI application.

5.5 Tab Log

The 'Log file' is to store sensor setup and data in a CSV data Excel format. Click 'Start Logging' and/or 'Stop Logging' to select the samples and close up the process by 'Save Log' to store the CSV file and/or 'Clear Log' to delete the sampled Log data.

Figure 13 :
Example CSV Logfile

Sample num	SMUX config	ATIME	ASTEP	T_INT [ms]	WTIME _EN	WTIME [ms]	WTIME [ms]	AGAI N	AGAIN [x]	AGC_EN	AGAIN _Result	AGAIN _Result [x]
1	2	132	599	221,8	FALSE	0	2,78	9	256	FALSE	9	256
LED_EN	LED_C current	LED_Curr ent [ms]	F1	F8	CLEAR	NIR	Basic F1	...	Basic F8	Basic CLEAR	Basic NIR
FALSE	4	8	23808		50688	22528	5376	0,419214	0,829412	0,892519	0,396675	0,094661

5.6 Menu Flicker Log

The Flicker Log functions are identical to the menu Log functions. The only difference is that they solely store the Flicker data.

5.7 Main Page

The main page (see Figure 9) contains the user interface with control buttons, fields, selection boxes and output values for the identified device connected.

The main page allows configuring the AS7341 device and initializes the default setting to the devices. It allows the user to modify and configure the Integration time setting, Gain setting, LED setting, Auto zero, SMUX Configuration, Optimized gain control, flicker detection etc.

Integration Time: Integration time is one parameter to affect the sensor result = digital counts or digits. The higher the counts, the better the'. Note, the integration time affects direct the saturation (FSR 16 bit = 2^16 is reached for first time at 182 ms = 2.78 μs * 2^16).

The integration time is set using ATIME (0x81) and ASTEP (0xCA, 0xCB) registers. The integration time is in millisecond. It is calculated using the equation -

$$t_{int} = (ATIME + 1) \times (ASTEP + 1) \times 2.78 \mu s$$

The integration time parameter like the ATIME and ASTEP can be set by clicking the up or down arrow button. ATIME sets the number of integration steps from 1 to 255. Sets the integration time per step in increments of 2.78 μ s. ASTEP sets the integration time from 1 to 65534 steps.

The reset value for ASTEP is 999 (2.78 ms) and the default configuration in GUI for these two registers are ASTEP = 599 and ATIME = 29, which results in an integration time of 50ms. It is not allowed that both settings –ATIME and ASTEP – are set to “0”.

Gain Setting: Gain is the second parameter to affect the sensor result = digital counts.

➤ The higher the counts, the better the accuracy. Therefore, select always between changings of Gain and TINT in the parameter setup to get an optimized result and avoid measurements nearly in noise or with risk of saturation. The optimized working range is between 40% and 80% of FSR depending on TINT.

The gain control allows the user access to the gain settings in the 0xAA Register (4:0 bits). The gain amplifies the 6 integrated ADCs signal to increase sensitivity. The gain options include 0.5x, 1x, 2x, 4x, 8x, 16x, 32x, 64x, 128x, 256x, and 512x. These can be selected from the list box when the down arrow is pressed.

Enable “Optimized Gain” to switch on an algorithm of the GUI, which analyzes an optimal gain setting, based on the pre-selected integration time. The algorithm starts always with the highest gain and check with this setup for saturation depending on the SMUX configuration. The algorithm will decrease gain in case of any saturation and start the check again until no saturation is achieved. In this case, the algorithm fixes the actual gain as optimized gain. Otherwise, an error message will printed out in case of no gain without saturation was found with the selected integration time. So happen, adapt integration and starts the process again.

➤ Note, a higher integration makes the sensor response lower. The sensor must measure n-times to find an optimized gain. Therefore, do not increase integration time (result from multiplying ATIME and ASTEP) too much or accept longer a response time.

User can also set a maximum gain value to consider for the Optimized Gain control in Max GAIN list box.

Wait Time: WTIME enable check box enables or disables the WEN bit in ENABLE register (0x80). When it is checked, the wait time between two consecutive spectral measurements is enabled. unchecking disables WTIME. WTIME can be set by using the up or down control button.

Wait time is calculated as

$$\text{Wait time} = (\text{WTIME} + 1) \times 2.78 \mu\text{s}$$

WTIME is 8-bit value sets the number of steps from 0 to 255. Sets the wait time per step in increments of 2.78 ms with a maximum value of 711 ms.

The measurement after enabling will be also depended on the WLONG.

WLONG: Enable or disable the WLONG bit (bit 2) in 0XA9 register. When asserted, the wait time WTIME is increased by a factor 16x.

LED Setting: Check Enable for switch on the LED and set LED currents. Enabling or disabling the LED_ACT bit (bit 7) of register 0x74. The current can be set using the up-down control on LED_DRIVE bits (6:0) of register 0xB1. It has a range from 4 mA to 258 mA.

SMUX Configuration: The device integrates a multiplexer (SMUX). With the SMUX, it is possible to map all available photo diodes to one of the six available light to frequency converter (ADC0 to ADC5). After power up of the device, the SMUX needs to be configured before a spectral measurement is started. Here the SMUX configured to three different modes where user can see the corresponding selected channels in the selected mode.

Flicker Detection: Flicker Detect Enabled with the check box to high. During the flicker detection the enable register (0x80) fden (6 bit) and pon (0 bit) bit is set to high. Flicker time is calculated with FD TIME and FD SAMPLE

$$\text{fd_measurement_time} = \text{fd_samples} * (\text{fd_time} + 1) * 2.78 \mu\text{s}$$

The Flicker measurement time parameter like the FDTIME and FDSAMPLE can be set by clicking the up or down and list box respectively. FDTIME is sets the number of integration steps from 1 to 2047 in 0xDA the lower part (7:0) and 0xDA (2:0) the higher part. Sets the integration time per step in increments of 2.78μs.

FD Samples sets the number of samples to measure between updates. FD Sample is varied in list box with the predefined values ranging from 8x, 16x, 32x, 64x, 128x 256x 512x and 1024x in 0xD7 register (5:3 bits).

The FD Gain control allows the user access to the FD Gain settings in the 0xDA Register (7:3 bits). The gain options include 0.5x, 1x, 2x, 4x, 8x, 16x, 32x, 64x, 128x, 256x, and 512x. These can be selected from the list box when the down arrow is pressed.

FD Status displays the status of the flicker detected from the 0xDB register. 4th bit (fd_saturation_detected) indicates that the upper boundary limit of the internal calculations was reached and values were saturated. 3rd bit (fd_120Hz_flicker_valid) '1' it shows that fd_120Hz_flicker is valid. 2nd bit (fd_100Hz_flicker_valid) '1' is shows that fd_100Hz_flicker is valid. 1st bit (fd_120Hz_flicker) '1' means 120Hz flicker detected. 0th bit (fd_100Hz_flicker) '1' means 100Hz flicker detected.

Measurement Setting: Select 'Read once' or 'Read Continuous' to measure step by step or in continuous mode (alternative with a specified number of steps) and/or to stop a continuous mode after n steps. The ADC results are printed out after each measurement as numeric values presenting Raw or calculated basic values.

Raw values are represent the counts from the ADC depending on the used setup (SMUX Configuration, Gain, Integration time, LED-current etc). The basic value is calculated on base of the raw measurement values and the corresponding again and integration time at that time to get sensor results not depend on the parameter setup (gain, TINT).

$$\text{basic_val} = (\text{raw_val}) / (\text{gain} * \text{tint_ms})$$

Note, the basis values must be considered/defined/calculated application specific, especially in case of a dynamic conversion and during algorithm's for sensor corrections.

5.8 Register Mapping

The "Register Table" page lists and allows writing all I2C registers values with the address, the name and information about authorization to read or write.

Figure 14 : Register Mapping Table

Register Address	Name	b7	b6	b5	b4	b3	b2	b1	b0	Current Value
0x60	ASTATUS_SYND	0				0	0	0	0	0x00
0x61	CH0_DATA_SYND_L	0	0	0	0	0	0	0	0	0x00
0x62	CH0_DATA_SYND_H	0	0	0	0	0	0	0	0	0x00
0x63	ITIME_L	0	0	0	0	0	0	0	0	0x00
0x64	ITIME_M	0	0	0	0	0	0	0	0	0x00
0x65	ITIME_H	0	0	0	0	0	0	0	0	0x00
0x66	CH1_DATA_SYND_L	0	0	0	0	0	0	0	0	0x00
0x67	CH1_DATA_SYND_H	0	0	0	0	0	0	0	0	0x00
0x68	CH2_DATA_SYND_L	0	0	0	0	0	0	0	0	0x00
0x69	CH2_DATA_SYND_H	0	0	0	0	0	0	0	0	0x00
0x6a	CH3_DATA_SYND_L	0	0	0	0	0	0	0	0	0x00
0x6b	CH3_DATA_SYND_H	0	0	0	0	0	0	0	0	0x00
0x6c	CH4_DATA_SYND_L	0	0	0	0	0	0	0	0	0x00
0x6d	CH4_DATA_SYND_H	0	0	0	0	0	0	0	0	0x00
0x6e	CH5_DATA_SYND_L	0	0	0	0	0	0	0	0	0x00
0x6f	CH5_DATA_SYND_H	0	0	0	0	0	0	0	0	0x00
0x70	CONFIG					0	0	0	0	0x00
0x71	STAT							0	0	0x00
0x72	EDGE	0	0	0	0	0	0	0	0	0x00
0x73	GPIO							0	0	0x00
0x74	LED	0	0	0	0	0	1	0	0	0x04
0x80	ENABLE		0		0	0		1	1	0x03

FTDI: Connected FTDI Serial Number: FT0JIIZQ Auxiliary ID: 0x00 Revision: 0x00 Part Number: 0x24

Click the “Read values from sensor” button to update the whole table. It is recommend to update the table when coming or leaving this page. Write a value to a register by clicking the “Current Value” cell that corresponds to the register and typing a new value into the cell. Then click the “Write values to sensor” button to program value into the device. After the update, by clicking the “Read values from sensor” button the value in the register is refreshed and confirmed. Use the “Save register table” to make an external copy of all register and values into a csv-file.

➤ Note: The application synchronizes the changes on the Main Page and the Register Table Page automatically.

5.9 Tracer

The Tracer controls the software process by using pre-designed scripts in txt format. Such scripts can be loaded, saved, proceeded or cleared. Log is a protocol function and cab be saved or cleared. Figure 15 and following show the Window Tracer with an example code for a pre-designed script with log.

The following commands are implemented in the actual Tracer function:

Load Script: read the pre-designed text file or saved script

Save Script: save the current script

Run Script: execute the current script,

Clear Script: delete the text of the script text box,

Save Log: save the current log (right text box) file,

Clear Log: delete the text of the log text box.

Execute read, write commands and pauses by using the following syntax:

Read: "R Register_Address" or "r Register_Address" (e.g. "R 80")

Write: "W Register_Address Register value" or "r Register_Address Register value" (e.g. "R 80 00")

Pause: "PAUSE Time_ms" (e.g. "PAUSE 1000" -> A pause of 1000 ms)

#Comment: -> e.g. "# Reading register 0x80"

➤ Note, register address and register value are always specified as hexadecimal numbers without 0x. Comments can be placed directly behind a command or in a new line. Upper and lower case is neglected

Figure 15:
Tracer Window with Example Code

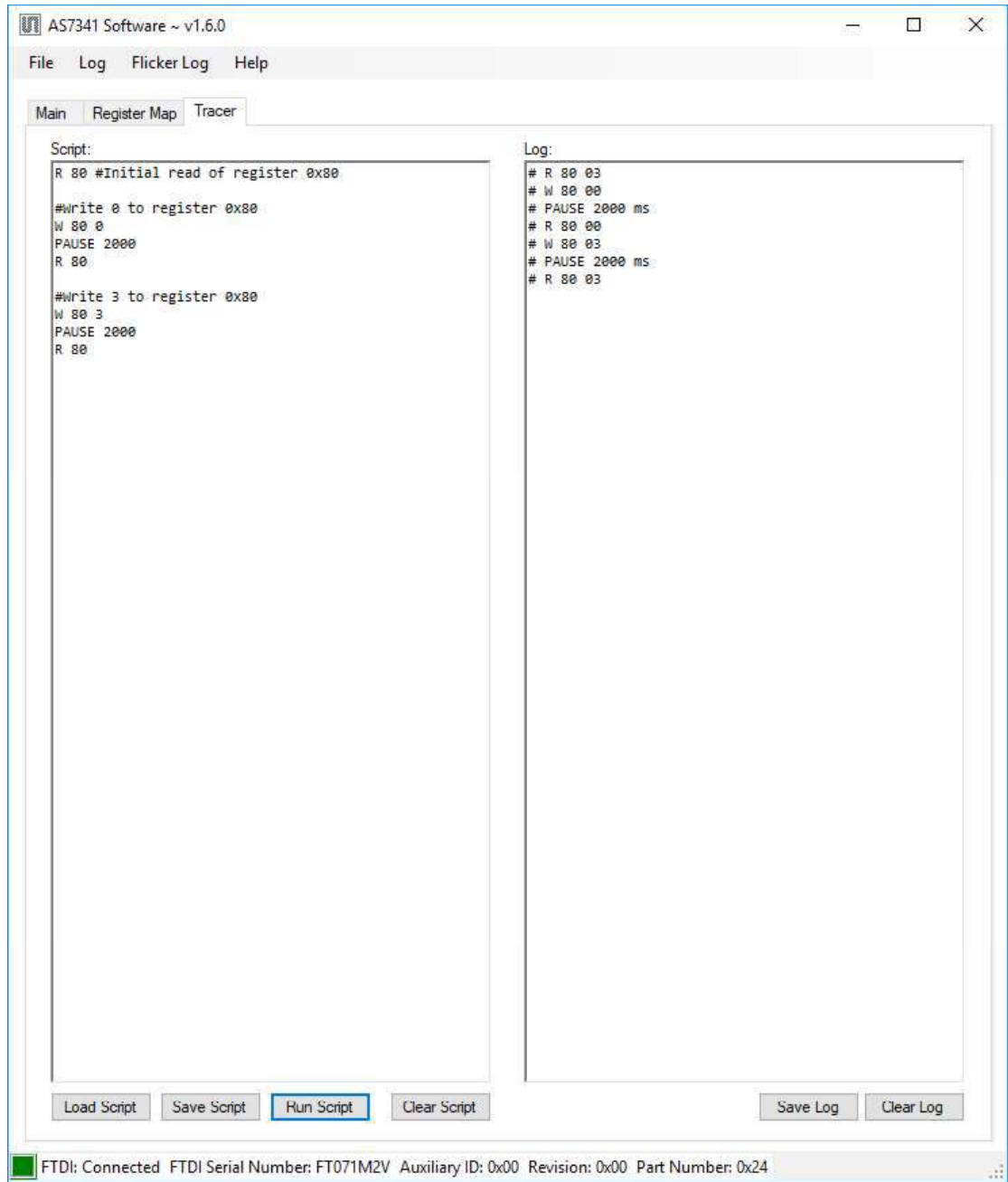

Figure 16 and Figure 17 show samples for a script and a script log.

Figure 16:
Sample Script

```
R 80 #Initial read of register 0x80

#Write 0 to register 0x80

W 80 0

PAUSE 2000

R 80

#Write 3 to register 0x80

W 80 3

PAUSE 2000

R 80
```

Figure 17:
Sample Script Log

```
# R 80 03

# W 80 00

# PAUSE 2000 ms

# R 80 00

# W 80 03

# PAUSE 2000 ms

# R 80 03
```

6 Revision Information

Changes from previous version to current revision v2-00	Page
V1-00 Initial version for release	all
V2-00 Chapter 1.1 Aperture for diffuser	3
V2-00 Chapter 3.5 Software installation	11
V2-00 Tracer function	19
V2-00 Chapter 1.1 / 2 New Diffuser and adapter	3, 5

- Page and figure numbers for the previous version may differ from page and figure numbers in the current revision.
- Correction of typographical errors is not explicitly mentioned.

7 Legal Information

Copyrights & Disclaimer

Copyright ams AG, Tobelbader Strasse 30, 8141 Premstaetten, Austria-Europe. Trademarks Registered. All rights reserved. The material herein may not be reproduced, adapted, merged, translated, stored, or used without the prior written consent of the copyright owner.

Demo Kits, Evaluation Kits and Reference Designs are provided to recipient on an "as is" basis for demonstration and evaluation purposes only and are not considered to be finished end-products intended and fit for general consumer use, commercial applications and applications with special requirements such as but not limited to medical equipment or automotive applications. Demo Kits, Evaluation Kits and Reference Designs have not been tested for compliance with electromagnetic compatibility (EMC) standards and directives, unless otherwise specified. Demo Kits, Evaluation Kits and Reference Designs shall be used by qualified personnel only.

ams AG reserves the right to change functionality and price of Demo Kits, Evaluation Kits and Reference Designs at any time and without notice.

Any express or implied warranties, including, but not limited to the implied warranties of merchantability and fitness for a particular purpose are disclaimed. Any claims and demands and any direct, indirect, incidental, special, exemplary or consequential damages arising from the inadequacy of the provided Demo Kits, Evaluation Kits and Reference Designs or incurred losses of any kind (e.g. loss of use, data or profits or business interruption however caused) as a consequence of their use are excluded.

ams AG shall not be liable to recipient or any third party for any damages, including but not limited to personal injury, property damage, loss of profits, loss of use, interruption of business or indirect, special, incidental or consequential damages, of any kind, in connection with or arising out of the furnishing, performance or use of the technical data herein. No obligation or liability to recipient or any third party shall arise or flow out of ams AG rendering of technical or other services.

RoHS Compliant & ams Green Statement

RoHS Compliant: The term RoHS compliant means that ams AG products fully comply with current RoHS directives. Our semiconductor products do not contain any chemicals for all 6 substance categories, including the requirement that lead not exceed 0.1% by weight in homogeneous materials. Where designed to be soldered at high temperatures, RoHS compliant products are suitable for use in specified lead-free processes.

ams Green (RoHS compliant and no Sb/Br): ams Green defines that in addition to RoHS compliance, our products are free of Bromine (Br) and Antimony (Sb) based flame retardants (Br or Sb do not exceed 0.1% by weight in homogeneous material).

Important Information: The information provided in this statement represents ams AG knowledge and belief as of the date that it is provided. ams AG bases its knowledge and belief on information provided by third parties, and makes no representation or warranty as to the accuracy of such information. Efforts are underway to better integrate information from third parties. ams AG has taken and continues to take reasonable steps to provide representative and accurate information but may not have conducted destructive testing or chemical analysis on incoming materials and chemicals. ams AG and ams AG suppliers consider certain information to be proprietary, and thus CAS numbers and other limited information may not be available for release.

Headquarters

ams AG
Tobelbader Strasse 30
8141 Premstaetten
Austria, Europe
Tel: +43 (0) 3136 500 0

Please visit our website at www.ams.com

Buy our products or get free samples online at www.ams.com/Products

Technical Support is available at www.ams.com/Technical-Support

Provide feedback about this document at www.ams.com/Document-Feedback

For sales offices, distributors and representatives go to www.ams.com/Contact

For further information and requests, e-mail us at ams_sales@ams.com