

## JENNY-60

~60° beam

### SPECIFICATION:

Dimensions	35.0 x 35.0 mm
Height	13.4 mm
Fastening	pin
ROHS compliant	yes ⓘ

### MATERIALS:

Component	Type	Material	Colour	Finish
JENNY-60	Single lens	Silicone	clear	

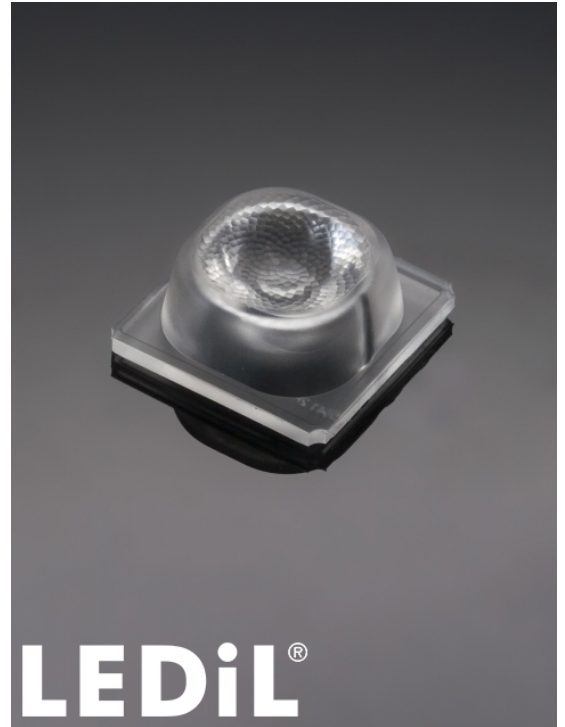

### ORDERING INFORMATION:

Component	Qty in box	MOQ	MPQ	Box weight (kg)
F15541_JENNY-60 » Box size: 480 x 280 x 300 mm	1200	120	60	9.9

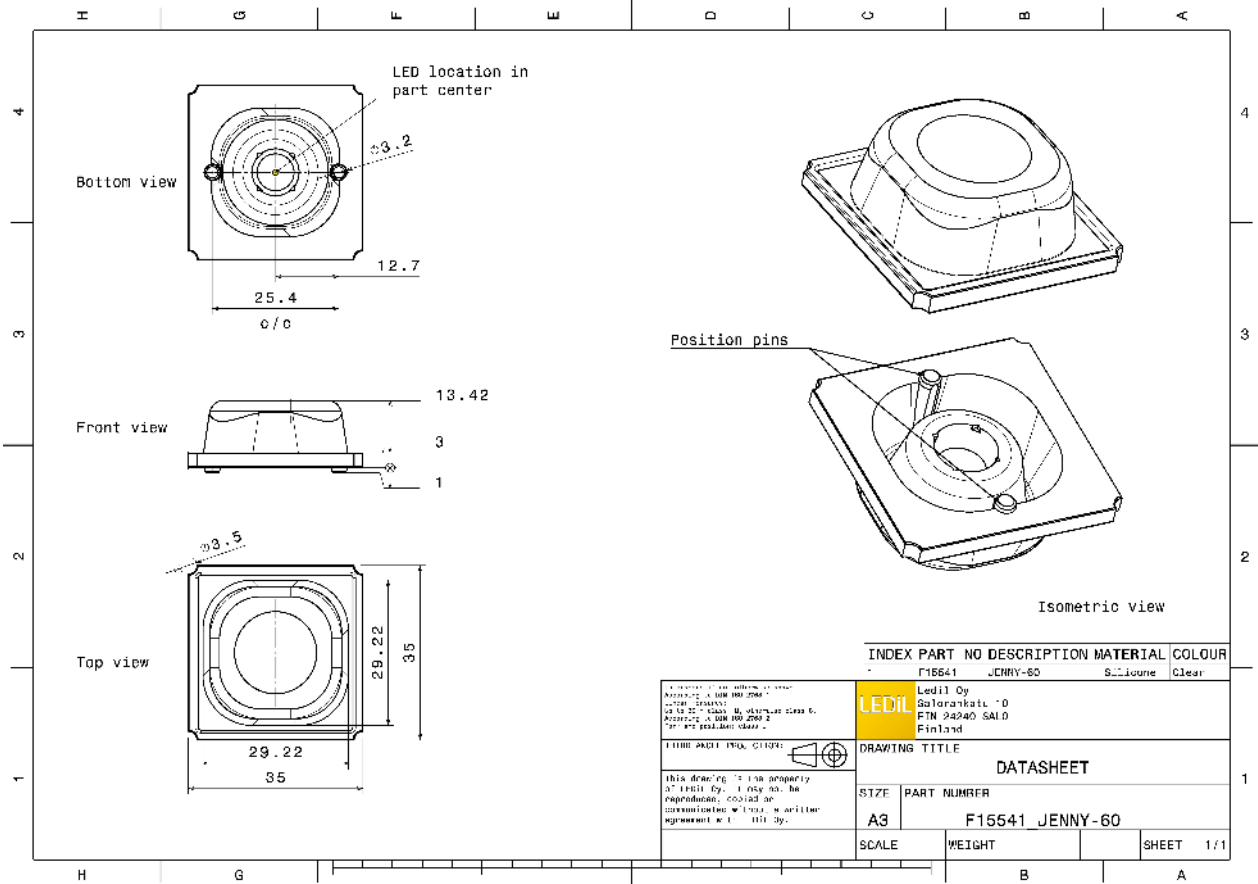





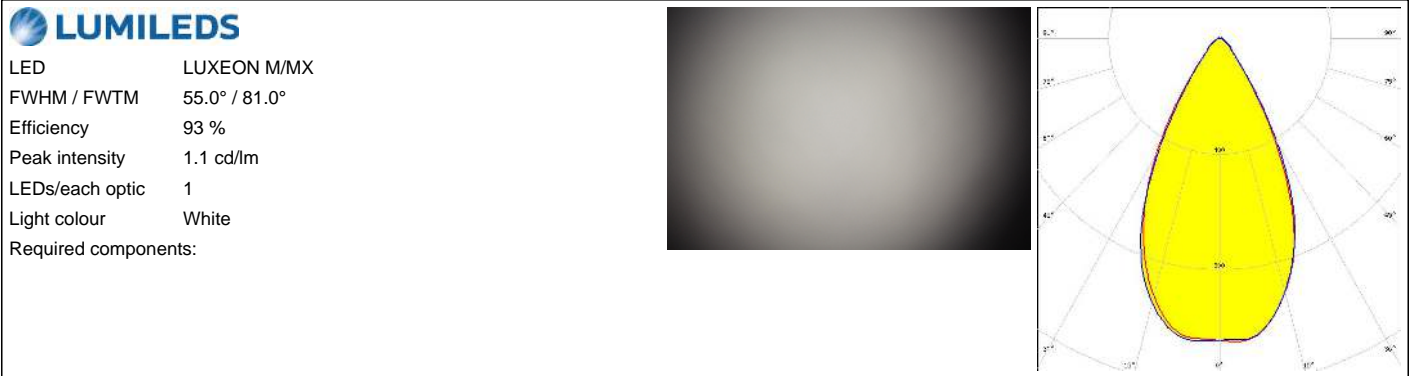

See also our general installation guide: [www.ledil.com/installation\\_guide](http://www.ledil.com/installation_guide)

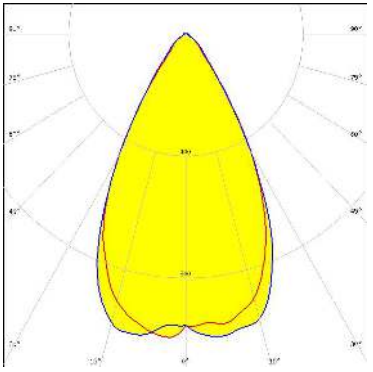
### OPTICAL RESULTS (MEASURED):

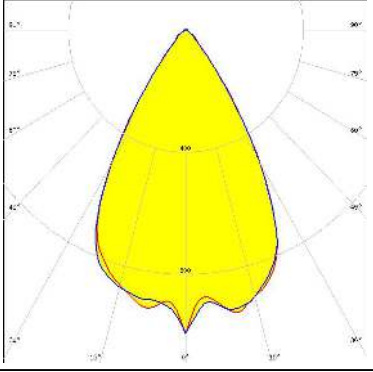

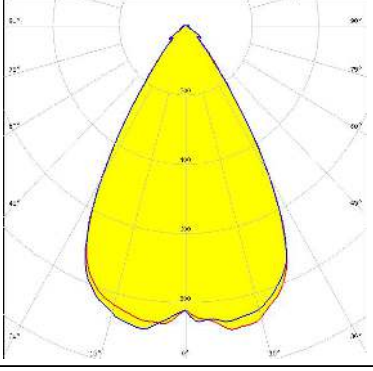
#### OPTICAL RESULTS (SIMULATED):

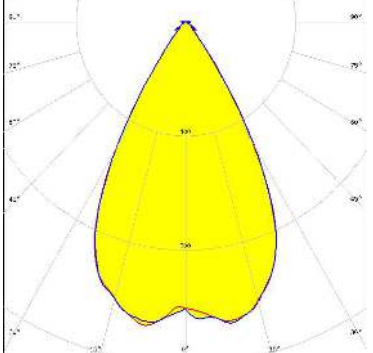
	<p>LED MHD-E/G            FWHM / FWTM 57.0° / 84.0°            Efficiency 94 %            Peak intensity 1 cd/lm            LEDs/each optic 1            Light colour White            Required components:</p>	
	<p>LED MK-R            FWHM / FWTM 57.0° / 82.0°            Efficiency 95 %            Peak intensity 1 cd/lm            LEDs/each optic 1            Light colour White            Required components:</p>	
	<p>LED XHP50.3 HD            FWHM / FWTM 62.0° / 86.0°            Efficiency 96 %            Peak intensity 0.9 cd/lm            LEDs/each optic 1            Light colour White            Required components:</p>	
	<p>LED XHP50.3 HI            FWHM / FWTM 58.0° / 77.0°            Efficiency 97 %            Peak intensity 1.1 cd/lm            LEDs/each optic 1            Light colour White            Required components:</p>	

#### OPTICAL RESULTS (SIMULATED):

##### CREE LED

LED XHP70  
 FWHM / FWTM 59.0° / 86.0°  
 Efficiency 93 %  
 Peak intensity 1 cd/lm  
 LEDs/each optic 1  
 Light colour White  
 Required components:

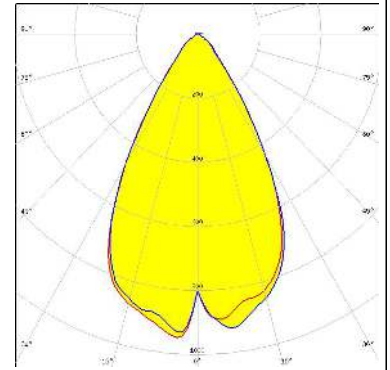

##### CREE LED

LED XHP70.3 HD  
 FWHM / FWTM 62.0° / 92.0°  
 Efficiency 96 %  
 Peak intensity 0.9 cd/lm  
 LEDs/each optic 1  
 Light colour White  
 Required components:

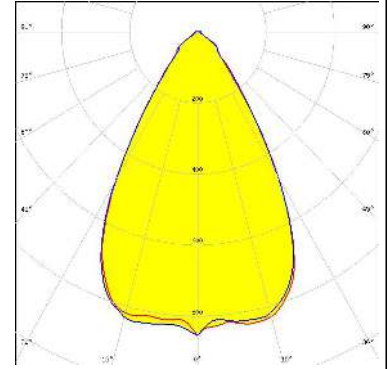

##### CREE LED

LED XHP70.3 HI  
 FWHM / FWTM 56.0° / 77.0° + 78.0°  
 Efficiency 97 %  
 Peak intensity 1.2 cd/lm  
 LEDs/each optic 1  
 Light colour White  
 Required components:

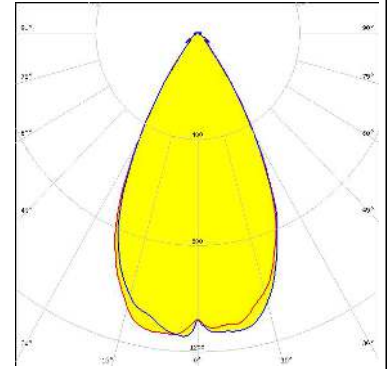

##### LUMILEDS

LED LUXEON 7070  
 FWHM / FWTM 54.0° / 80.0°  
 Efficiency 91 %  
 Peak intensity 1.1 cd/lm  
 LEDs/each optic 1  
 Light colour White  
 Required components:

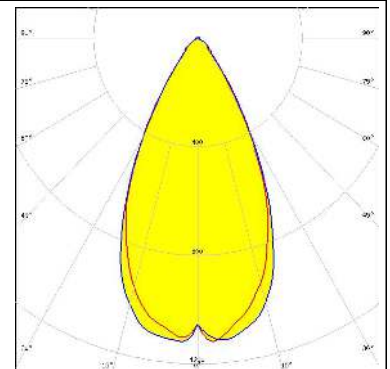

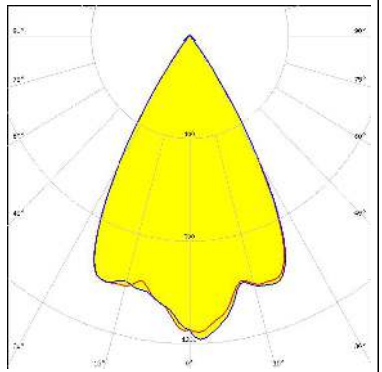
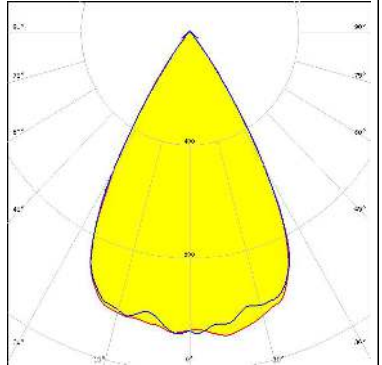
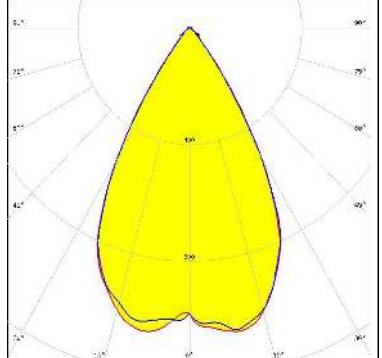
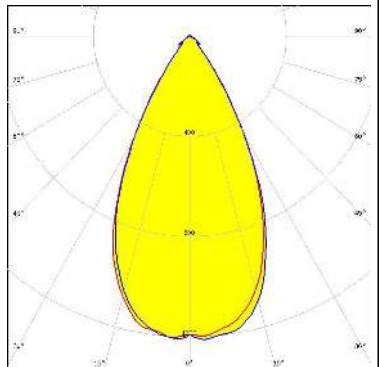

#### OPTICAL RESULTS (SIMULATED):

<p><b>LUMINUS</b></p> <p>LED SFT-40-WCS            FWHM / FWTM 60.0° / 74.0°            Efficiency 98 %            Peak intensity 1.2 cd/lm            LEDs/each optic 1            Light colour White            Required components:</p>	
<p><b>LUMINUS</b></p> <p>LED SFT-70X-WCS            FWHM / FWTM 60.0° / 76.0°            Efficiency 98 %            Peak intensity 1.1 cd/lm            LEDs/each optic 1            Light colour White            Required components:</p>	
<p><b>LUMINUS</b></p> <p>LED SST-70X-WCS            FWHM / FWTM 60.0° / 79.0°            Efficiency 97 %            Peak intensity 1.1 cd/lm            LEDs/each optic 1            Light colour White            Required components:</p>	
<p><b>NICHIA</b></p> <p>LED NFMW48xA            FWHM / FWTM 54.0° / 78.0°            Efficiency 97 %            Peak intensity 1.2 cd/lm            LEDs/each optic 1            Light colour White            Required components:</p>	

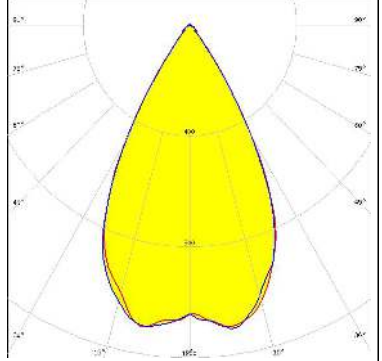
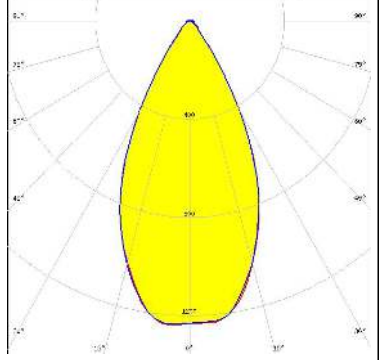
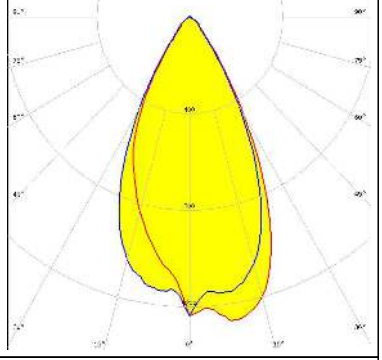
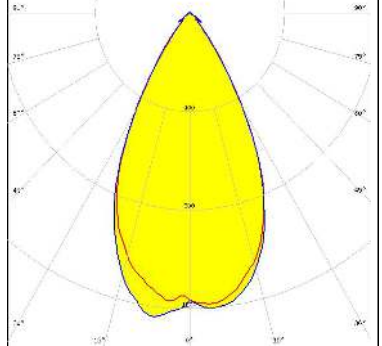
#### OPTICAL RESULTS (SIMULATED):

<p><b>NICHIA</b></p> <p>LED NV4WB35AM            FWHM / FWTM 58.0° / 76.0°            Efficiency 93 %            Peak intensity 1.2 cd/lm            LEDs/each optic 1            Light colour White            Required components:</p>	
<p><b>NICHIA</b></p> <p>LED NVSxE21A            FWHM / FWTM 51.0° / 77.0°            Efficiency 94 %            Peak intensity 1.3 cd/lm            LEDs/each optic 4            Light colour White            Required components:</p>	
<p><b>OSRAM</b>  <small>Opto Semiconductors</small></p> <p>LED Duris S10            FWHM / FWTM 49.0° / 77.0°            Efficiency 94 %            Peak intensity 1.3 cd/lm            LEDs/each optic 1            Light colour White            Required components:</p>	
<p><b>OSRAM</b>  <small>Opto Semiconductors</small></p> <p>LED Duris S8            FWHM / FWTM 50.0° / 77.0°            Efficiency 94 %            Peak intensity 1.2 cd/lm            LEDs/each optic 1            Light colour White            Required components:</p>	

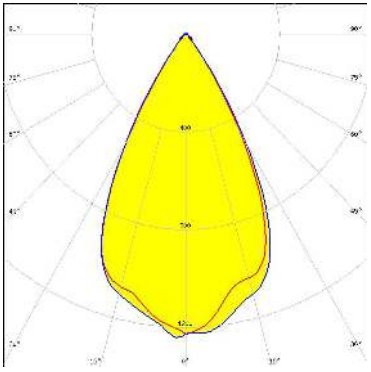
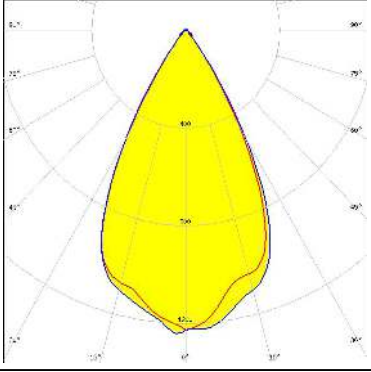
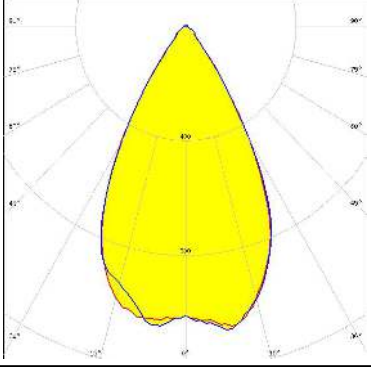
#### OPTICAL RESULTS (SIMULATED):

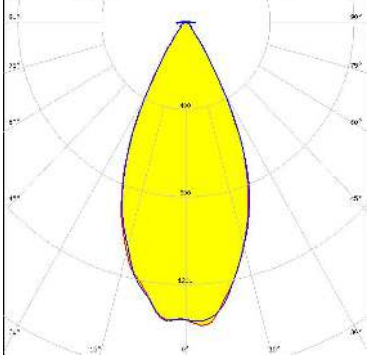
<b>OSRAM</b> <small>Opto Semiconductors</small>	<p>LED                    OSCONIQ P 3737 (2W version)</p> <p>FWHM / FWTM        56.0° / 75.0°</p> <p>Efficiency             97 %</p> <p>Peak intensity        1.2 cd/lm</p> <p>LEDs/each optic     1</p> <p>Light colour          White</p> <p>Required components:</p>	
<b>OSRAM</b> <small>Opto Semiconductors</small>	<p>LED                    OSCONIQ P 3737 (2W version)</p> <p>FWHM / FWTM        56.0° / 75.0°</p> <p>Efficiency             94 %</p> <p>Peak intensity        1.2 cd/lm</p> <p>LEDs/each optic     1</p> <p>Light colour          White</p> <p>Required components:</p>	
<b>OSRAM</b> <small>Opto Semiconductors</small>	<p>LED                    OSCONIQ P 7070</p> <p>FWHM / FWTM        55.0° / 79.0°</p> <p>Efficiency             95 %</p> <p>Peak intensity        1.1 cd/lm</p> <p>LEDs/each optic     1</p> <p>Light colour          White</p> <p>Required components:</p>	
 <small>SEOUL SEMICONDUCTOR</small>	<p>LED                    Z8Y22</p> <p>FWHM / FWTM        48.0° / 72.0°</p> <p>Efficiency             91 %</p> <p>Peak intensity        1.4 cd/lm</p> <p>LEDs/each optic     1</p> <p>Light colour          White</p> <p>Required components:</p>	



#### OPTICAL RESULTS (SIMULATED):



### GENERAL INFORMATION:

NOTE: The typical beam angle will be changed by different color, chip size and chip position tolerance. The typical total beam angle is the full angle measured where the luminous intensity is half of the peak value.

### MATERIALS:

As part of our continuous research and improvement processes, and to ensure the best possible quality and availability of our products, LEDiL reserves the right to change material grades without notice.

### PRODUCT DATA USER AGREEMENT AND DISCLAIMER:

The measured data in the provided downloadable LEDiL Product Datasheets and Mechanical 2D-Drawings is rounded and provided as reference for planning. LEDiL Oy's optical specifications have been verified by conducting performance testing of the products in accordance with the company's quality system. The reported data are averaged results of multiple measurements with typical variation. LEDiL Oy reserves the right to without prior notification make changes and improvements to its products.

LEDiL Oy assumes neither warranty, nor guarantee nor any other liability of any kind for the contents and correctness of the provided data. The provided data has been generated with highest diligence but the provided data may in reality not represent the complete possible variation range of all intrinsic parameters. Therefore, in certain cases a deviation from the provided data could occur.

LEDiL Oy reserves the right to undertake technical changes of its products without further notification which could lead to changes in the provided data. LEDiL Oy assumes no liability of any kind for the possible deviation from any provided data or any other damage resulting from the usage of the provided data.

The user agrees to this disclaimer and user agreement with the download or usage of the provided files.

#### LEDiL Oy

Joensuunkatu 13  
FI-24240 SALO  
Finland

#### LEDiL Inc.

228 West Page Street  
Suite D  
Sycamore IL 60178  
USA

#### Ledil Optics Technology (Shenzhen) Co., Ltd.

# 405 , Block B  
Casic Motor Building  
Shenzhen 518057  
P.R.CHINA

#### Local sales and technical support

[www.ledil.com/  
where\\_to\\_buy](http://www.ledil.com/where_to_buy)

#### Shipping locations

Salo, Finland  
Hong Kong, China

#### Distribution Partners

[www.ledil.com/  
where\\_to\\_buy](http://www.ledil.com/where_to_buy)