

CUSTOMER PRINT

PART NUMBER: 8380-XSG-5XX

- NOTES:
 1. ALL PARTS TO BE BULK PACKED
 2. CONTACTS ARE SHIPPED UNASSEMBLED
 3. ALL DIMENSIONS ARE REFERENCE EXCEPT THOSE WITH A TOLERANCE

KIT P/N	GROMMET SIZE
8380-XSG-513	.148 GROMMET I.D. FOR CABLE O.D. .13-.15 [3.3-3.8mm]
8380-XSG-516	.176 GROMMET I.D. FOR CABLE O.D. .16-.18 [4.1-4.6mm]
8380-XSG-519	.206 GROMMET I.D. FOR CABLE O.D. .19-.21 [4.8-5.3mm]
8380-XSG-522	.245 GROMMET I.D. FOR CABLE O.D. .22-.25 [5.6-6.3mm]
8380-XSG-526	.265 GROMMET I.D. FOR CABLE O.D. .25-.27 [6.4-6.9mm]
8380-XSG-528	.280 GROMMET I.D. FOR CABLE O.D. .26-.285 [6.6-7.2mm]

KIT P/N	NO. OF CONTACTS
8380-2SG-5XX	2 #16
8380-3SG-5XX	3 #16
8380-4SG-5XX	4 #16
8380-XSG-5XX	

GROMMET SIZE
 NO. OF CONTACTS

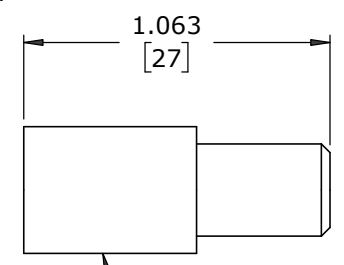
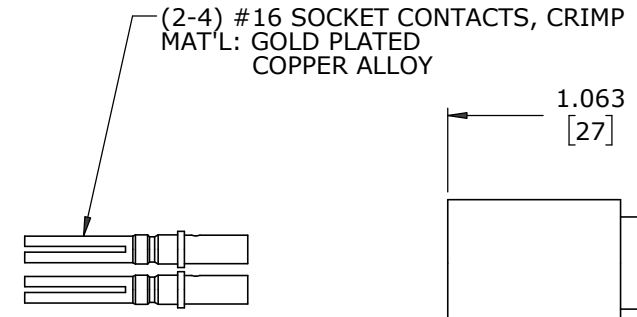
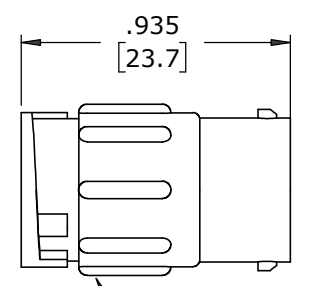
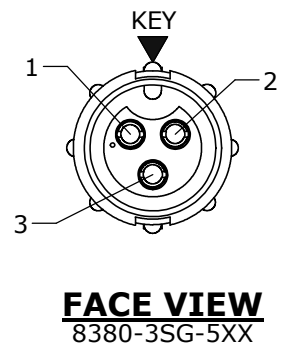
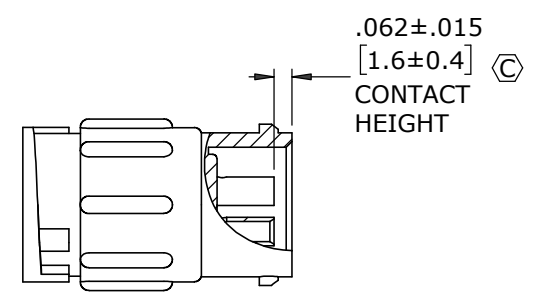
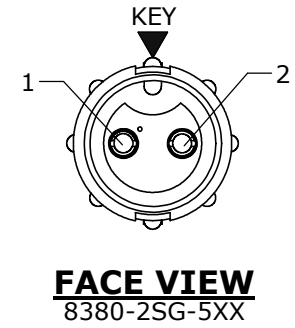

GROMMET
MAT'L: SANTOPRENE, BLACK

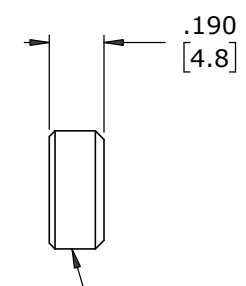

CABLE GRIP
MAT'L: POLYPROPYLENE, BLACK

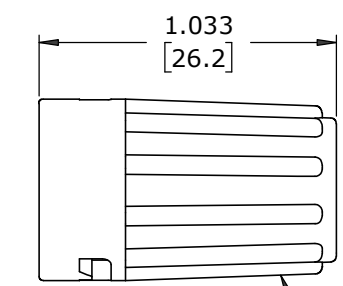

BACKSHELL
MAT'L: NYLON, BLACK

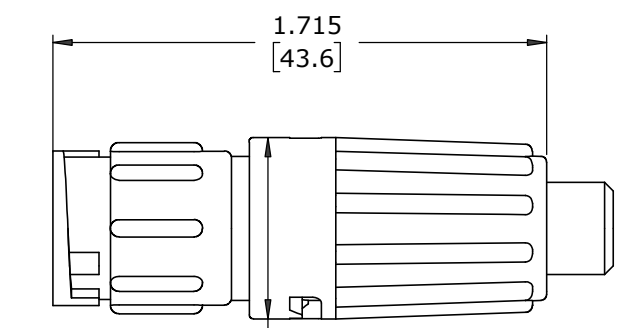
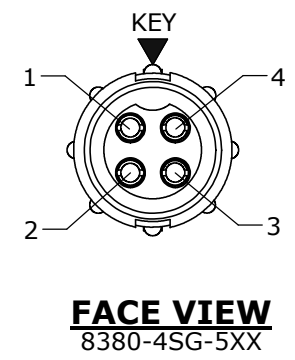

ASSEMBLED VIEW
FOR CUSTOMER REF.

DIMENSIONS IN BRACKETS [] ARE IN MILLIMETERS

CUSTOMER APPROVAL

THIS DOCUMENT CONTAINS CONFIDENTIAL INFORMATION PROPRIETARY TO CONXALL CORPORATION. ANY REPRODUCTION, DISCLOSURE, OR USE OF THIS DOCUMENT /INFORMATION IS EXPRESSLY PROHIBITED UNLESS AUTHORIZED IN WRITING BY CONXALL CORPORATION.

APPROVED BY: _____
 DATE: _____

RoHS COMPLIANT

REV.	INIT.	DATE	DESCRIPTION
C	MA	02-16-21	ADDED 8380-XSG-526 TO CHART & CONTACT HEIGHT VIEW PER ECR 9544
B	PAK	01-14-13	ADDED P/N 8380-XSG-528 FOR .280 CABLE DIA. PER DOR 12-5009TC
A	AN	08-02-12	DRAWING CREATED PER DOR 12-E149SL #20

ALL INFORMATION ILLUSTRATED IS THE PROPERTY OF CONXALL CORPORATION. UNAUTHORIZED DUPLICATION OR DISTRIBUTION OF THIS DOCUMENT IS PROHIBITED.	ORIG. DRAWN BY: AN DATE: 07-30-12	 601 E. WILDWOOD VILLA PARK, IL 60181
ALL UNITS ARE IN FEET, INCHES, FRACTION OF INCHES AND DECIMALS.	CHECKED BY:	
	APPROVED BY:	TITLE: CABLE TO CABLE CONNECTOR KIT (2-4) #16 SOCKET CONTACTS MINI-CON-X
	SCALE: NTS SIZE: B SHEET: 1 OF 1	CUSTOMER: STANDARD PRODUCT
	FILE: 08-02-12 DIRECTORY: SLW	PART NUMBER: 8380-XSG-5XX

REV c