

# WCL2520

## Wire wound chip inductor



### Product features

- 1008 (2520 metric) package
- High Q value
- Tight inductance tolerance
- Inductance range from 0.12  $\mu$ H to 220  $\mu$ H
- Moisture sensitivity level (MSL): 1

### Applications

- Industrial connectivity (IoT)
- Computing/gaming consoles
- Smart meters
- Industrial equipment
- Machine-to-machine (M2M)
- Mobile phones
- Wearable devices
- Wireless LAN
- Wireless communications
  - Bluetooth
  - WiFi
  - Antenna
- RF transceiver modules

### Environmental data

- Operating temperature range: -40 °C to +85 °C
- Solder reflow temperature:  
J-STD-020 (latest revision) compliant



Product specifications

Part number	OCL (uH) ±5%	I Rated (mA) maximum	OCL Test frequency (MHz)	Test voltage (mV)	DCR (Ω) maximum @ +25°C	SRF (MHz) minimum	Q minimum	Q Test frequency (MHz)
WCL2520-R120-R	0.12	800	25.2	500	0.15	850	12	25.2
WCL2520-R390-R	0.39	600	25.2	500	0.29	480	12	25.2
WCL2520-R560-R	0.56	600	25.2	500	0.42	330	12	25.2
WCL2520-R680-R	0.68	600	25.2	500	0.45	330	12	25.2
WCL2520-R820-R	0.82	600	25.2	500	0.62	300	12	25.2
WCL2520-1R0-R	1.0	580	25.2	500	0.55	300	12	25.2
WCL2520-1R2-R	1.2	550	7.96	500	0.75	250	12	7.96
WCL2520-1R5-R	1.5	400	7.96	500	0.85	230	12	7.96
WCL2520-1R8-R	1.8	320	7.96	500	0.95	168	12	7.96
WCL2520-2R2-R	2.2	315	7.96	500	1.3	150	12	7.96
WCL2520-2R7-R	2.7	300	7.96	500	1.4	100	12	7.96
WCL2520-3R3-R	3.3	280	7.96	500	1.5	80	12	7.96
WCL2520-3R9-R	3.9	250	7.96	500	1.55	60	12	7.96
WCL2520-4R7-R	4.7	210	7.96	500	1.72	50	12	7.96
WCL2520-5R6-R	5.6	190	7.96	500	1.9	40	12	7.96
WCL2520-6R8-R	6.8	175	7.96	500	2.0	35	12	7.96
WCL2520-8R2-R	8.2	160	7.96	500	2.2	25	12	7.96
WCL2520-100-R	10	155	2.52	500	2.5	25	10	2.52
WCL2520-120-R	12	145	2.52	500	2.6	20	10	2.52
WCL2520-150-R	15	130	2.52	500	3.0	20	10	2.52
WCL2520-180-R	18	130	2.52	500	3.0	20	10	2.52
WCL2520-220-R	22	105	2.52	500	3.9	18	10	2.52
WCL2520-270-R	27	100	2.52	500	4.0	10	10	2.52
WCL2520-330-R	33	85	2.52	500	4.8	8	10	2.52
WCL2520-390-R	39	80	2.52	500	5.0	7	10	2.52
WCL2520-470-R	47	60	2.52	500	5.7	7	10	2.52
WCL2520-560-R	56	55	2.52	500	6.0	6.5	10	2.52
WCL2520-680-R	68	50	2.52	500	6.7	6.5	10	2.52
WCL2520-820-R	82	45	2.52	500	7.5	6.5	10	2.52
WCL2520-101-R	100	40	0.796	500	11	4.5	8	0.796
WCL2520-121-R	120	30	0.796	500	13	3	8	0.796
WCL2520-151-R	150	25	0.796	500	15	3	8	0.796
WCL2520-221-R	220	20	0.796	500	18	2.5	8	0.796

1. Test frequency and voltage at +25 °C. Test voltage is for both OCL and Q.
2. Resistance to soldering heat: +260 ±5 °C for 10 ± 1 second
3. At low temperature resistance (-40 ±2°C) the inductance change is within ±5% and the Q within ±10%
4. At high temperature resistance (+85 ±5°C) the inductance change is within ±5% and the Q within ±10%
5. At high temperature load (+85 ±2°C) the inductance change is within ±5% and the Q within ±10%

6. Insulation Resistance: ≥ 500 MΩ with an input voltage of 100 V ±15 Vdc
7. Temperature Characteristics: From -40 °C to +85 °C the inductance is within ±5%
8. Rated I: When rated I is applied to the product, self-temperature rise will be 20 °C or less.
9. Part Number Definition: WCL2520-xxx-R  
 WCL2520 = Product code and size  
 xxx= inductance value in uH, R= decimal point,  
 If no R is present then last character equals number of zeros  
 -R suffix = RoHS compliant

**Dimensions (mm)**

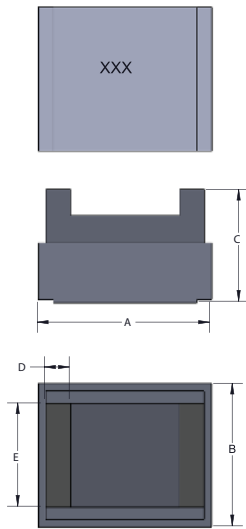

Recommended pad layout

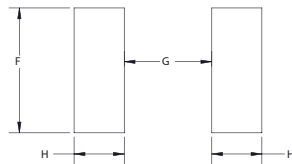

Schematic

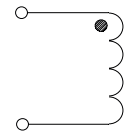

Part Number	A	B	C	D	E	F	G	H
WCL2520-xxx-R	2.92 max	2.79 max	2.10 max	0.50 ref	2.0 ref	2.54	1.27	1.02

Part marking: xxx= Inductance value in uH, R=decimal point. If no R is present then last character equals number of zeros  
 All soldering surfaces to be coplanar within 0.1 millimeters  
 Tolerances are ±0.2 millimeters unless stated otherwise  
 Pad layout tolerances are ±0.1 millimeters unless stated otherwise  
 Do not route traces or vias underneath the inductor

**Packaging information (mm)**

Drawing not to scale

Supplied in tape and reel packaging, 2000 parts per 7" diameter reel

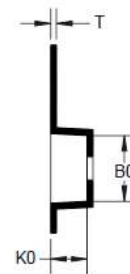
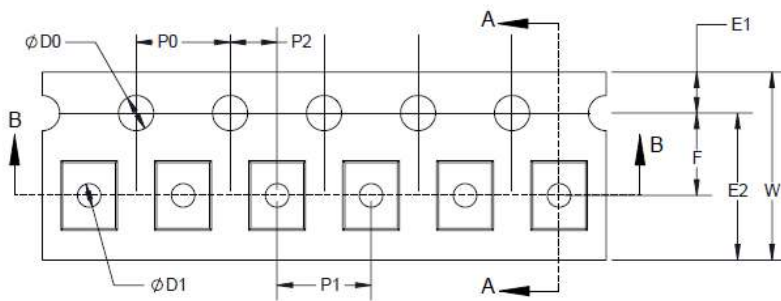

SECTION A-A

W ±0.30	8.00
F ±0.05	3.50
E1 ±0.10	1.75
E2 Min	6.25
P0 ±0.10	4.00
P1 ±0.10	4.00
P2 ±0.05	2.00
D0 +0.10/-0	1.50
D1 +0.10/-0	0.65
A0	2.73 ±0.05
B0	2.9 ±0.10
K0	2.34 ±0.10
T Max	0.25



SECTION B-B

### Inductance vs frequency

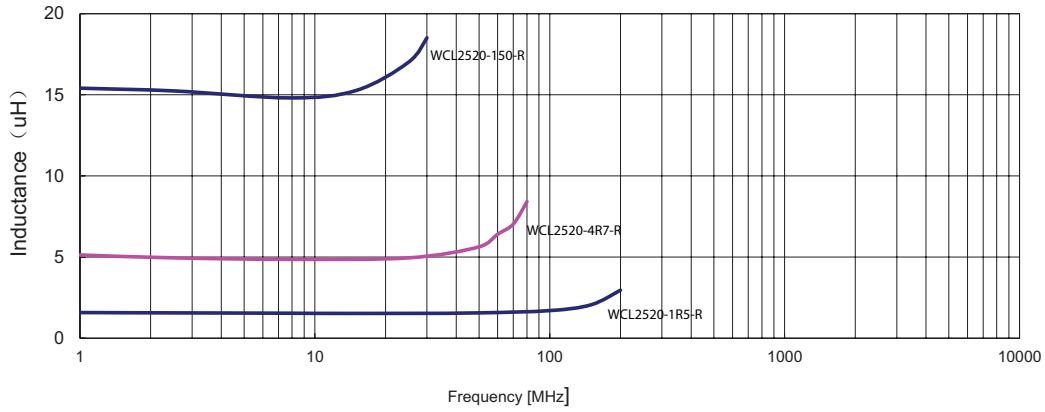

### Q vs frequency

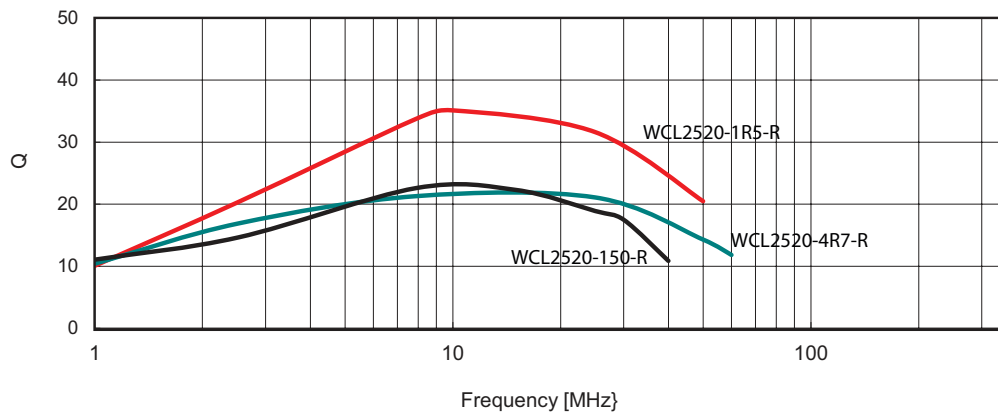

Solder reflow profile

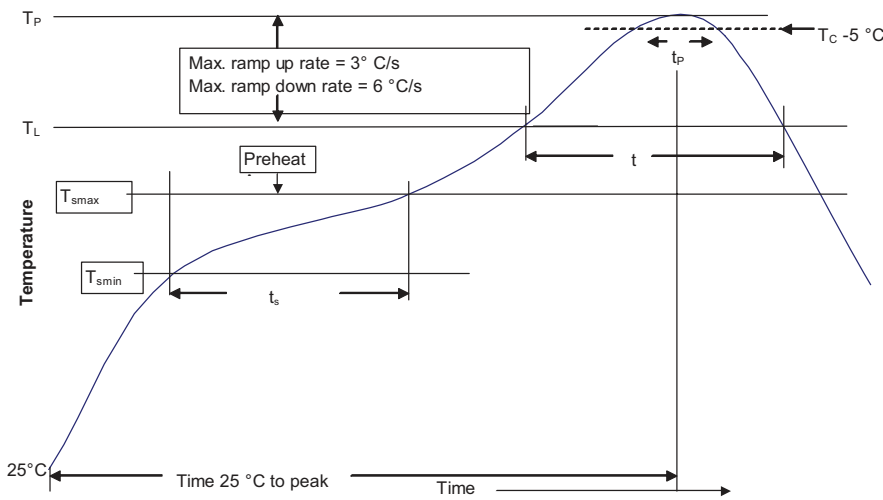

Table 1 - Standard SnPb solder ( $T_C$ )

Package Thickness	Volume mm <sup>3</sup> <350	Volume mm <sup>3</sup> ≥350
<2.5 mm)	235 °C	220 °C
≥2.5 mm	220 °C	220 °C

Table 2 - Lead (Pb) free solder ( $T_C$ )

Package thickness	Volume mm <sup>3</sup> <350	Volume mm <sup>3</sup> 350 - 2000	Volume mm <sup>3</sup> >2000
<1.6 mm	260 °C	260 °C	260 °C
1.6 – 2.5 mm	260 °C	250 °C	245 °C
>2.5 mm	250 °C	245 °C	245 °C

Reference J-STD-020

Profile feature	Standard SnPb solder	Lead (Pb) free solder
Preheat and soak		
• Temperature min. ( $T_{smin}$ )	100 °C	150 °C
• Temperature max. ( $T_{smax}$ )	150 °C	200 °C
• Time ( $T_{smin}$ to $T_{smax}$ ) ( $t_s$ )	60-120 seconds	60-120 seconds
Average ramp up rate $T_{smax}$ to $T_p$	3 °C/ second max.	3 °C/ second max.
Liquidous temperature ( $T_L$ )	183 °C	217 °C
Time at liquidous ( $t_L$ )	60-150 seconds	60-150 seconds
Peak package body temperature ( $T_p$ )*	Table 1	Table 2
Time ( $t_p$ )** within 5 °C of the specified classification temperature ( $T_C$ )	10 seconds**	10 seconds**
Average ramp-down rate ( $T_p$ to $T_{smax}$ )	6 °C/ second max.	6 °C/ second max.
Time 25 °C to peak temperature	6 minutes max.	8 minutes max.

\* Tolerance for peak profile temperature ( $T_p$ ) is defined as a supplier minimum and a user maximum.  
\*\* Tolerance for time at peak profile temperature ( $t_p$ ) is defined as a supplier minimum and a user maximum.

Life Support Policy: Eaton does not authorize the use of any of its products for use in life support devices or systems without the express written approval of an officer of the Company. Life support systems are devices which support or sustain life, and whose failure to perform, when properly used in accordance with instructions for use provided in the labeling, can be reasonably expected to result in significant injury to the user.

Eaton reserves the right, without notice, to change design or construction of any products and to discontinue or limit distribution of any products. Eaton also reserves the right to change or update, without notice, any technical information contained in this bulletin.

**Eaton**  
Electronics Division  
1000 Eaton Boulevard  
Cleveland, OH 44122  
United States  
www.eaton.com/electronics

© 2019 Eaton  
All Rights Reserved  
Printed in USA  
Publication No. 10930 BU-MC19062  
July 2019

Eaton is a registered trademark.  
All other trademarks are property of their respective owners.

Follow us on social media to get the latest product and support information.

