

# SD2420

## Silicon Photodiode

### FEATURES

- Miniature, hermetically sealed, pill style, metal can package
- 48° (nominal) acceptance angle
- Wide operating temperature range (- 55°C to +125°C)
- Ideal for direct mounting to printed circuit boards
- Mechanically and spectrally matched to SE2460 and SE2470 infrared emitting diodes

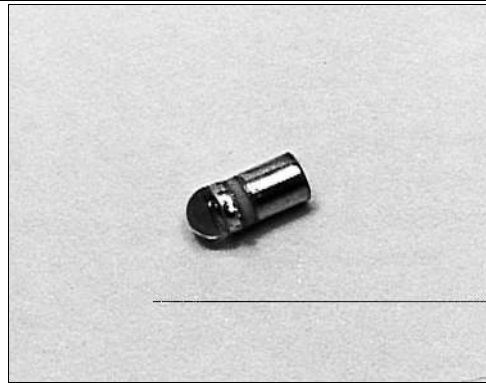

INFRA-1.TIF

### DESCRIPTION

The SD2420 is a PN silicon photodiode mounted in a hermetically sealed, glass lensed, metal can package. This package directly mounts in double sided PC boards.

### OUTLINE DIMENSIONS in inches (mm)

Tolerance 3 plc decimals ±0.005(0.12)  
2 plc decimals ±0.020(0.51)

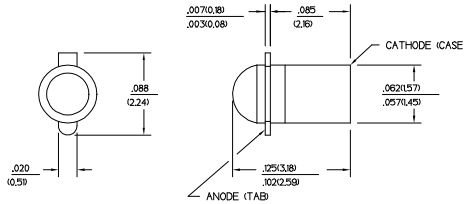

DIM\_014.cdr

# SD2420

## Silicon Photodiode

### ELECTRICAL CHARACTERISTICS (25°C unless otherwise noted)

PARAMETER	SYMBOL	MIN	TYP	MAX	UNITS	TEST CONDITIONS
Light Current SD2420-002	$I_L$	7.0			$\mu\text{A}$	$V_R=20\text{ V}$ $H=20\text{ mW/cm}^2$ (1)
Dark Current	$I_D$			5.0	nA	$V_R=20\text{ V}$ $H=0$
Reverse Breakdown Voltage	$V_{BR}$	50			V	$I_R=10\ \mu\text{A}$
Angular Response (2)	$\emptyset$		48		degr.	$I_F=\text{Constant}$
Rise And Fall Time	$t_r, t_f$		50		ns	$V_R=20\text{ V}$ $R_L=50\ \Omega$

#### Notes

1. The radiation source is a tungsten lamp operating at a color temperature of 2870°K.
2. Angular response is defined as the total included angle between the half sensitivity points.

### ABSOLUTE MAXIMUM RATINGS

(25°C Free-Air Temperature unless otherwise noted)

Cathode Anode Voltage	50 V
Power Dissipation	125 mW (1)
Operating Temperature Range	-55°C to 125°C
Storage Temperature Range	-65°C to 150°C
Soldering Temperature (10 sec)	260°C

#### Notes

1. Derate linearly from 25°C free-air temperature at the rate of 1.19 mW/°C.

### SCHEMATIC

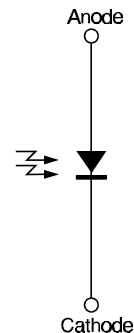

Honeywell reserves the right to make changes in order to improve design and supply the best products possible.

# Honeywell

# SD2420

## Silicon Photodiode

SWITCHING TIME TEST CIRCUIT

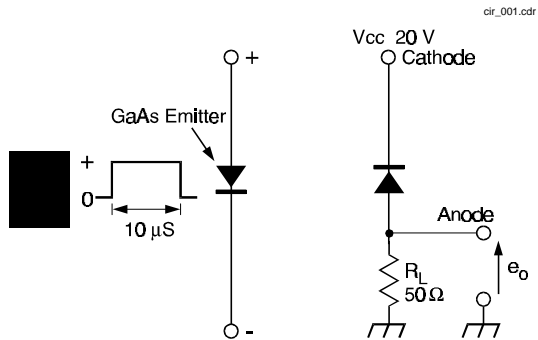

Fig. 1 Responsivity vs Angular Displacement

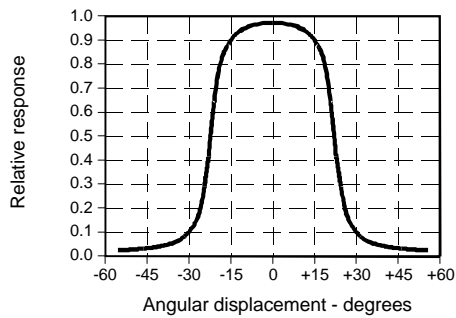
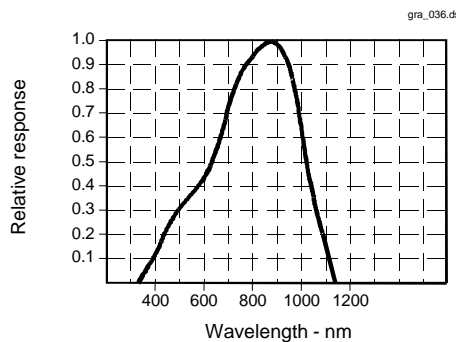

Fig. 3 Spectral Responsivity



All Performance Curves Show Typical Values

SWITCHING WAVEFORM

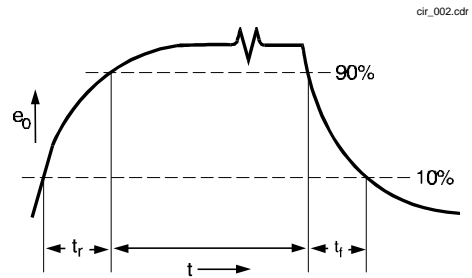
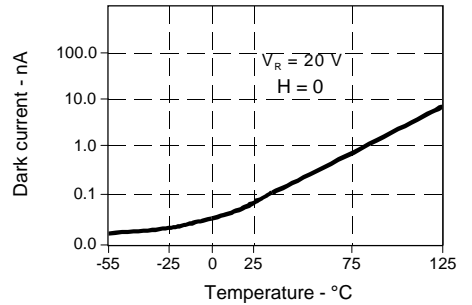

Fig. 2 Dark Current vs Temperature



**SD2420**  
Silicon Photodiode

---



Honeywell reserves the right to make changes in order to improve design and supply the best products possible.

**Honeywell**