

11.35-Gbps Differential Modulator Driver with Output Waveform Shaping

Check for Samples: [ONET1151M](#)

FEATURES

- 1.5- V_{PP} Single-Ended Output Voltage into a 50- Ω Load
- Programmable Input Equalizer
- Output Pre-emphasis
- Adjustable Rise and Fall Times
- Cross-Point Control
- Output Polarity Select
- 2-Wire Digital Interface
- Single 3.3-V Supply

- -40°C to 100°C Operation
- Surface Mount 3-mm x 3-mm 16-Pin RoHS Compliant QFN Package

APPLICATIONS

- SONET OC-192/SDH STM-64 Optical Transmitters
- 10-Gigabit Ethernet Optical Transmitters
- SFP+ and XFP Transceiver Modules

DESCRIPTION

The ONET1151M is a high-speed, 3.3-V modulator driver designed to modulate a differentially driven Mach Zehnder Modulator at data rates from 1 Gbps up to 11.35 Gbps.

The output amplitude can be controlled with an externally applied voltage. A 2-wire serial interface allows digital control of the equalizer, output pre-emphasis, eye crossing point, rise and fall times, and the amplitude, eliminating the need for external components. Output waveform control, in the form of pre-emphasis, cross-point adjustment and rise and fall time adjustment are available to improve the optical eye mask margin.

An optional input equalizer with 10 dB of boost at 5 GHz can be used for equalization of up to 300-mm (12 in.) of microstrip or stripline transmission line on FR4 printed circuit boards.

The modulator driver is characterized for operation from -40°C to 100°C case temperature and is available in a small footprint 3-mm x 3-mm 16-pin RoHS compliant QFN package.



Please be aware that an important notice concerning availability, standard warranty, and use in critical applications of Texas Instruments semiconductor products and disclaimers thereto appears at the end of this data sheet.

I^2C is a trademark of Philips Semiconductor Inc.

PRODUCTION DATA information is current as of publication date. Products conform to specifications per the terms of the Texas Instruments standard warranty. Production processing does not necessarily include testing of all parameters.

Copyright © 2012, Texas Instruments Incorporated



This integrated circuit can be damaged by ESD. Texas Instruments recommends that all integrated circuits be handled with appropriate precautions. Failure to observe proper handling and installation procedures can cause damage.

ESD damage can range from subtle performance degradation to complete device failure. Precision integrated circuits may be more susceptible to damage because very small parametric changes could cause the device not to meet its published specifications.

BLOCK DIAGRAM

Figure 1 shows a simplified block diagram of the ONET1151M. The modulator driver consists of an equalizer, a limiter, an output driver, power-on reset circuitry, a 2-wire serial interface including a control logic block, a modulation current generator, and an analog reference block.

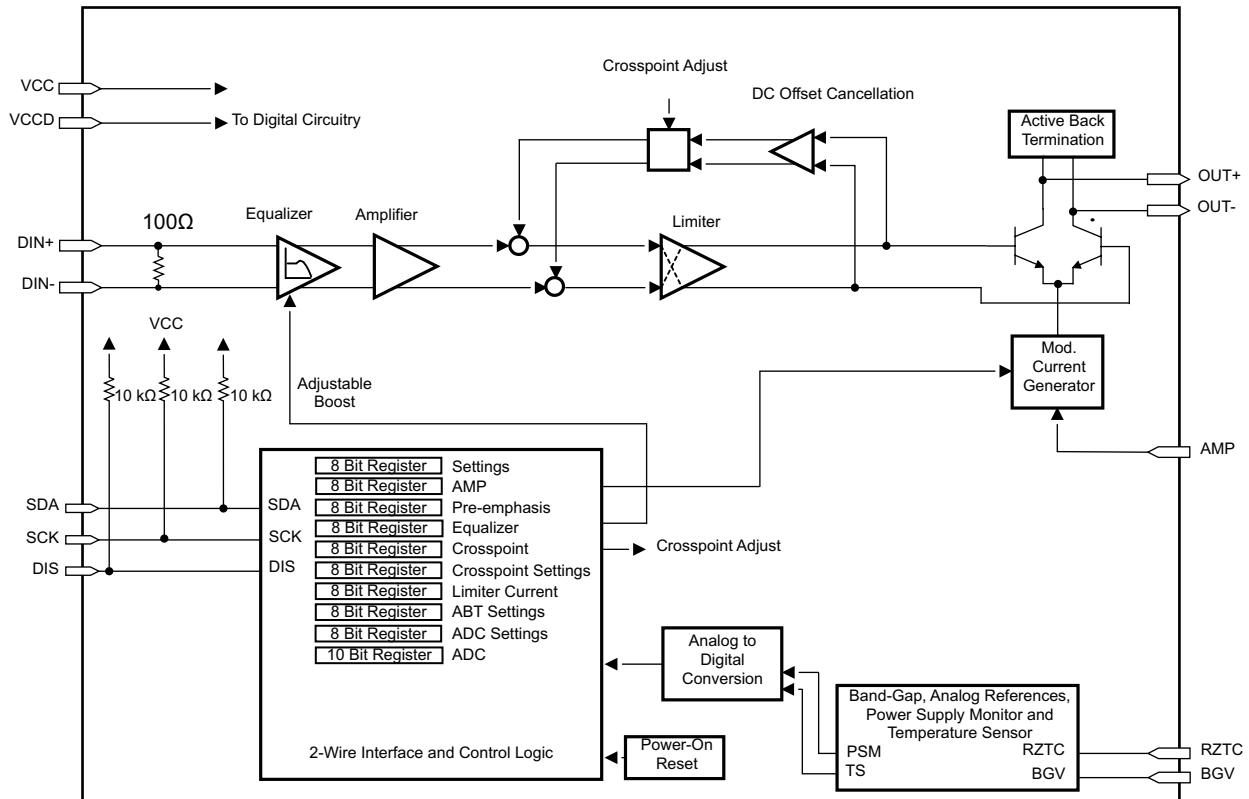

Figure 1. Simplified Block Diagram of the ONET1151M

PACKAGE

The ONET1151M is packaged in a small footprint 3-mm × 3-mm 16-pin RoHS compliant QFN package with a lead pitch of 0.5 mm.

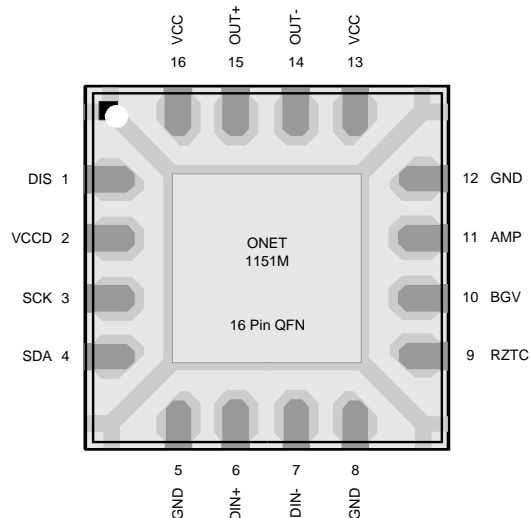

Figure 2. 16-Pin QFN Package, 3-mm x 3-mm (Top View)

Table 1. PIN DESCRIPTIONS

PIN		TYPE	DESCRIPTION
NAME	NO.		
DIS	1	Digital-in	Disables bias, modulation, and peaking currents when set to high state. Includes a 10-kΩ or 40-kΩ pullup resistor to VCC.
VCCD	2	Supply	3.3 V ± 10% supply voltage for the digital logic. Connect to VCC.
SCK	3	Digital-in	2-wire interface serial clock. Includes a 10-kΩ or 40-kΩ pullup resistor to VCC.
SDA	4	Digital-in/out	2-wire interface serial data input. Includes a 10-kΩ or 40-kΩ pullup resistor to VCC.
GND	5, 8, 12	Supply	Circuit ground
DIN+	6	Analog-in	Non-inverted data input. On-chip differentially 100-Ω terminated to DIN-. Must be AC coupled.
DIN-	7	Analog-in	Inverted data input. On-chip differentially 100-Ω terminated to DIN+. Must be AC coupled.
RZTC	9	Analog	Connect external zero TC 28.7-kΩ resistor to ground (GND). Used to generate a defined zero TC reference current for internal DACs.
BGV	10	Analog-out	Buffered bandgap voltage with 1.16-V output. This is a replica of the bandgap voltage at RZTC.
AMP	11	Analog-in	Output amplitude control. Output amplitude can be adjusted by applying a voltage of 0 to 2.5 V to this pin.
VCC	13, 16	Supply	3.3 V ± 10% supply voltage. Connect to VCCD.
OUT-	14	CML-out (current)	Inverted data output
OUT+	15	CML-out (current)	Non-inverted data output
EP	EP	Thermal	Exposed die pad (EP) must be grounded.

ABSOLUTE MAXIMUM RATINGS⁽¹⁾

over operating free-air temperature range (unless otherwise noted)

PARAMETER		VALUE		UNIT
		MIN	MAX	
V_{CC}	Supply voltage ⁽²⁾	-0.3	4	V
V_{DIS} , V_{RZTC} , V_{SCK} , V_{SDA} , V_{BGV} , V_{AMP} , V_{DIN+} , V_{DIN-} , V_{OUT+} , V_{OUT-}	Voltage at DIS, RZTC, SCK, SDA, BGV, AMP, DIN+, DIN-, OUT+, OUT- ⁽²⁾	-0.3	4	V
I_{DIN-} , I_{DIN+}	Max. current at input pins		25	mA
I_{MOD+} , I_{MOD-}	Max. current at output pins		35	mA
ESD	ESD rating at all pins except OUT+ and OUT-		2	kV (HBM)
	ESD rating at OUT+ and OUT-		1.5	kV (HBM)
$T_{J, max}$	Maximum junction temperature		125	°C
T_{STG}	Storage temperature range	-65	150	°C
T_C	Case temperature	-40	110	°C

- (1) Stresses beyond those listed under *Absolute Maximum Ratings* may cause permanent damage to the device. These are stress ratings only, and functional operation of the device at these or any other conditions beyond those indicated under *Recommended Operating Conditions* is not implied. Exposure to absolute–maximum–rated conditions for extended periods may affect device reliability.
- (2) All voltage values are with respect to network ground terminal.

RECOMMENDED OPERATING CONDITIONS

over operating free-air temperature range (unless otherwise noted)

PARAMETER	CONDITION	VALUE			UNIT
		MIN	TYP	MAX	
V_{CC}	Supply voltage	2.97	3.3	3.63	V
V_{IH}	Digital input high voltage	2			V
V_{IL}	Digital input low voltage	0.8			V
R_{RZTC}	Zero TC resistor value ⁽¹⁾	28.4	28.7	29	k Ω
V_{IN}	Differential input voltage swing	150		1200	mV _{p-p}
V_{AMP}	Amplitude control input voltage range	0		2.5	V
t_{R-IN}	Input rise time	20%–80%		30	ps
t_{F-IN}	Input fall time	20%–80%		30	ps
T_C	Temperature at thermal pad	-40		100	°C

- (1) Changing the value alters the DAC ranges and the current consumption.

DC ELECTRICAL CHARACTERISTICS

over recommended operating conditions with 50-Ω output load, $V_{OUT+} = 1.5 V_{PP}$ and $R_{RZTC} = 28.7 \text{ k}\Omega$, unless otherwise noted. Typical operating condition is at 3.3 V and $T_A = 25^\circ\text{C}$

PARAMETER	CONDITION	VALUE			UNIT			
		MIN	TYP	MAX				
V_{CC}	Supply voltage	2.97	3.3	3.63	V			
I_{VCC}	Supply current	$V_{CC} = 3.47 \text{ V}$, PKENA = 1			100	mA		
		$V_{CC} = 3.63 \text{ V}$, PKENA = 1			105			
P	Power Dissipation	$V_{CC} = 3.47 \text{ V}$, PKENA = 1			347	mW		
		$V_{CC} = 3.63 \text{ V}$, PKENA = 1			381			
R_{IN}	Data input resistance	Differential between DIN+ / DIN-			80	100	120	Ω
I_{IH}	High level digital input current	SCK, SDA, DIS set to V_{CC} ⁽¹⁾			-10		10	μA
I_{IL}	Low level digital input current	SCK, SDA, DIS set to GND ⁽¹⁾			-500		500	μA
V_{CC-RST}	V_{CC} reset threshold voltage	V_{CC} voltage level which triggers power-on reset			2.3	2.5	2.8	V
$V_{CC-RSTHYS}$	V_{CC} reset threshold voltage hysteresis					100		mV

(1) Assured by simulation over process, supply and temperature variation

AC ELECTRICAL CHARACTERISTICS

over recommended operating conditions with 50-Ω output load, $V_{OUT+} = 1.5 V_{PP}$ and $R_{RZTC} = 28.7 \text{ k}\Omega$ unless otherwise noted. Typical operating condition is at $V_{CC} = 3.3 \text{ V}$ and $T_A = 25^\circ\text{C}$.

PARAMETER	CONDITION	VALUE			UNIT		
		MIN	TYP	MAX			
	Data rate			11.35	Gbps		
SDD11	Differential input return gain	0.01 GHz < f < 5 GHz			-15	dB	
		5 GHz < f < 11.1 GHz			-8		
SCD11	Differential to common mode conversion gain	0.01 GHz < f < 11.1 GHz			-15	dB	
V_{O-MIN}	Minimum output amplitude	50-Ω load, single-ended				300	mV_{PP}
V_{O-MAX}	Maximum output amplitude	50-Ω load, single-ended, OASH0 = OASH1 = 0			1.4		V_{PP}
	Output amplitude stability	50-Ω load, single-ended				200	mV
t_{R-OUT}	Output rise time	20% – 80%, $t_{R-IN} < 40 \text{ ps}$, 50-Ω load, single-ended, cross point = 50%. ⁽¹⁾			26	36	ps
t_{F-OUT}	Output fall time	20% – 80%, $t_{F-IN} < 40 \text{ ps}$, 50-Ω load, single-ended, cross point = 50%. ⁽¹⁾			26	36	ps
ISI	Intersymbol interference ⁽²⁾	EQENA = 0, K28.5 pattern at 11.35 Gbps, 150-mV _{PP} , 600-mV _{PP} , 1200-mV _{PP} differential input voltage, single-ended output. 750 mV _{PP} ≤ V_{OUT} ≤ 1.5 V _{PP}			5	10	ps _{p-p}
		EQENA = 1, K28.5 pattern at 11.35 Gbps with 12-inch transmission line at the input, 150-mV _{PP} , 600-mV _{PP} , 1200-mV _{PP} input to transmission line, single-ended output. 750 mV _{PP} ≤ V_{OUT} ≤ 1.5 V _{PP} .			6		
RJ	Random output jitter	EQENA = 0			0.3	0.6	ps _{RMS}
	High cross point control range	50-Ω load, single-ended			75		%
	Low cross point control range	50-Ω load, single-ended			25		%

(1) 1010 pattern with PKENA = 1 and PEADJ (Register 2) set to 0x0F.

(2) Jitter at the eye crossing point.

AC ELECTRICAL CHARACTERISTICS (continued)

over recommended operating conditions with 50-Ω output load, $V_{OUT+} = 1.5 V_{PP}$ and $R_{RZTC} = 28.7 \text{ k}\Omega$ unless otherwise noted. Typical operating condition is at $V_{CC} = 3.3 \text{ V}$ and $T_A = 25^\circ\text{C}$.

PARAMETER	CONDITION	VALUE			UNIT
		MIN	TYP	MAX	
Cross point stability	50-Ω load, single-ended, $V_{IN} = 180 \text{ mV}_{PP}$, 600 mV_{PP} and 1200 mV_{PP} , $V_{OUT} = 1.2 V_{PP}$		±5		pp
Cross point stability vs. input amplitude	50-Ω load, single-ended, $V_{IN} = 180 \text{ mV}_{PP}$, 600 mV_{PP} and 1200 mV_{PP} , $V_{OUT} = 1.2 V_{PP}$	-6		6	pp
BW_{AMP} Bandwidth of AMP input			2.5		kHz
T_{OFF} Transmitter disable time	Rising edge of DIS to $V_{OUT+} \leq 0.15 V_{PP}$ ⁽³⁾		0.05	5	μs
T_{ON} Disable negate time	Falling edge of DIS to $V_{OUT+} \geq 1.2 V_{PP}$ ⁽³⁾			1	ms
T_{INIT1} Power-on to initialize	Power-on to registers ready to be loaded ⁽³⁾		1	10	ms
T_{INIT2} Initialize to transmit	Register load STOP command to part ready to transmit valid data ⁽³⁾			2	ms

(3) Assured by simulation over process, supply, and temperature variation.

DETAILED DESCRIPTION

EQUALIZER

The data signal is applied to an input equalizer by means of the input signal pins DIN+ / DIN–, which provide on-chip differential 100-Ω line-termination. The equalizer is enabled by setting EQENA to 1 (bit 1 of register 0). Equalization of up to 300-mm (12 in.) of microstrip or stripline transmission line on FR4 printed circuit boards can be achieved. The amount of equalization is digitally controlled by the 2-wire interface and control logic block and is dependant on the register settings EQADJ[0..7] (register 3). The equalizer can be turned off and bypassed by setting EQENA to 0. For details about the equalizer settings, see [Table 16](#).

LIMITER

By limiting the output signal of the equalizer to a fixed value, the limiter removes any overshoot after the input equalization and provides the input signal for the output driver. Adjustments to the limiter bias current and emitter follower current can be made to trade off the rise and fall times and supply current. The limiter bias current is adjusted through LIMCSGN (bit 7 of register 6) and LIMC[0..2] (bits 4, 5 and 6 of register 6). The emitter follower current is adjusted through EFCSGN (bit 3 of register 6) and EFC[0..2] (bits 0, 1 and 2 of register 6). In addition, the slope of the emitter follower current can be modified with the EFCRNG bit (bit 3 of register 5). Setting EFCRNG to 1 results in a steeper slope.

HIGH-SPEED OUTPUT DRIVER

The modulation current is sunk from the common emitter node of the limiting output driver differential pair by means of a modulation current generator, which is digitally controlled by the 2-wire serial interface. The collector nodes of the output stages are connected to the output pins OUT+ and OUT–. The collectors have internal active back termination. The outputs are optimized to drive a 50-Ω single-ended load and to obtain the maximum single-ended output voltage of 1.5 V_{PP}. AC coupling and inductive pullups to VCC are required. The active back termination emitter follower current is adjusted through ABTSGN (bit 3 of register 7) and ABTEF[0..2] (bits 0, 1 and 2 of register 7). ABTUP (bit 7 of register 7) and ABTDWN (bit 6 of register 7) can control the active back termination auxiliary buffer amplitude. Setting ABTUP to 1 increases the amplitude and setting ABTDWN to 1 decreases the amplitude. For most instances, these settings may be left in the default mode.

For waveform shaping, output pre-emphasis can be enabled by setting PKENA to 1 (bit 5 of register 0) and adjusting the peaking height through PEADJ[0..3] (register 2).

In addition, the polarity of the output pins can be inverted by setting the output polarity switch bit, POL (bit 2 of register 0) to 1.

MODULATION CURRENT GENERATOR

The modulation current generator provides the current for the current modulator described above. The modulation current generator is controlled by applying an analog voltage in the range of 0 to 2.5 V to the AMP pin, or it can be digitally controlled by the 2-wire interface block. The default method of control is through the AMP pin. To digitally control the output amplitude set AMPCTRL (bit 0 of register 0) to 1.

An 8-bit wide control bus, AMP[0..7] (register 1), can be used to set the desired modulation current, and therefore, the output voltage.

To decrease the output amplitude by approximately 18% set OARNG to 1 (bit 7 of register 5), to increase it by approximately 30 mV_{PP} set OASH0 (bit 5 of register 5) to 1, or to increase it by approximately 60 mV_{PP} set OASH1 (bit 6 of register 5) to 1.

The modulation current, and therefore the output signal, can be disabled by setting the DIS input pin to a high level or by setting ENA to 0 (bit 7 of register 0).

DC OFFSET CANCELLATION AND CROSS POINT CONTROL

The ONET1151M has DC offset cancellation to compensate for internal offset voltages. The offset cancellation can be disabled and the eye crossing point adjustment enabled by setting CPENA to 1 (bit 3 of register 0). The crossing point can be moved toward the one level by setting CPSGN to 0 (bit 7 of register 4) and it can be moved toward the zero level by setting CPSGN to 1. The percentage of shift depends upon the register settings CPADJ[0..6] (register 4) and the high cross point adjustment range bits HICP[0..1] (bits 0 and 1 of register 5). Setting HICP0 and HICP1 to 1 results in the maximum adjustment range but increases the supply current.

ANALOG REFERENCE AND TEMPERATURE SENSOR

The ONET1151M modulator driver is supplied by a single 3.3-V \pm 10% supply voltage connected to the VCC and VCCD pins. This voltage is referred to ground (GND) and can be monitored as a 10-bit unsigned digital word through the 2-wire interface.

On-chip bandgap voltage circuitry generates a reference voltage, independent of the supply voltage, from which all other internally required voltages and bias currents are derived.

An external zero temperature coefficient resistor must be connected from the RZTC pin of the device to ground. This resistor is used to generate a precise, zero-TC current which is required as a reference current for the on-chip DACs.

In order to minimize the module component count, the ONET1151M provides an on-chip temperature sensor. The temperature can be monitored as a 10-bit unsigned digital word through the 2-wire interface.

POWER-ON RESET

The ONE1151M has power on reset circuitry which ensures that all registers are reset to zero during startup. After the power-on to initialize time (t_{INIT1}), the internal registers are ready to be loaded. The part is ready to transmit data after the initialize to transmit time (t_{INIT2}), assuming that the chip enable bit ENA is set to 1 and the disable pin DIS is low. The DIS pin has an internal 10-k Ω pullup resistor so the pin must be pulled low to enable the outputs.

The ONET1151M can be disabled using either the ENA control register bit or the disable pin DIS. In both cases the internal registers are not reset. After the disable pin DIS is set low and/or the enable bit ENA is set back to 1, the part returns to its prior output settings.

ANALOG TO DIGITAL CONVERTER

The ONET1151M has an internal 10-bit analog to digital converter (ADC) that converts the analog monitors for temperature and power supply voltage into a 10-bit unsigned digital word. The first eight most significant bits (MSBs) are available in register 14 and the two least significant bits (LSBs) are available in register 15. Depending on the accuracy required, eight bits or 10 bits can be read. However, due to the architecture of the 2-wire interface, in order to read the two registers, two separate read commands have to be sent.

The ADC is enabled by default. To monitor a particular parameter, select the parameter with ADCSEL (bit 0 of register 13). [Table 2](#) lists the ADCSEL bits and the monitored parameters.

Table 2. ADC Selection Bits and the Monitored Parameter

ADCSEL	Monitored Parameter
0	Temperature
1	Supply voltage

If it is not desired to use the ADC to monitor the two parameters then the ADC can be disabled by setting ADCDIS to 1 (bit 7 of register 13) and OSCDIS to 1 (bit 6 of register 13).

The digital word read from the ADC can be converted to its analog equivalent through the following formulas:

Temperature without a mid point calibration:

$$\text{Temperature (}^{\circ}\text{C)} = \frac{(\text{ADCx} - 264)}{6}$$

Temperature with a mid point calibration:

$$\text{Temperature (}^\circ\text{C)} = \frac{(T_cal (^\circ\text{C}) + 273) \times (\text{ADCx} + 1362)}{(\text{ADC_cal} + 1362) - 273}$$

Power supply voltage:

$$\text{Power supply voltage (V)} = \frac{2.25 \times (\text{ADCx} + 1380)}{1409}$$

2-WIRE INTERFACE AND CONTROL LOGIC

The ONET1151M uses a 2-wire serial interface for digital control. For example, the two circuit inputs, SDA and SCK, are respectively driven by the serial data and serial clock from a microprocessor. The SDA and SCK pins have internal 10-k Ω pullups to VCC. If a common interface is used to control multiple parts, the internal pullups can be set to 40 k Ω by setting HITERM to 1 (bit 6 of register 0). The internal pullup for the DIS pin is also set to 40 k Ω when HITERM is set to 1.

The 2-wire interface allows write access to the internal memory map to modify control registers and read access to read out the control signals. The ONET1151M is a slave device only which means that it cannot initiate a transmission itself; it always relies on the availability of the SCK signal for the duration of the transmission. The master device provides the clock signal as well as the START and STOP commands. The protocol for a data transmission is as follows:

1. START command
2. 7-bit slave address (0001000) followed by an eighth bit which is the data direction bit (R/W). A zero indicates a WRITE and a 1 indicates a READ.
3. 8-bit register address
4. 8-bit register data word
5. STOP command

Regarding timing, the ONET1151M is I²C™ compatible. The typical timing is shown in [Figure 3](#) and complete data write and read transfers are shown in [Figure 4](#). Parameters for [Figure 3](#) are defined in [Table 3](#).

Bus Idle: Both SDA and SCK lines remain HIGH.

Start Data Transfer: A START condition (S) is defined by a change in the state of the SDA line from HIGH to LOW while the SCK line is HIGH. Each data transfer is initiated with a START condition.

Stop Data Transfer: A STOP condition (P) is defined by a change in the state of the SDA line from LOW to HIGH while the SCK line is HIGH. Each data transfer is terminated with a STOP condition. However, if the master still wishes to communicate on the bus, it can generate a repeated START condition and address another slave without first generating a STOP condition.

Data Transfer: Only one data byte can be transferred between a START and a STOP condition. The receiver acknowledges the transfer of data.

Acknowledge: Each receiving device, when addressed, is obligated to generate an acknowledge bit. The transmitter releases the SDA line and a device that acknowledges must pull down the SDA line during the acknowledge clock pulse in such a way that the SDA line is stable LOW during the HIGH period of the acknowledge clock pulse. Setup and hold times must be taken into account. When a slave-receiver does not acknowledge the slave address, the data line must be left HIGH by the slave. The master can then generate a STOP condition to abort the transfer. If the slave-receiver does acknowledge the slave address but some time later in the transfer cannot receive any more data bytes, the master must abort the transfer. This is indicated by the slave generating the not acknowledge on the first byte to follow. The slave leaves the data line HIGH and the master generates the STOP condition.

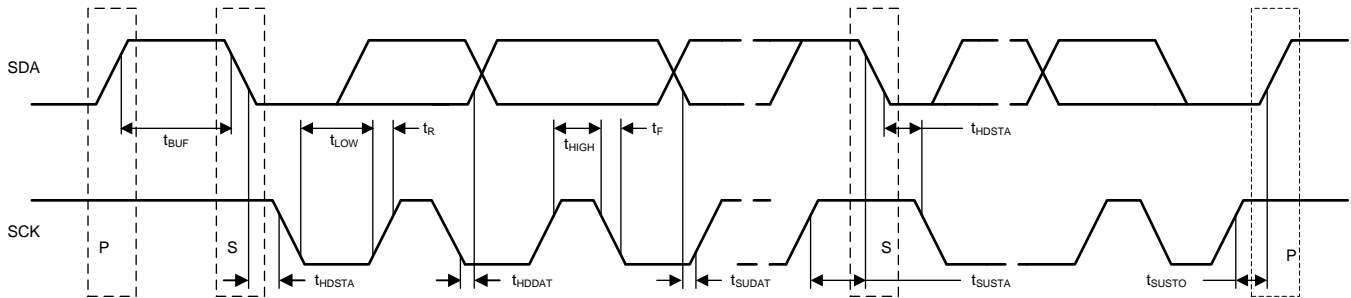
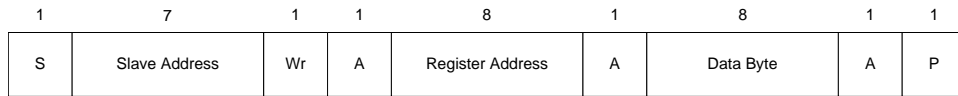

Figure 3. I²C Timing Diagram

Table 3. Timing Diagram Definitions

Parameter	Symbol	Min	Max	Unit
SCK clock frequency	f_{SCK}		400	kHz
Bus free time between STOP and START conditions	t_{BUF}	1.3		μs
Hold time after repeated START condition. After this period, the first clock pulse is generated	t_{HDSTA}	0.6		μs
Low period of the SCK clock	t_{LOW}	1.3		μs
High period of the SCK clock	t_{HIGH}	0.6		μs
Setup time for a repeated START condition	t_{SUSTA}	0.6		μs
Data HOLD time	t_{HDDAT}	0		μs
Data setup time	t_{SUDAT}	100		ns
Rise time of both SDA and SCK signals	t_R		300	ns
Fall time of both SDA and SCK signals	t_F		300	ns
Setup time for STOP condition	t_{SUSTO}	0.6		μs

Write Sequence



Read Sequence

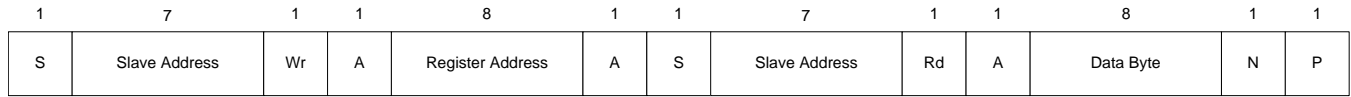

Legend

- | |
|---|
| S |
|---|

 Start Condition
- | |
|----|
| Wr |
|----|

 Write Bit (bit value = 0)
- | |
|----|
| Rd |
|----|

 Read Bit (bit value = 1)
- | |
|---|
| A |
|---|

 Acknowledge
- | |
|---|
| N |
|---|

 Not Acknowledge
- | |
|---|
| P |
|---|

 Stop Condition

Figure 4. Programming Sequence

REGISTER MAPPING

The register mapping for register addresses 0 (0x00) through 15 (0x0F) are listed in [Table 4](#) through [Table 15](#). [Table 16](#) describes the circuit functionality based on the register settings.

Table 4. Register 0 (0x00) Mapping – Control Settings

Register Address 0 (0x00)							
Bit 7	Bit 6	Bit 5	Bit 4	Bit 3	Bit 2	Bit 1	Bit 0
ENA	HITERM	PKENA	PKRNG	CPENA	POL	EQENA	AMPCTRL

Table 5. Register 1 (0x01) Mapping – Modulation Amplitude

Register Address 1 (0x01)							
Bit 7	Bit 6	Bit 5	Bit 4	Bit 3	Bit 2	Bit 1	Bit 0
AMP7	AMP6	AMP5	AMP4	AMP3	AMP2	AMP1	AMP0

Table 6. Register 2 (0x02) Mapping – Pre-Emphasis Adjust

Register Address 2 (0x02)							
Bit 7	Bit 6	Bit 5	Bit 4	Bit 3	Bit 2	Bit 1	Bit 0
-	-	-	-	PEADJ3	PEADJ2	PEADJ1	PEADJ0

Table 7. Register 3 (0x03) Mapping – Equalizer Adjust

Register Address 3 (0x03)							
Bit 7	Bit 6	Bit 5	Bit 4	Bit 3	Bit 2	Bit 1	Bit 0
EQADJ7	EQADJ6	EQADJ5	EQADJ4	EQADJ3	EQADJ2	EQADJ1	EQADJ0

Table 8. Register 4 (0x04) Mapping – Cross Point Adjust

Register Address 4 (0x04)							
Bit 7	Bit 6	Bit 5	Bit 4	Bit 3	Bit 2	Bit 1	Bit 0
CPSGN	CPADJ6	CPADJ5	CPADJ4	CPADJ3	CPADJ2	CPADJ1	CPADJ0

Table 9. Register 5 (0x05) Mapping – CPA Settings

Register Address 5 (0x05)							
Bit 7	Bit 6	Bit 5	Bit 4	Bit 3	Bit 2	Bit 1	Bit 0
OARNG	OASH1	OASH0	-	EFCRNG	-	HICP1	HICP0

Table 10. Register 6 (0x06) Mapping – Limiter Bias Current Adjust

Register Address 6 (0x06)							
Bit 7	Bit 6	Bit 5	Bit 4	Bit 3	Bit 2	Bit 1	Bit 0
LIMCSGN	LIMC2	LIMC1	LIMC0	EFCSGN	EFC2	EFC1	EFC0

Table 11. Register 7 (0x07) Mapping – ABT – Emitter Follower Control

Register Address 7 (0x07)							
Bit 7	Bit 6	Bit 5	Bit 4	Bit 3	Bit 2	Bit 1	Bit 0
ABTUP	ABTDWN	-	-	ABTSGN	ABTEF2	ABTEF1	ABTEF0

Table 12. Register 8 (0x08) – Register 12 (0x0C) Mapping – Not Used

Register Address 8 (0x08)							
Bit 7	Bit 6	Bit 5	Bit 4	Bit 3	Bit 2	Bit 1	Bit 0
-	-	-	-	-	-	-	-

Table 13. Register 13 (0x0D) Mapping – ADC Settings

Register Address 13 (0x0D)							
Bit 7	Bit 6	Bit 5	Bit 4	Bit 3	Bit 2	Bit 1	Bit 0
ADCDIS	OSCDIS	-	-	-	-	-	ADCSEL

Table 14. Register 14 (0x0E) Mapping – ADC Output (Read Only)

Register Address 14 (0x0E)							
Bit 7	Bit 6	Bit 5	Bit 4	Bit 3	Bit 2	Bit 1	Bit 0
ADC9	ADC8	ADC7	ADC6	ADC5	ADC4	ADC3	ADC2

Table 15. Register 15 (0x0F) Mapping – ADC Output (Read Only)

Register Address 15 (0x0F)							
Bit 7	Bit 6	Bit 5	Bit 4	Bit 3	Bit 2	Bit 1	Bit 0
-	-	-	-	-	-	ADC1	ADC0

Table 16. Register Functionality

Register	Bit	Symbol	Function
0	7	ENA	Enable chip bit: 1 = Chip enabled 0 = Chip disabled
	6	HITERM	SCK, SDA and DIS pin input termination select bit: 1 = 40 kΩ selected 0 = 10 kΩ selected
	5	PKENA	Output pre-emphasis enable bit: 1 = Pre-emphasis enabled (height controlled by register 2) 0 = Pre-emphasis disabled
	4	PKRNG	Output pre-emphasis range bit: 1 = High range enabled 0 = Default range
	3	CPENA	Cross point adjust enable bit: 1 = Cross point adjustment is enabled 0 = DC offset cancellation is enabled
	2	POL	Output polarity switch bit: 1: Pin 15 = OUT- and pin 14 = OUT+ 0: Pin 15 = OUT+ and pin 14 = OUT-
	1	EQENA	Input equalizer enable bit: 1 = Equalizer enabled (boost controlled by register 3) 0 = Equalizer disabled
	0	AMPCTRL	Amplitude control selection bit: 1 = Amplitude control through the serial interface 0 = Amplitude control by an analog voltage input at AMP pin
1	7	AMP7	Output amplitude setting Output voltage: 300 mV _{PP} to 1.5 V _{PP} in 256 steps
	6	AMP6	
	5	AMP5	
	4	AMP4	
	3	AMP3	
	2	AMP2	
	1	AMP1	
	0	AMP0	
2	7	-	
	6	-	
	5	-	
	4	-	
	3	PEADJ3	Pre-emphasis adjustment
	2	PEADJ2	0 = no pre-emphasis
	1	PEADJ1	> 0 = pre-emphasis added to output signal
	0	PEADJ0	
3	7	EQADJ7	Equalizer adjustment setting Maximum equalization for 00000000 Minimum equalization for 11111111
	6	EQADJ6	
	5	EQADJ5	
	4	EQADJ4	
	3	EQADJ3	
	2	EQADJ2	
	1	EQADJ1	
	0	EQADJ0	

Table 16. Register Functionality (continued)

Register	Bit	Symbol	Function	
4	7	CPSGN	Eye cross-point adjustment setting	
	6	CPADJ6	CPSGN = 0 (positive shift)	
	5	CPADJ5	Maximum shift for 1111111	
	4	CPADJ4	Minimum shift for 0000000	
	3	CPADJ3	CPSGN = 1 (negative shift)	
	2	CPADJ2	Maximum shift for 1111111	
	1	CPADJ1	Minimum shift for 0000000	
	0	CPADJ0		
5	7	OARNG	Output amplitude range bit: 1 = Decrease output amplitude by approximately 18% 0 = Default range	
	6	OASH1	Upper output amplitude shift bit: 1 = Output amplitude shifted upwards by approximately 60 mV _{PP} 0 = Default	
	5	OASH0	Lower output amplitude shift bit: 1 = Output amplitude shifted upwards by approximately 30 mV _{PP} 0 = Default	
	4	-		
	3	EFCRNG	Emitter follower current slope selection: 1 = Step slope 0 = Shallow slope	
	2	-		
	1 0	HICP1 HICP0	High cross point adjustment range bits: 00 = Default adjustment range 11 = Maximum increase in the adjustment range	
6	7	LIMCSGN	Limiter bias current sign bit: 1 = Decrease limiter bias current 0 = Increase limiter bias current	
	6 5 4	LIMC2 LIMC1 LIMC0	Limiter bias current selection bits: 000 = No change 111 = Maximum current change	
	3	EFCSGN	Emitter follower current sign bit: 1 = Increase emitter follower current 0 = Decrease emitter follower current	
	2 1 0	EFC2 EFC1 EFC0	Emitter follower current selection bits: 000 = No change 111 = Maximum current change	
	7	7	ABTUP	Active back termination auxiliary buffer amplitude control bit: 1 = Increase amplitude 0 = Default setting
		6	ABTDWN	Active back termination auxiliary buffer amplitude control bit: 1 = Decrease amplitude 0 = Default setting
		5	-	
4		-		
3		ABTSGN	Active back termination emitter follower current sign bit: 1 = Increase emitter follower current 0 = Decrease emitter follower current	
2 1 0		ABTEF2 ABTEF1 ABTEF0	Active back termination emitter follower current selection bits: 000 = No change 111 = Maximum current change	

Table 16. Register Functionality (continued)

Register	Bit	Symbol	Function
13	7	ADCDIS	ADC disable bit: 1 = ADC disabled 0 = ADC enabled
	6	OSCDIS	ADC oscillator bit: 1 = Oscillator disabled 0 = Oscillator enabled
	5	-	
	4	-	
	3	-	
	2	-	
	1	-	
	0	ADCSEL	ADC input selection bits: 1 = Supply monitor 0 = Temperature sensor
14	7	ADC9 (MSB)	Digital representation of the ADC input source (read only)
	6	ADC8	
	5	ADC7	
	4	ADC6	
	3	ADC5	
	2	ADC4	
	1	ADC3	
	0	ADC2	
15	7	-	
	6	-	
	5	-	
	4	-	
	3	-	
	2	-	
	1	ADC1	Digital representation of the ADC input source (read only)
	0	ADC0 (LSB)	

APPLICATION INFORMATION

Figure 5 shows a typical application circuit using the ONET1151M. The modulator must be AC coupled to the driver for proper operation. The output amplitude is controlled through the AMP pin and the rest of the functions are controlled through the 2-wire interface (SDA or SCK) by a microcontroller.

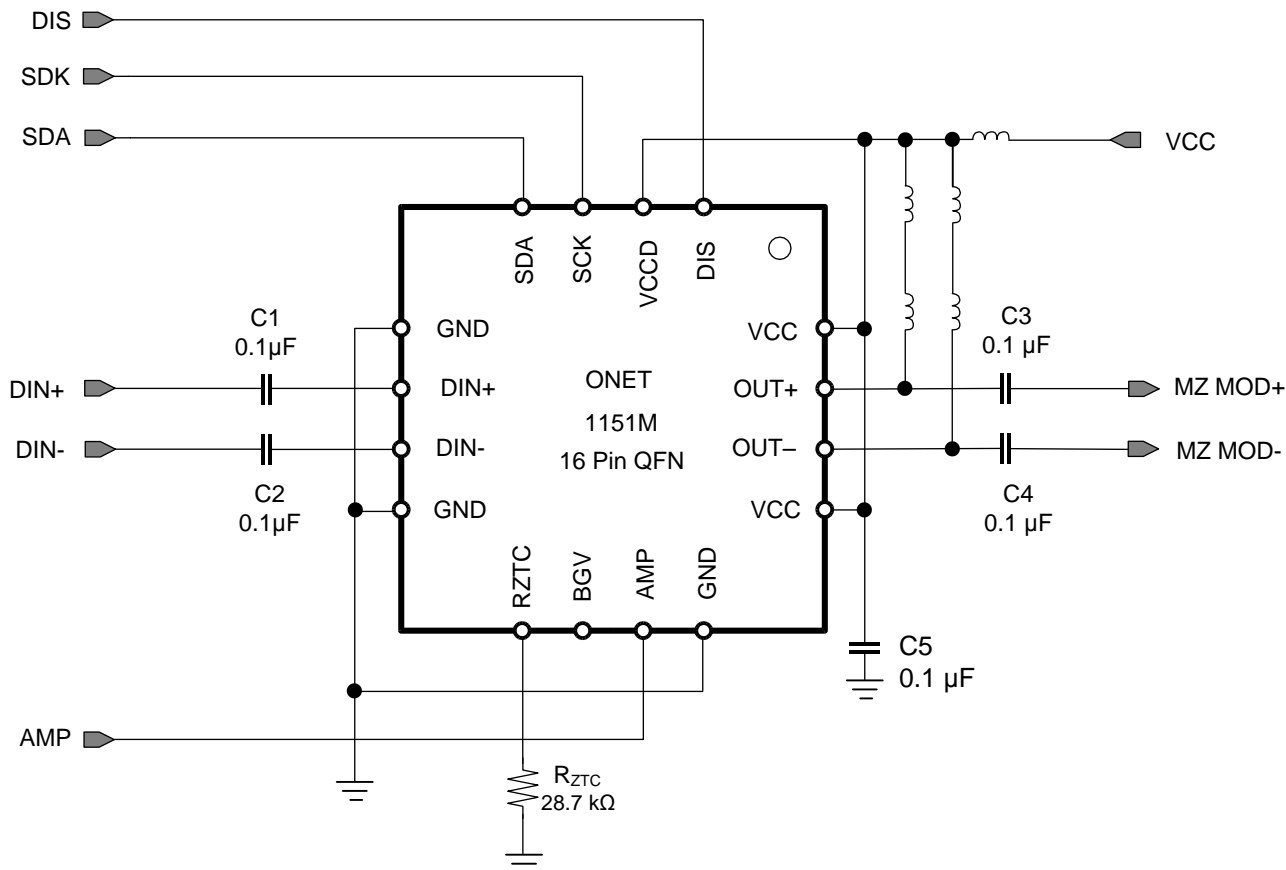

Pullup inductors from MOD+ and MOD- to VCC are required.

Figure 5. Differential AC Coupled Drive

Layout Guidelines

For optimum performance, use 50-Ω transmission lines (100-Ω differential) for connecting the signal source to the DIN+ and DIN- pins and 50-Ω transmission lines (100-Ω differential) for connecting the OUT+ and OUT- modulation current outputs to the modulator. The length of the transmission lines should be kept as short as possible to reduce loss and pattern-dependent jitter.

In addition, VCCD can be connected to VCC and filtered from a common supply.

TYPICAL CHARACTERISTICS

Typical operating condition is at $V_{CC} = 3.3\text{ V}$, $T_A = 25^\circ\text{C}$, $V_{OUT} = 1.5\text{ V}_{PP}$ single ended, EQENA = 0, PKENA = 1 with PEADJ = 0x0F and $V_{IN} = 600\text{ mV}_{PP}$ (unless otherwise noted).

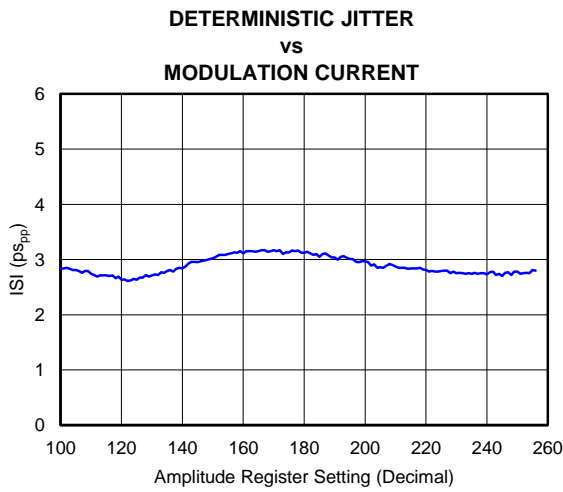

Figure 6.

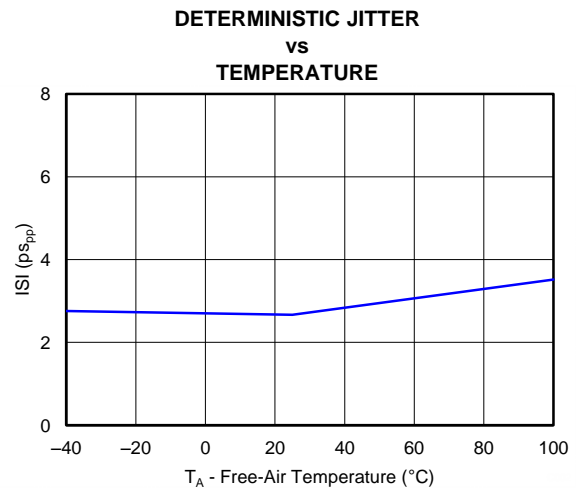

Figure 7.

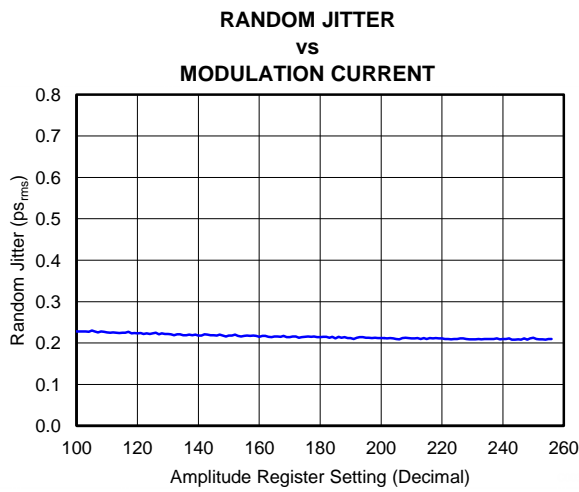

Figure 8.

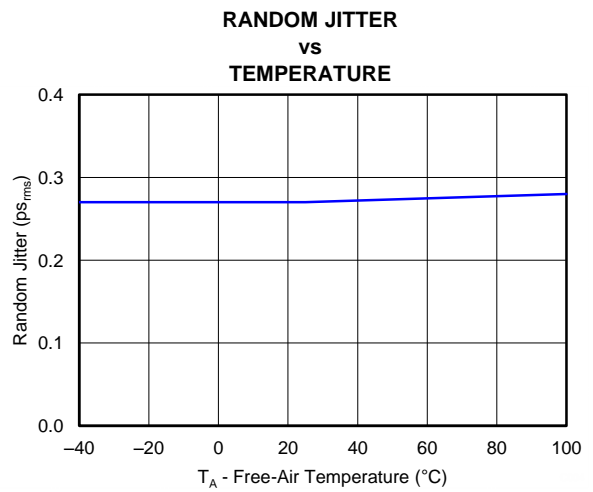

Figure 9.

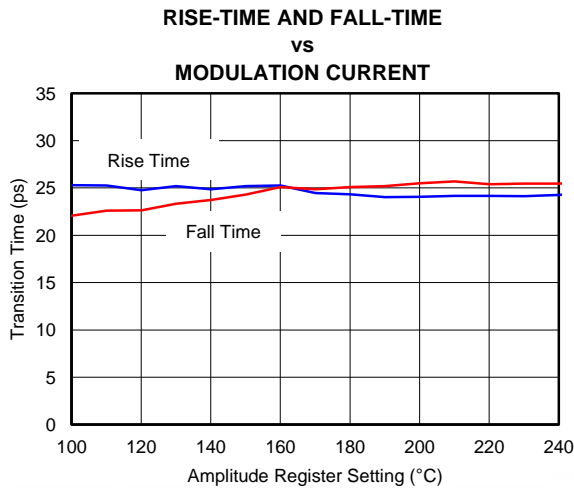

Figure 10.

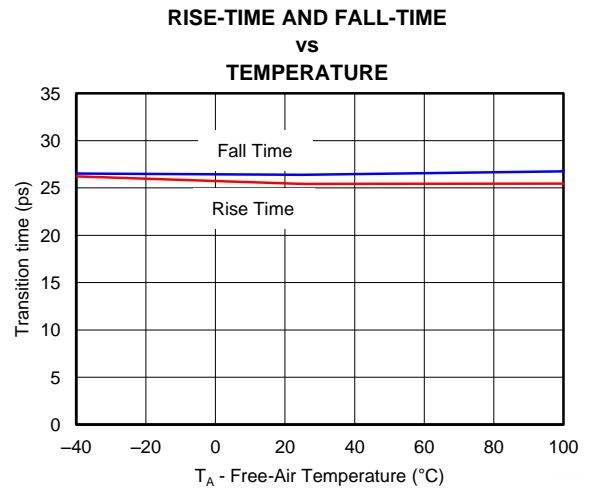

Figure 11.

TYPICAL CHARACTERISTICS (continued)

Typical operating condition is at $V_{CC} = 3.3\text{ V}$, $T_A = 25^\circ\text{C}$, $V_{OUT} = 1.5\text{ V}_{PP}$ single ended, $EQENA = 0$, $PKENA = 1$ with $PEADJ = 0x0F$ and $V_{IN} = 600\text{ mV}_{PP}$ (unless otherwise noted).

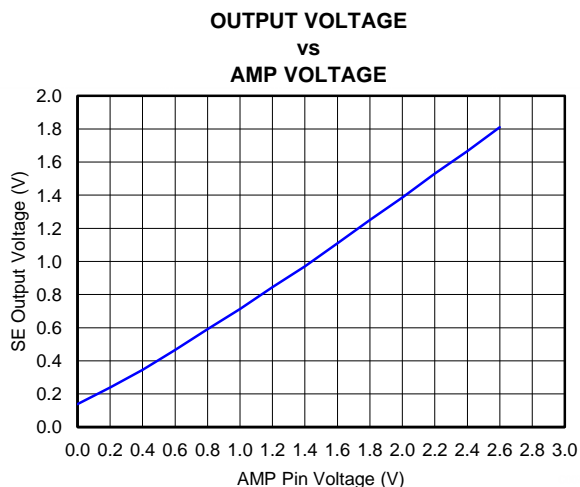

Figure 12.

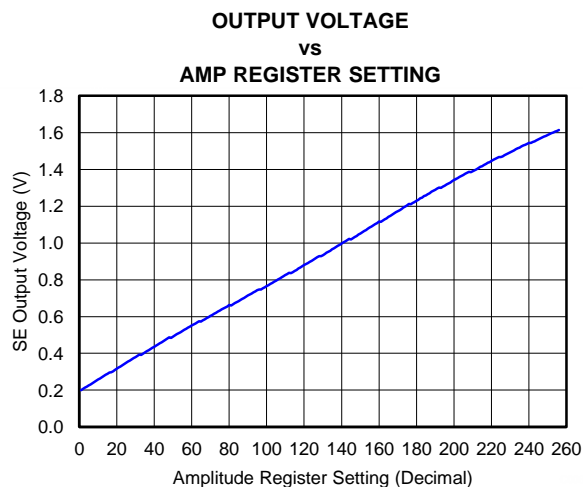

Figure 13.

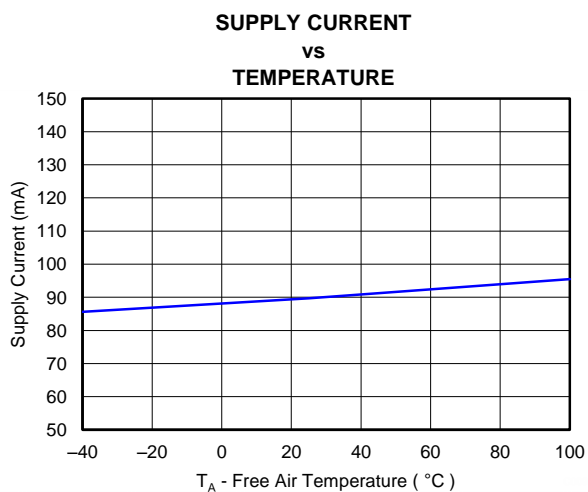

Figure 14.

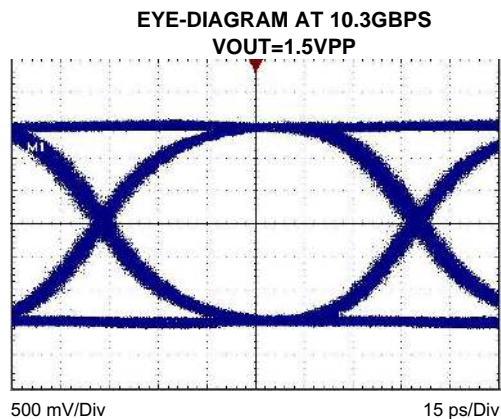

Figure 15.

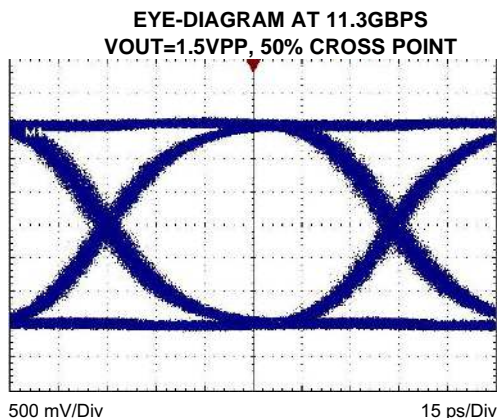

Figure 16.

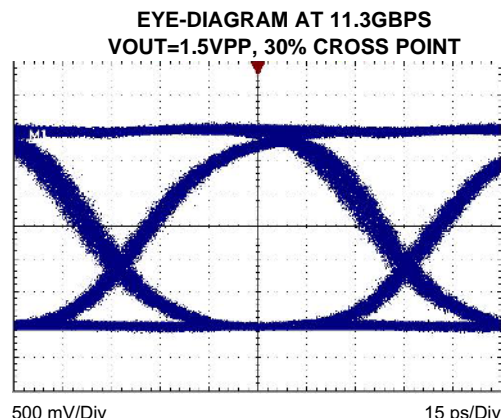

Figure 17.

TYPICAL CHARACTERISTICS (continued)

Typical operating condition is at $V_{CC} = 3.3\text{ V}$, $T_A = 25^\circ\text{C}$, $V_{OUT} = 1.5\text{ V}_{PP}$ single ended, EQENA = 0, PKENA = 1 with PEADJ = 0x0F and $V_{IN} = 600\text{ mV}_{PP}$ (unless otherwise noted).

**EYE-DIAGRAM AT 11.3GBPS
VOUT=1.5VPP, 70% CROSS POINT**

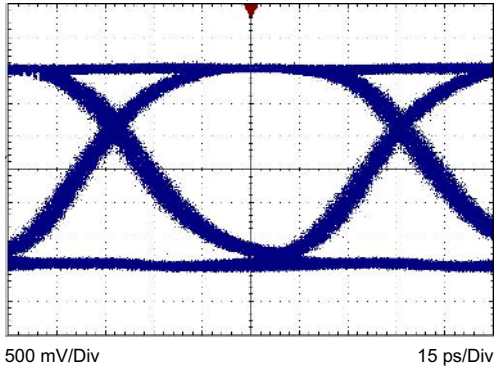

Figure 18.

**EYE-DIAGRAM AT 11.3GBPS
VOUT=1.5VPP, EQ SET TO 00,
12" OF FR4 AT INPUTS**

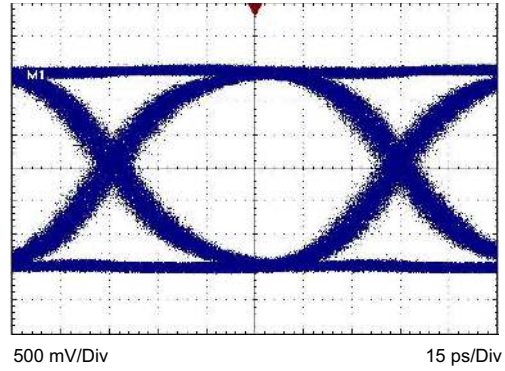

Figure 19.

PACKAGING INFORMATION

Orderable Device	Status (1)	Package Type	Package Drawing	Pins	Package Qty	Eco Plan (2)	Lead finish/ Ball material (6)	MSL Peak Temp (3)	Op Temp (°C)	Device Marking (4/5)	Samples
ONET1151MRGTR	ACTIVE	VQFN	RGT	16	3000	RoHS & Green	NIPDAU	Level-1-260C-UNLIM	-40 to 100	1151M	Samples
ONET1151MRGTT	ACTIVE	VQFN	RGT	16	250	RoHS & Green	NIPDAU	Level-1-260C-UNLIM	-40 to 100	1151M	Samples

(1) The marketing status values are defined as follows:

ACTIVE: Product device recommended for new designs.

LIFEBUY: TI has announced that the device will be discontinued, and a lifetime-buy period is in effect.

NRND: Not recommended for new designs. Device is in production to support existing customers, but TI does not recommend using this part in a new design.

PREVIEW: Device has been announced but is not in production. Samples may or may not be available.

OBSOLETE: TI has discontinued the production of the device.

(2) **RoHS:** TI defines "RoHS" to mean semiconductor products that are compliant with the current EU RoHS requirements for all 10 RoHS substances, including the requirement that RoHS substance do not exceed 0.1% by weight in homogeneous materials. Where designed to be soldered at high temperatures, "RoHS" products are suitable for use in specified lead-free processes. TI may reference these types of products as "Pb-Free".

RoHS Exempt: TI defines "RoHS Exempt" to mean products that contain lead but are compliant with EU RoHS pursuant to a specific EU RoHS exemption.

Green: TI defines "Green" to mean the content of Chlorine (Cl) and Bromine (Br) based flame retardants meet JS709B low halogen requirements of <=1000ppm threshold. Antimony trioxide based flame retardants must also meet the <=1000ppm threshold requirement.

(3) MSL, Peak Temp. - The Moisture Sensitivity Level rating according to the JEDEC industry standard classifications, and peak solder temperature.

(4) There may be additional marking, which relates to the logo, the lot trace code information, or the environmental category on the device.

(5) Multiple Device Markings will be inside parentheses. Only one Device Marking contained in parentheses and separated by a "~" will appear on a device. If a line is indented then it is a continuation of the previous line and the two combined represent the entire Device Marking for that device.

(6) Lead finish/Ball material - Orderable Devices may have multiple material finish options. Finish options are separated by a vertical ruled line. Lead finish/Ball material values may wrap to two lines if the finish value exceeds the maximum column width.

Important Information and Disclaimer:The information provided on this page represents TI's knowledge and belief as of the date that it is provided. TI bases its knowledge and belief on information provided by third parties, and makes no representation or warranty as to the accuracy of such information. Efforts are underway to better integrate information from third parties. TI has taken and continues to take reasonable steps to provide representative and accurate information but may not have conducted destructive testing or chemical analysis on incoming materials and chemicals. TI and TI suppliers consider certain information to be proprietary, and thus CAS numbers and other limited information may not be available for release.

In no event shall TI's liability arising out of such information exceed the total purchase price of the TI part(s) at issue in this document sold by TI to Customer on an annual basis.

TAPE AND REEL INFORMATION

QUADRANT ASSIGNMENTS FOR PIN 1 ORIENTATION IN TAPE

*All dimensions are nominal

Device	Package Type	Package Drawing	Pins	SPQ	Reel Diameter (mm)	Reel Width W1 (mm)	A0 (mm)	B0 (mm)	K0 (mm)	P1 (mm)	W (mm)	Pin1 Quadrant
ONET1151MRGTR	VQFN	RGT	16	3000	330.0	12.4	3.3	3.3	1.1	8.0	12.0	Q2
ONET1151MRGTT	VQFN	RGT	16	250	180.0	12.4	3.3	3.3	1.1	8.0	12.0	Q2

TAPE AND REEL BOX DIMENSIONS



*All dimensions are nominal

Device	Package Type	Package Drawing	Pins	SPQ	Length (mm)	Width (mm)	Height (mm)
ONET1151MRGTR	VQFN	RGT	16	3000	335.0	335.0	25.0
ONET1151MRGTT	VQFN	RGT	16	250	182.0	182.0	20.0

RGT 16

GENERIC PACKAGE VIEW

VQFN - 1 mm max height

PLASTIC QUAD FLATPACK - NO LEAD

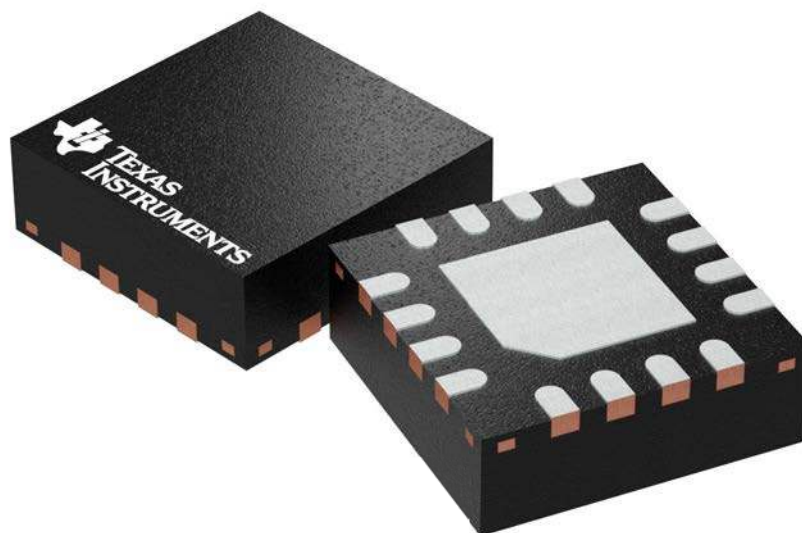

Images above are just a representation of the package family, actual package may vary.
Refer to the product data sheet for package details.

4203495/1

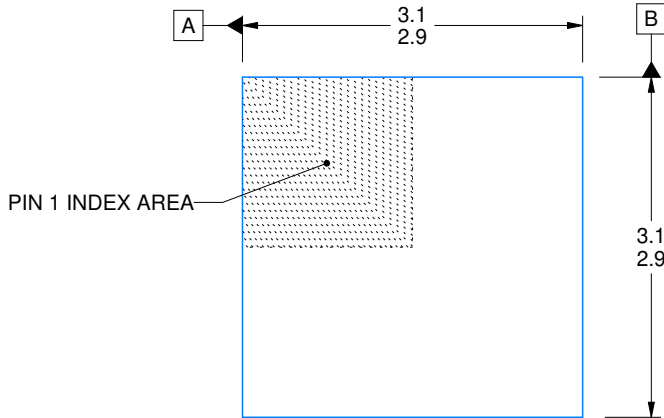

SIDE WALL METAL THICKNESS DIM A	
OPTION 1	OPTION 2
0.1	0.2

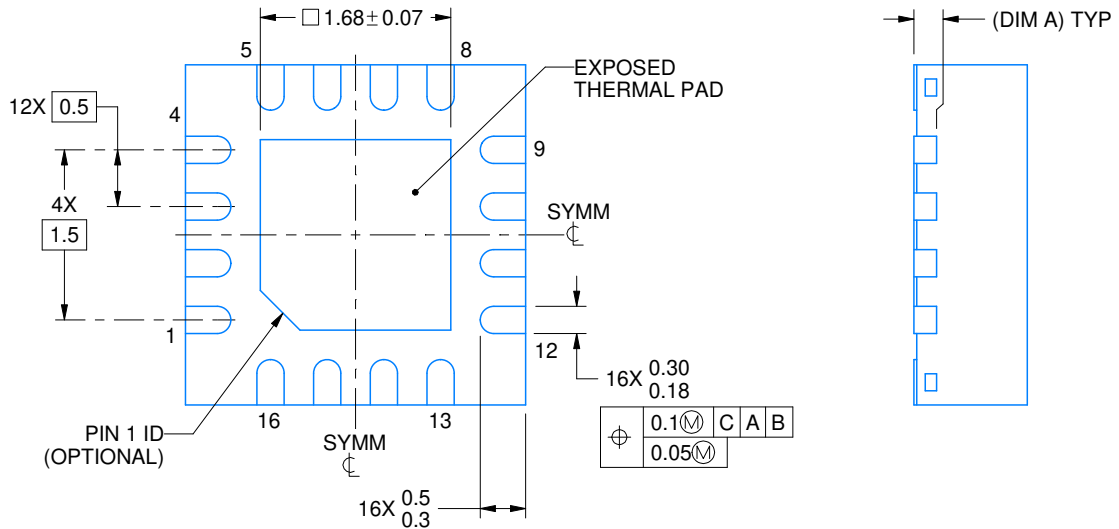
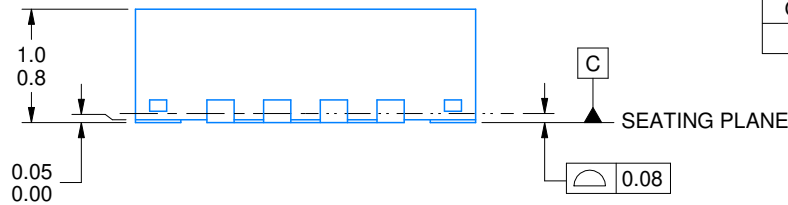

4222419/D 04/2022

NOTES:

1. All linear dimensions are in millimeters. Any dimensions in parenthesis are for reference only. Dimensioning and tolerancing per ASME Y14.5M.
2. This drawing is subject to change without notice.
3. The package thermal pad must be soldered to the printed circuit board for thermal and mechanical performance.

EXAMPLE BOARD LAYOUT

RGT0016C

VQFN - 1 mm max height

PLASTIC QUAD FLATPACK - NO LEAD

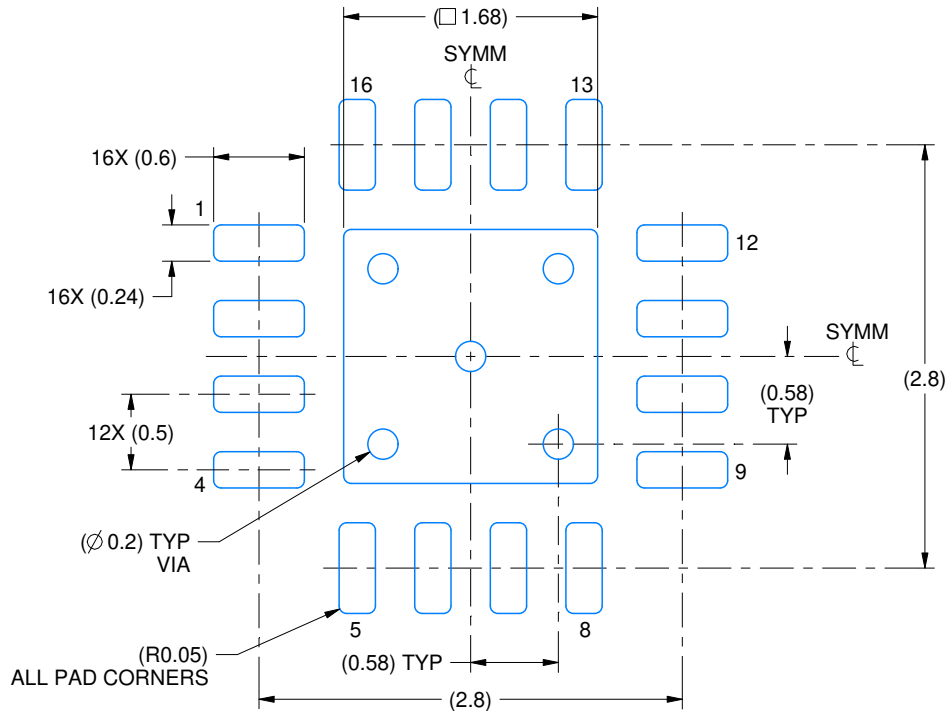

LAND PATTERN EXAMPLE
EXPOSED METAL SHOWN
SCALE:20X

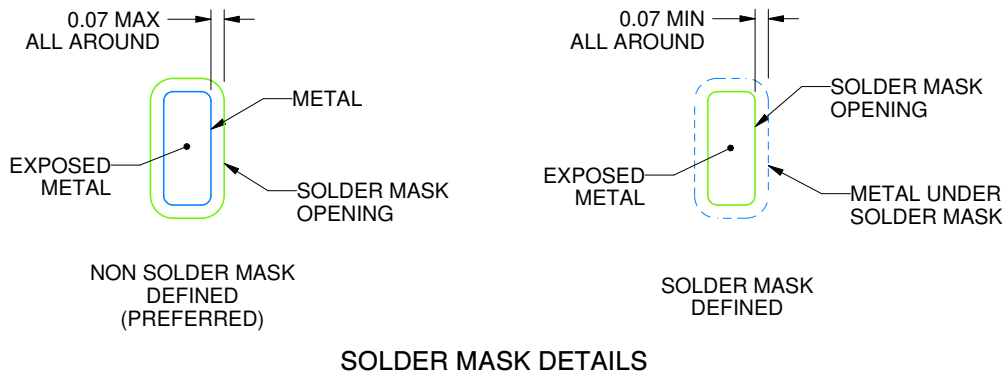

SOLDER MASK DETAILS

4222419/D 04/2022

NOTES: (continued)

- This package is designed to be soldered to a thermal pad on the board. For more information, see Texas Instruments literature number SLUA271 (www.ti.com/lit/slua271).
- Vias are optional depending on application, refer to device data sheet. If any vias are implemented, refer to their locations shown on this view. It is recommended that vias under paste be filled, plugged or tented.

EXAMPLE STENCIL DESIGN

RGT0016C

VQFN - 1 mm max height

PLASTIC QUAD FLATPACK - NO LEAD

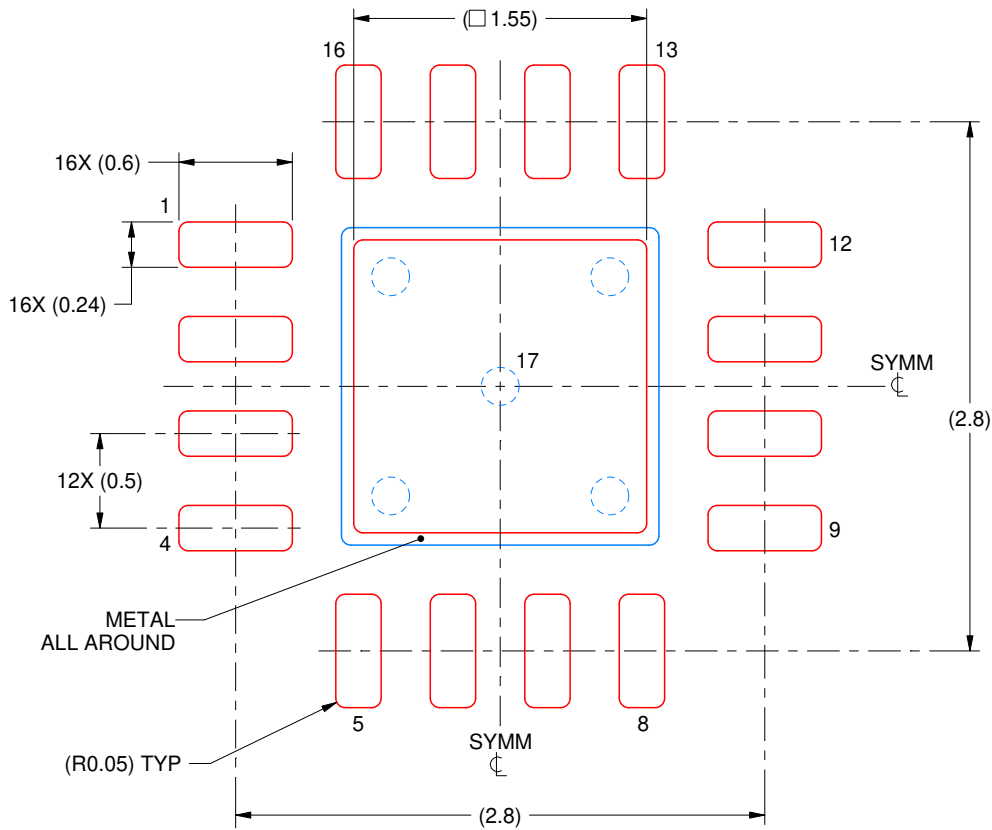

SOLDER PASTE EXAMPLE
BASED ON 0.125 mm THICK STENCIL

EXPOSED PAD 17:
85% PRINTED SOLDER COVERAGE BY AREA UNDER PACKAGE
SCALE:25X

4222419/D 04/2022

NOTES: (continued)

6. Laser cutting apertures with trapezoidal walls and rounded corners may offer better paste release. IPC-7525 may have alternate design recommendations.

IMPORTANT NOTICE AND DISCLAIMER

TI PROVIDES TECHNICAL AND RELIABILITY DATA (INCLUDING DATA SHEETS), DESIGN RESOURCES (INCLUDING REFERENCE DESIGNS), APPLICATION OR OTHER DESIGN ADVICE, WEB TOOLS, SAFETY INFORMATION, AND OTHER RESOURCES "AS IS" AND WITH ALL FAULTS, AND DISCLAIMS ALL WARRANTIES, EXPRESS AND IMPLIED, INCLUDING WITHOUT LIMITATION ANY IMPLIED WARRANTIES OF MERCHANTABILITY, FITNESS FOR A PARTICULAR PURPOSE OR NON-INFRINGEMENT OF THIRD PARTY INTELLECTUAL PROPERTY RIGHTS.

These resources are intended for skilled developers designing with TI products. You are solely responsible for (1) selecting the appropriate TI products for your application, (2) designing, validating and testing your application, and (3) ensuring your application meets applicable standards, and any other safety, security, regulatory or other requirements.

These resources are subject to change without notice. TI grants you permission to use these resources only for development of an application that uses the TI products described in the resource. Other reproduction and display of these resources is prohibited. No license is granted to any other TI intellectual property right or to any third party intellectual property right. TI disclaims responsibility for, and you will fully indemnify TI and its representatives against, any claims, damages, costs, losses, and liabilities arising out of your use of these resources.

TI's products are provided subject to [TI's Terms of Sale](#) or other applicable terms available either on [ti.com](https://www.ti.com) or provided in conjunction with such TI products. TI's provision of these resources does not expand or otherwise alter TI's applicable warranties or warranty disclaimers for TI products.

TI objects to and rejects any additional or different terms you may have proposed.

Mailing Address: Texas Instruments, Post Office Box 655303, Dallas, Texas 75265
Copyright © 2023, Texas Instruments Incorporated