

# Printed-circuit board connector - MSTBVA 2,5/19-G-5,08-LR - 1809432

Please be informed that the data shown in this PDF Document is generated from our Online Catalog. Please find the complete data in the user's documentation. Our General Terms of Use for Downloads are valid (<http://download.phoenixcontact.com>)

Header, Nominal current: 12 A, Rated voltage (III/2): 320 V, Number of positions: 19, Pitch: 5.08 mm, Color: green, Contact surface: Tin, Assembly: Soldering



## Key commercial data

Packing unit	0
Minimum order quantity	1
GTIN	 4 046356 703680
Custom tariff number	85366990
Country of origin	GERMANY

## Technical data

### Dimensions / positions

Length	8.6 mm
Height	14.6 mm
Pitch	5.08 mm
Dimension a	91.44 mm
Number of positions	19
Pin dimensions	1 x 1 mm
Hole diameter	1.4 mm

### Technical data

Range of articles	MSTBVA 2,5/...-G-LR
Insulating material group	IIIa
Rated surge voltage (III/3)	4 kV
Rated surge voltage (III/2)	4 kV
Rated surge voltage (II/2)	4 kV
Rated voltage (III/2)	320 V
Rated voltage (II/2)	400 V
Connection in acc. with standard	EN-VDE
Nominal current I <sub>N</sub>	12 A
Nominal voltage U <sub>N</sub>	250 V
Maximum load current	12 A

# Printed-circuit board connector - MSTBVA 2,5/19-G-5,08-LR - 1809432

## Technical data

### Technical data

Insulating material	PBT
Inflammability class according to UL 94	V0
Color	green

## Classifications

### eclass

eCl@ss 5.1	27141190
eCl@ss 6.0	27260704

## Accessories

### Accessories

### Assembly

Accessories - MSTB-BL - 1755477



Keying cap, for forming sections, plugs onto header pin, green insulating material

---

## Marking

Marker cards - SK 5,08/3,8:FORTL.ZAHLEN - 0804293



Marker cards, Card, white, Labeled, Horizontal: Consecutive numbers 1 - 10, 11 - 20, etc. up to 91 - (99)100, Mounting type: Adhesive, For terminal block width: 5.08 mm

---

## Plug/Adapter

Keying star - CR-MSTB - 1734401



Coding section, inserted into the recess in the header or the inverted plug, red insulating material

---

## Drawings

# Printed-circuit board connector - MSTBVA 2,5/19-G-5,08-LR - 1809432

Drilling diagram

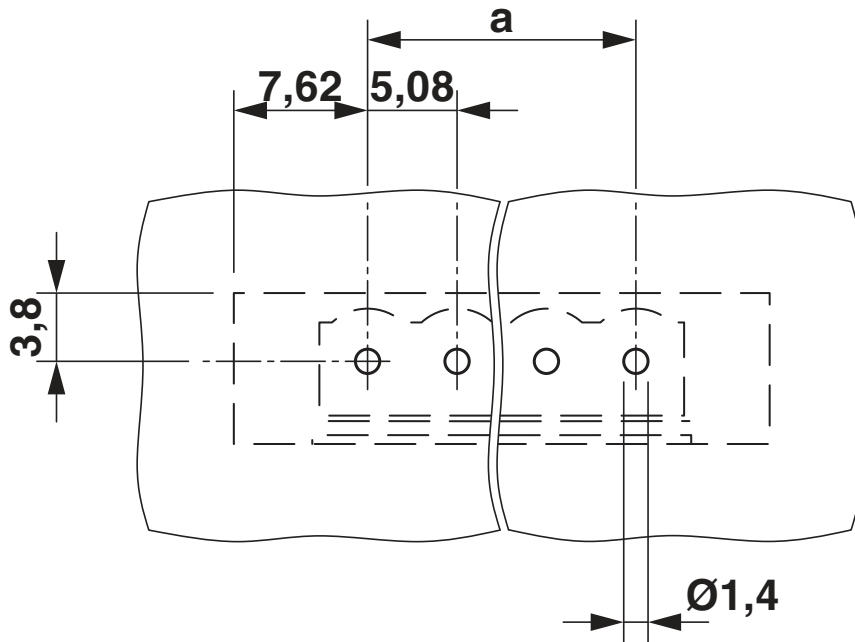

# Printed-circuit board connector - MSTBVA 2,5/19-G-5,08-LR - 1809432

Dimensioned drawing

