

High Voltage BIMOSFET™ Monolithic Bipolar MOS Transistor

N-Channel, Enhancement Mode

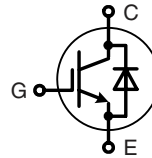

$I_{C25} = 33 \text{ A}$
 $V_{CES} = 1600 \text{ V}$
 $V_{CE(sat)} = 6.2 \text{ V typ.}$
 $t_{fi} = 40 \text{ ns}$

TO-247 AD

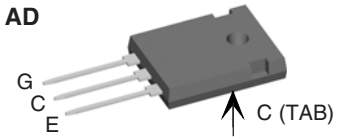

G = Gate,
E = Emitter,
C = Collector,
TAB = Collector

Symbol	Conditions	Maximum Ratings	
V_{CES}	$T_J = 25^\circ\text{C to } 150^\circ\text{C}$	1600	V
V_{CGR}	$T_J = 25^\circ\text{C to } 150^\circ\text{C}; R_{GE} = 1 \text{ M}\Omega$	1600	V
V_{GES}	Continuous	± 20	V
V_{GEM}	Transient	± 30	V
I_{C25}	$T_C = 25^\circ\text{C}$	33	A
I_{C90}	$T_C = 90^\circ\text{C}$	20	A
I_{CM}	$T_C = 25^\circ\text{C}, 1 \text{ ms}$	40	A
SSOA (RBSOA)	$V_{GE} = 15 \text{ V}, T_{VJ} = 125^\circ\text{C}, R_G = 22 \Omega, V_{CE} = 0.8 \cdot V_{CES}$ Clamped inductive load, $L = 100 \mu\text{H}$	$I_{CM} = 40$	A
P_C	$T_C = 25^\circ\text{C}$	350	W
T_J		-55 ... +150	$^\circ\text{C}$
T_{JM}		150	$^\circ\text{C}$
T_{stg}		-55 ... +150	$^\circ\text{C}$
T_L	1.6 mm (0.063 in) from case for 10 s	300	$^\circ\text{C}$
M_d	Mounting torque	1.15/10Nm/lb.in.	
Weight		6	g

Features

- International standard package JEDEC TO-247 AD
- High Voltage BIMOSFET™
 - replaces high voltage Darlington's and series connected MOSFET's
 - lower effective $R_{DS(on)}$
- Monolithic construction
 - high blocking voltage capability
 - very fast turn-off characteristics
- MOS Gate turn-on
 - drive simplicity
- Intrinsic diode

Applications

- AC motor speed control
- DC servo and robot drives
- DC choppers
- Uninterruptible power supplies (UPS)
- Switched-mode and resonant-mode power supplies
- CRT deflection
- Lamp ballasts

Advantages

- Easy to mount with 1 screw (isolated mounting screw hole)
- Space savings
- High power density

Symbol	Conditions	Characteristic Values ($T_J = 25^\circ\text{C}$, unless otherwise specified)		
		min.	typ.	max.
BV_{CES}	$I_C = 1 \text{ mA}, V_{GE} = 0 \text{ V}$	1600		V
$V_{GE(th)}$	$I_C = 2 \text{ mA}, V_{CE} = V_{GE}$	4		8 V
I_{CES}	$V_{CE} = 0.8 \cdot V_{CES}$ $V_{GE} = 0 \text{ V}$			$T_J = 25^\circ\text{C}$ 400 μA $T_J = 125^\circ\text{C}$ 3 mA
I_{GES}	$V_{CE} = 0 \text{ V}, V_{GE} = \pm 20 \text{ V}$			$\pm 500 \text{ nA}$
$V_{CE(sat)}$	$I_C = I_{C90}, V_{GE} = 15 \text{ V}$		6.2	$T_J = 125^\circ\text{C}$ 7.1 V 7.8 V

Symbol	Conditions	Characteristic Values		
		(T _J = 25°C, unless otherwise specified)		
		min.	typ.	max.
C _{ies}	V _{CE} = 25 V, V _{GE} = 0 V, f = 1 MHz		3300	pF
C _{oes}			220	pF
C _{res}			30	pF
Q _g	I _C = 20 A, V _{CE} = 600 V, V _{GE} = 15 V		130	nC
t _{d(on)}	Inductive load, T _J = 125°C I _C = I _{C90} , V _{GE} = 15 V, L = 100 μH, V _{CE} = 960 V, R _G = 22 Ω		200	ns
t _{ri}			60	ns
t _{d(off)}			270	ns
t _{fi}			40	ns
R _{thJC}				0.35 K/W
R _{thCK}		0.25		K/W

Symbol	Conditions	Characteristic Values		
		(T _J = 25°C, unless otherwise specified)		
		min.	typ.	max.
V _F	I _F = I _{C90} , V _{GE} = 0 V, Pulse test t ≤ 300 μs, duty cycle d ≤ 2%		2.5	5 V

TO-247 AD Outline

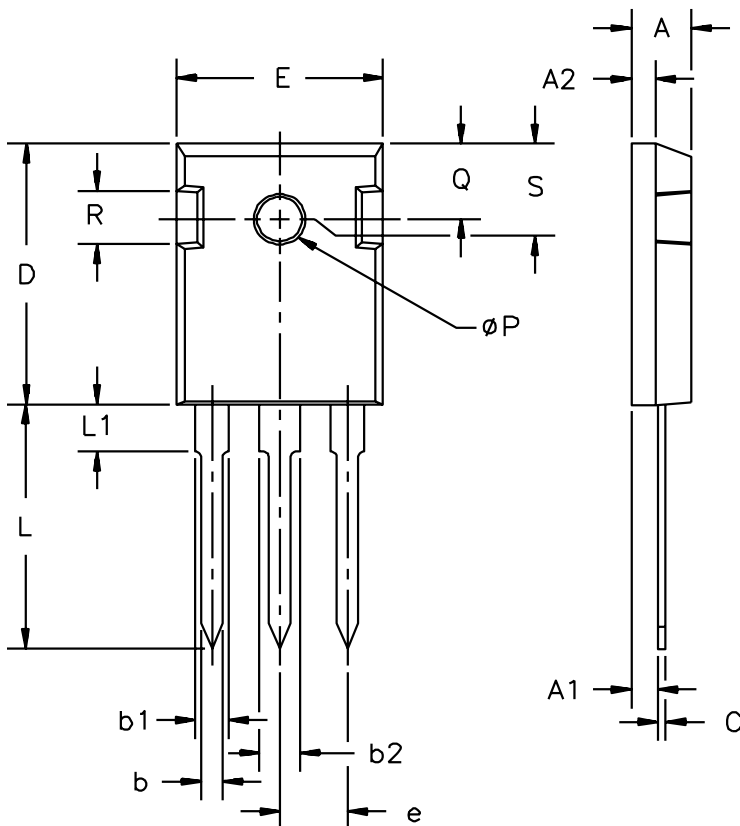

Dim.	Millimeter		Inches	
	Min.	Max.	Min.	Max.
A	19.81	20.32	0.780	0.800
B	20.80	21.46	0.819	0.845
C	15.75	16.26	0.610	0.640
D	3.55	3.65	0.140	0.144
E	4.32	5.49	0.170	0.216
F	5.4	6.2	0.212	0.244
G	1.65	2.13	0.065	0.084
H	-	4.5	-	0.177
J	1.0	1.4	0.040	0.055
K	10.8	11.0	0.426	0.433
L	4.7	5.3	0.185	0.209
M	0.4	0.8	0.016	0.031
N	1.5	2.49	0.087	0.102

IXYS reserves the right to change limits, test conditions and dimensions.

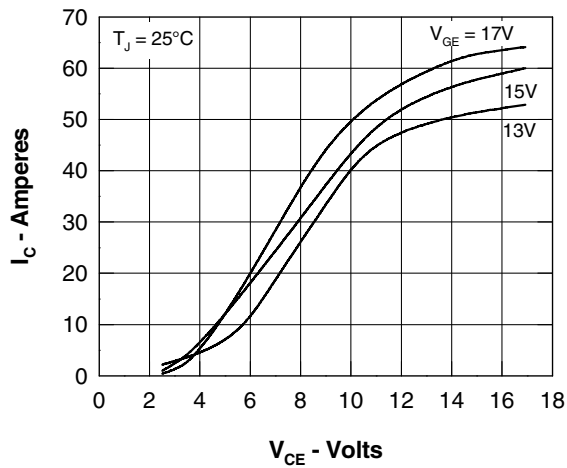

Fig. 1 Typ. Output Characteristics

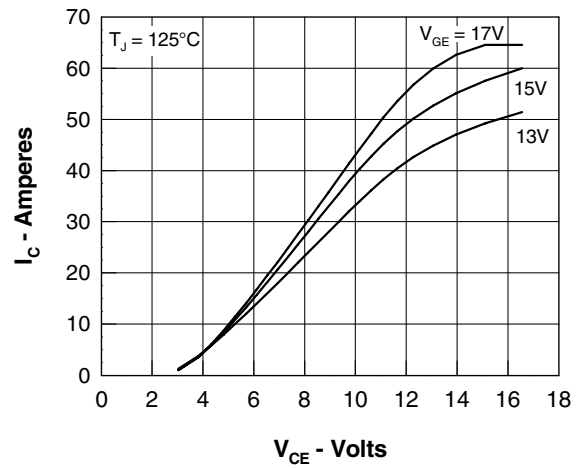

Fig. 2 Typ. Output Characteristics

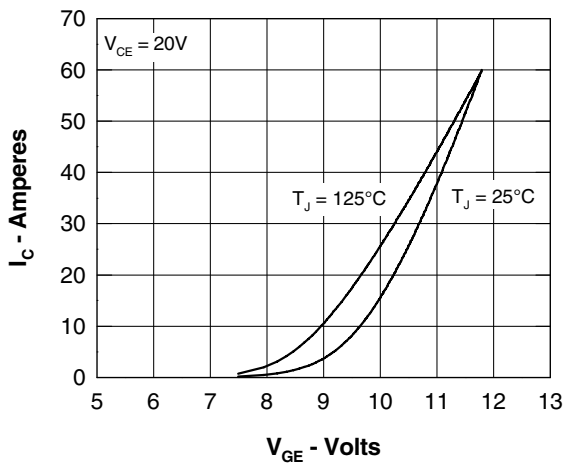

Fig. 3 Typ. Transfer Characteristics

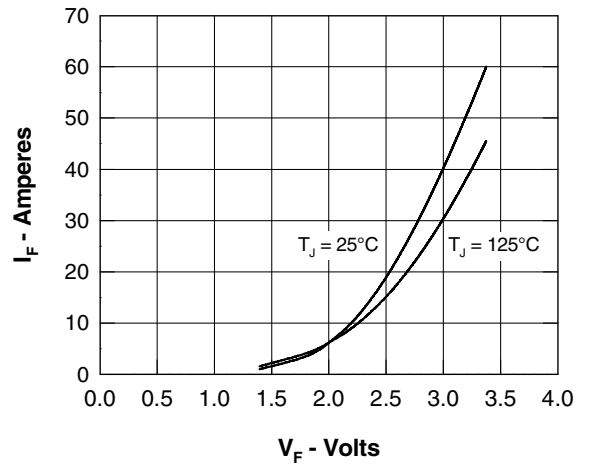

Fig. 4 Typ. Characteristics of Reverse Conduction

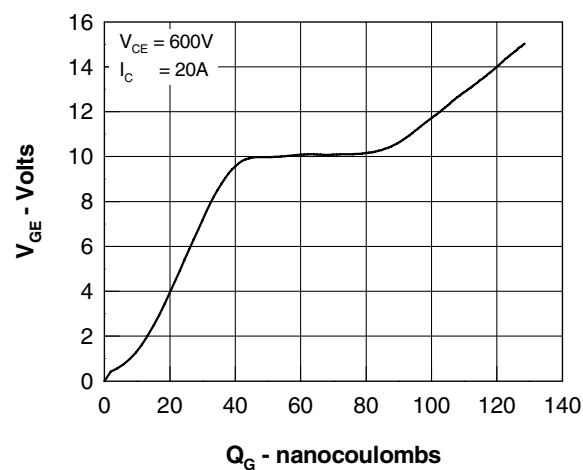

Fig. 5 Typ. Gate Charge characteristics

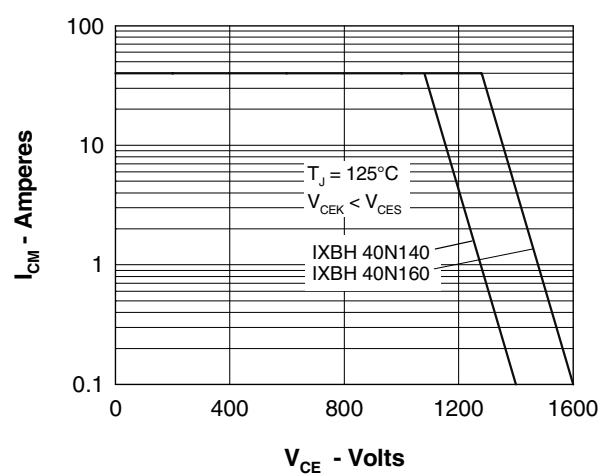

Fig. 6 Reverse Based Safe Operating Area RBSOA

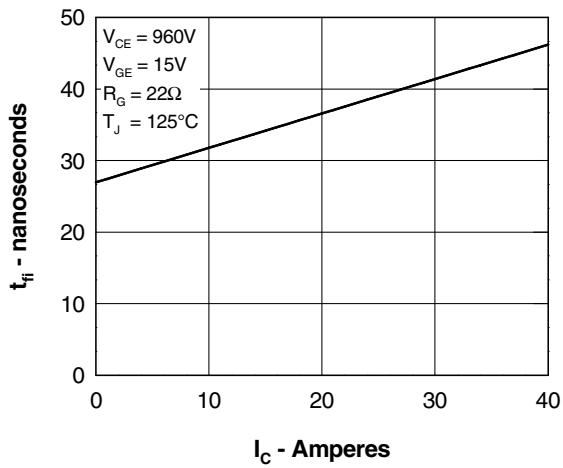

Fig. 7 Typ. Fall Time

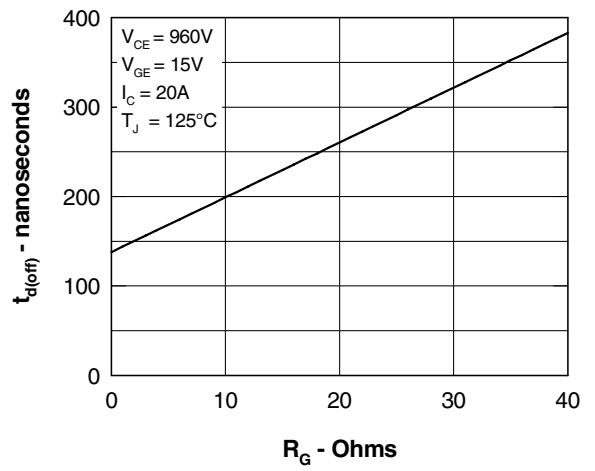

Fig. 8 Typ. Turn Off Delay Time

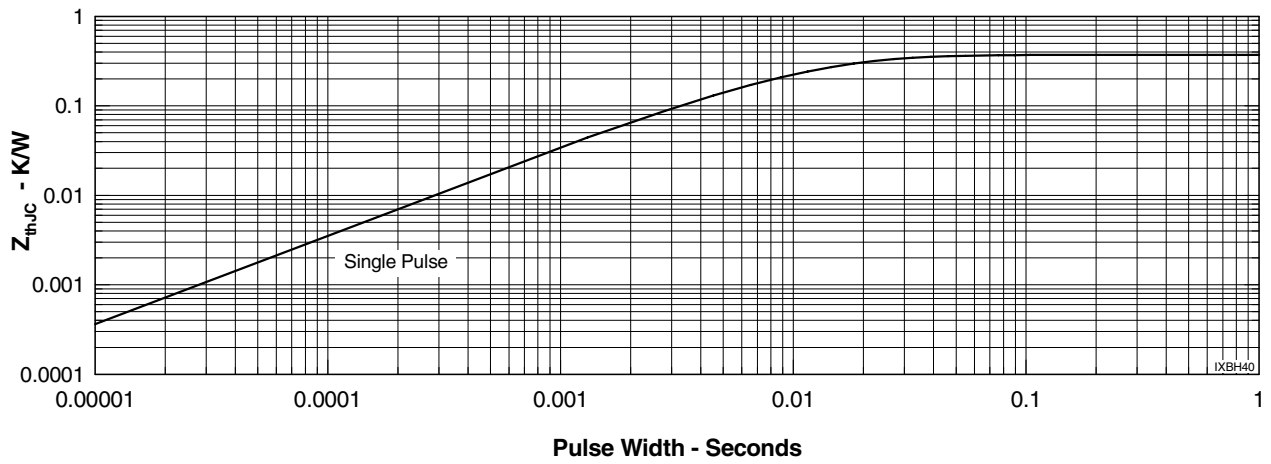

Fig. 9 Typ. Transient Thermal Impedance



Disclaimer Notice - Information furnished is believed to be accurate and reliable. However, users should independently evaluate the suitability of and test each product selected for their own applications. Littelfuse products are not designed for, and may not be used in, all applications. Read complete Disclaimer Notice at www.littelfuse.com/disclaimer-electronics.