

Part Number:	MM034202-15	
DESCRIPTION:	Analog MEMS Microphone	
DRAWN	CJ	7/26/2018
CHECKED	C.H.	8/16/2018
APPROVED	C.E.	8/16/2018
This document contains data proprietary to DB Unlimited. Any use or reproduction, in any form, without prior written permission of DB Unlimited is prohibited. All terms and conditions can be found at www.dbunlimitedco.com		

Top View

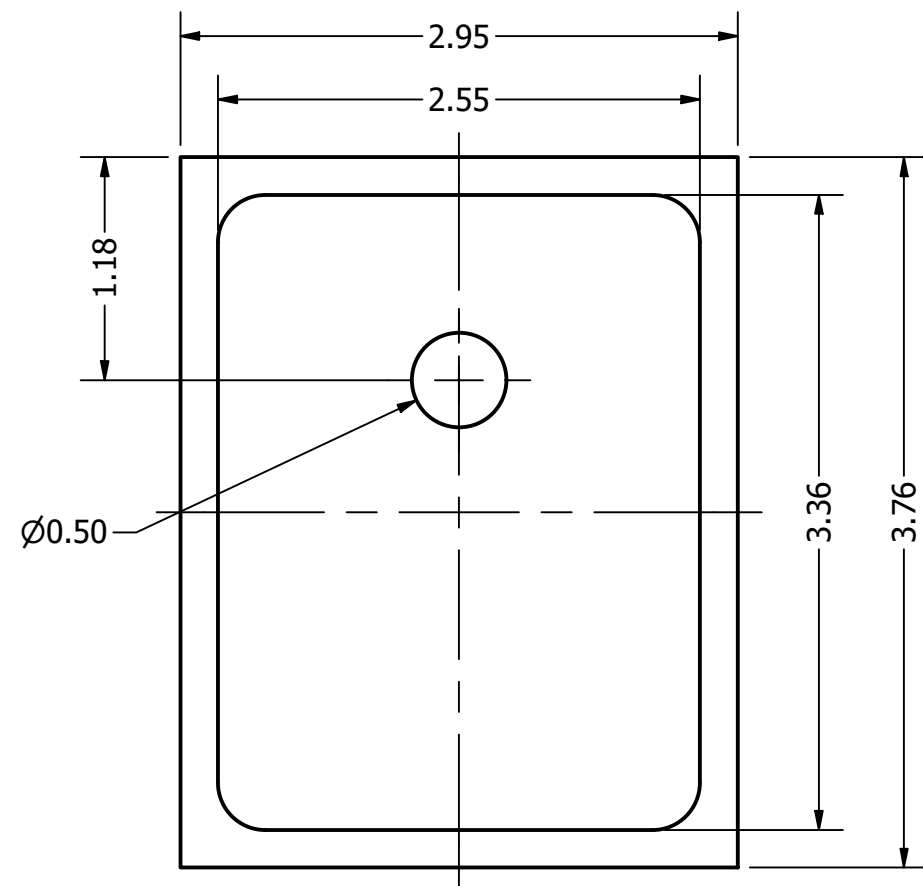

Side View

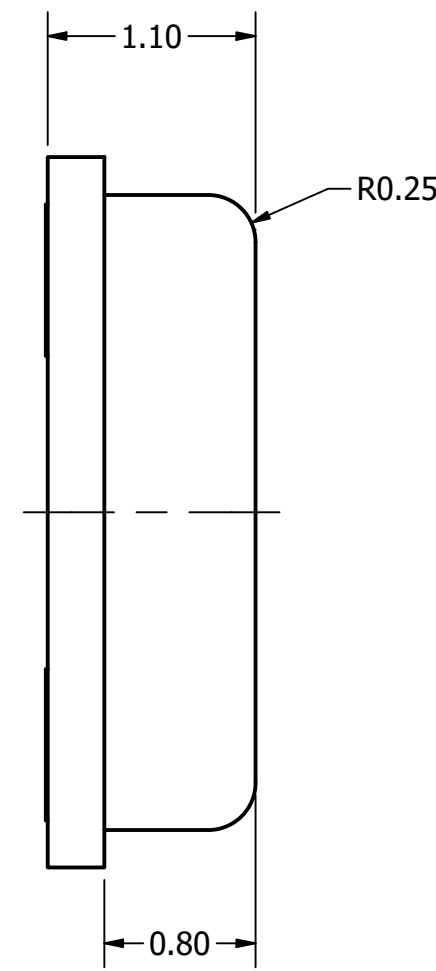

Bottom View

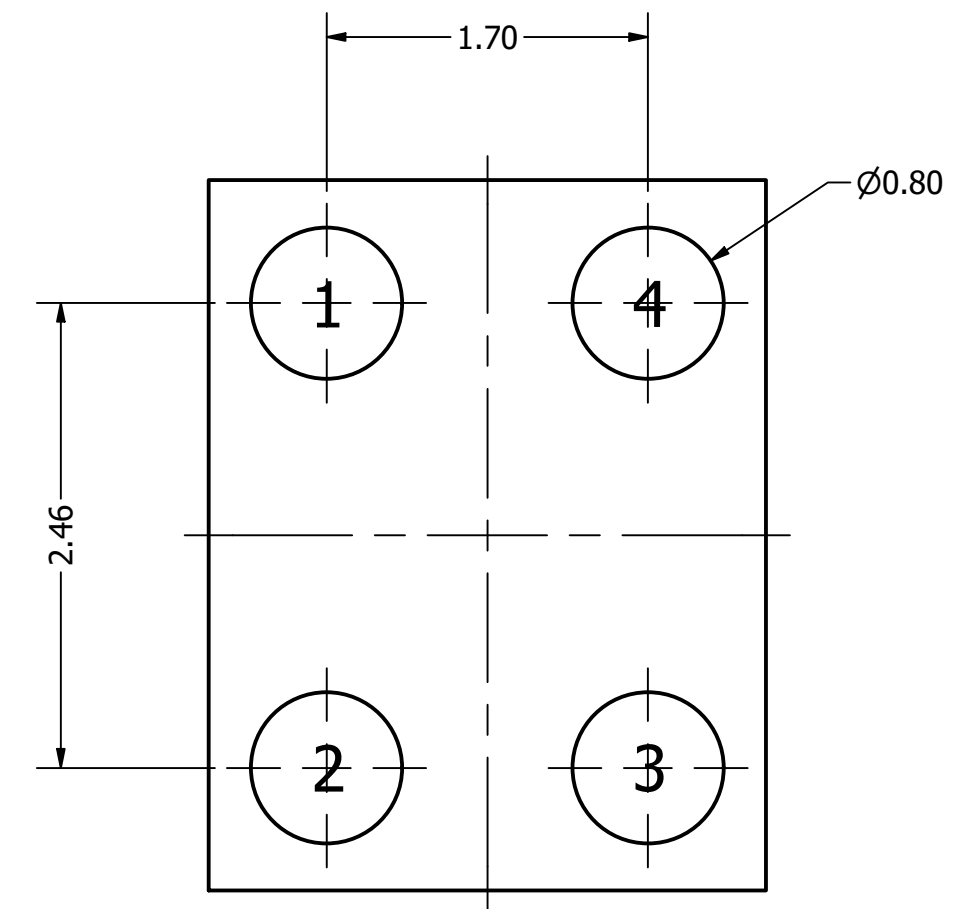

Pin 1	Pin 2	Pin 3	Pin 4
VDD	GND	GND	OUTPUT

Items	Specifications	Conditions
Directivity	Omnidirectional	
Sensitivity	-42 ± 1	dB
Frequency Range	30 ~ 10,000	Hz
Rated Voltage	2	V
Voltage Range	1.6 ~ 3.6	V
Output Impedance	300	Ω
Max. Rated Current	0.1	mA
Power Supply Rejection	-90	dB
Storage Temperature	-40 ~ +105	°C
Operating Temperature	-40 ~ +105	°C
Signal to Noise Ratio	60	dB
Mount Type	Surface Mount	
Connection Method	Surface Mount Pads	

REVISION HISTORY

REV	DESCRIPTION	DATE	APPROVED
	Released from Engineering	8/16/2018	C.E.

NOTES

- 1) All dimensions are in mm unless otherwise noted
- 2) All tolerances are ± 0.1 mm unless otherwise noted
- 3) All parts meet RoHS
- 4) Subject to change or redrawn without notice