

THIS DOCUMENT IS THE PROPERTY OF
KEYSTONE ELECTRONICS CORP. AND
SHALL NOT BE REPRODUCED, DISTRIBUTED
OR USED AS A BASIS FOR MANUFACTURE
WITHOUT PRIOR WRITTEN PERMISSION
FROM KEYSTONE ELECTRONICS CORP.

ACTUAL SIZE

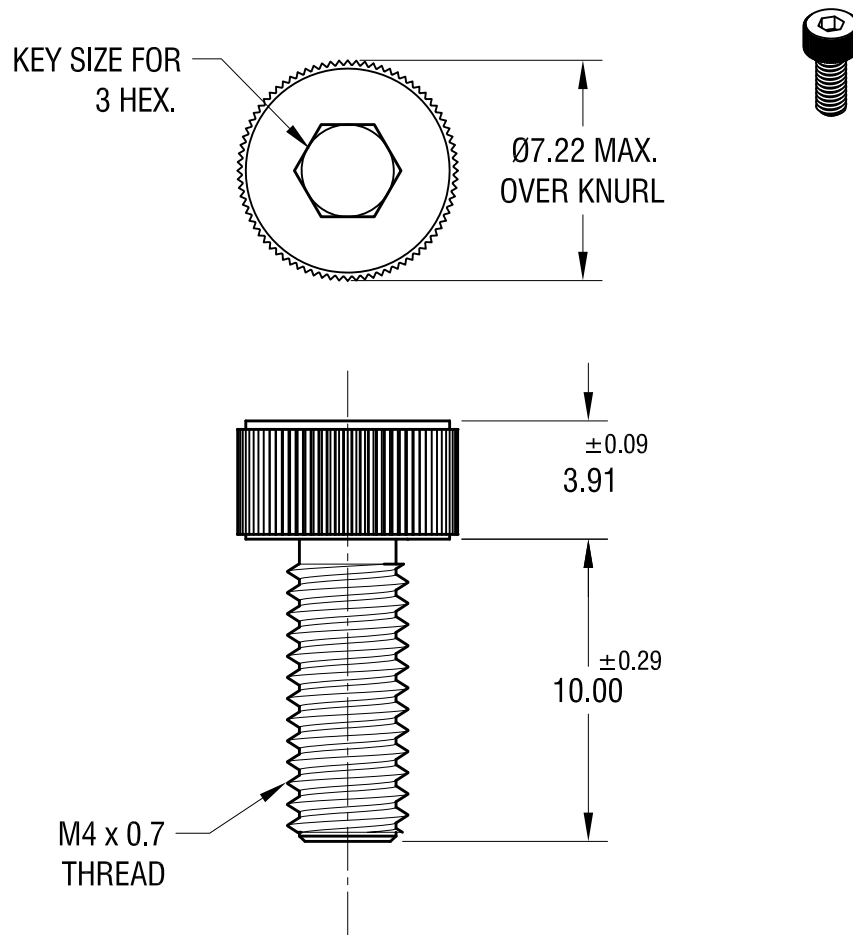

NOTE:

1. ALL DIMENSIONS ARE IN MILLIMETERS

KEYSTONE ELECTRONICS CORP.			
www.keyelco.com • NEW HYDE PARK, NY 11040 • Tel (516) 328-7500			
PART NAME		SOCKET HEAD SCREW	
MATERIAL		TITANIUM, GRADE 2	
FINISH	NONE	DRN BY	NT
		DATE	10.31.19
		APP'D	RH
		SCALE	4X
TOLERANCES	INCH [MM]	CODE	DWG NO.
DECIMAL	± [± 0.13]	C	25041
ANGULAR	± 1°		
UNLESS OTHERWISE SPECIFIED			

DATE	DESCRIPTION	REV.
------	-------------	------