

EHW007A0B Series Eighth-Brick Power Modules

36–75Vdc Input; 12.0Vdc Output; 7A Output Current



RoHS Compliant

Applications

- Distributed Power Architectures
- Wireless Networks
- Access and Optical Network Equipment
- Enterprise Networks including Power over Ethernet (PoE)

Options

- Negative Remote On/Off logic
- Over current/Over temperature/Over voltage protections (Auto-restart)
- Heat plate version (-H)
- Surface Mount version (-S)

Description

The EHW007A0B, Eighth-brick low-height power module is an isolated dc-dc converters that can deliver up to 7A of output current and provide a precisely regulated output voltage of 12.0V over a wide range of input voltages ($V_{IN} = 36 - 75Vdc$). The modules achieve typical full load efficiency of 92.5%. The open frame modules construction, available in both surface-mount and through-hole packaging, enable designers to develop cost and space efficient solutions. Standard features include remote On/Off, remote sense, output voltage adjustment, overvoltage, overcurrent and overtemperature protection.

Features

- Compliant to RoHS EU Directive 2011/65/EU (Z versions)
- Compliant to RoHS EU Directive 2011/65/EU under exemption 7b (Lead solder exemption). Exemption 7b will expire after June 1, 2016 at which time this product will no longer be RoHS compliant (non-Z versions)
- Compliant to ROHS EU Directive 2002/95/EC with lead solder exemption (non-Z versions)
- High efficiency 92.5% at 12.0V full load ($V_{in}=48Vdc$)
- Industry standard, DOSA compliant footprint 58.4mm x 22.8mm x 8.1mm (2.30 in x 0.9 in x 0.32 in)
- Low profile height and reduced component skyline
- Wide input voltage range: 36-75 Vdc
- Tightly regulated output
- Constant switching frequency
- Positive remote On/Off logic
- Input under/over voltage protection
- Output overcurrent and overvoltage protection
- Over-temperature protection
- Remote sense
- No reverse current during output shutdown
- Output Voltage adjust: 90% to 110% of $V_{o,nom}$
- Wide operating temperature range (-40°C to 85°C)
- Suitable for cold wall cooling using suitable Gap Pad applied directly to top side of module
- UL*Recognized to UL60950-1, CAN/CSA† C22.2 No.60950-1, and EN60950-1(VDE ‡ 0805-1) Licensed
- CE mark meets 2006/95/EC directive§
- Meets the voltage and current requirements for ETSI 300-132-2 and complies with and licensed for Basic insulation rating per EN60950-1
- 2250 Vdc Isolation tested in compliance with IEEE 802.3[®] PoE standards
- ISO**9001 and ISO 14001 certified manufacturing facilities



EHW007A0B Series Eighth-Brick Power Modules

36–75Vdc Input; 12.0Vdc Output; 7A Output Current

Absolute Maximum Ratings

Stresses in excess of the absolute maximum ratings can cause permanent damage to the device. These are absolute stress ratings only, functional operation of the device is not implied at these or any other conditions in excess of those given in the operations sections of the data sheet. Exposure to absolute maximum ratings for extended periods can adversely affect the device reliability.

Parameter	Device	Symbol	Min	Max	Unit
Input Voltage					
Continuous	All	V_{IN}	-0.3	80	V _{dc}
Transient, operational (≤ 100 ms)	All	$V_{IN,trans}$	-0.3	100	V _{dc}
Operating Ambient Temperature (see Thermal Considerations section)	All	T_A	-40	85	°C
Storage Temperature	All	T_{stg}	-55	125	°C
I/O Isolation voltage (100% factory Hi-Pot tested)	All	—	—	2250	V _{dc}

Electrical Specifications

Unless otherwise indicated, specifications apply over all operating input voltage, resistive load, and temperature conditions.

Parameter	Device	Symbol	Min	Typ	Max	Unit
Operating Input Voltage	All	V_{IN}	36	48	75	V _{dc}
Maximum Input Current ($V_{IN} = V_{IN,min}$ to $V_{IN,max}$, $I_O = I_{O,max}$)	All	$I_{IN,max}$		2.75	3.0	A _{dc}
Input No Load Current ($V_{IN} = V_{IN,nom}$, $I_O = 0$, module enabled)	All	$I_{IN,No\ load}$		70		mA
Input Stand-by Current ($V_{IN} = V_{IN,nom}$, module disabled)	All	$I_{IN,stand-by}$		5	8	mA
Inrush Transient	All	I^2t			0.5	A ² s
Input Reflected Ripple Current, peak-to-peak (5Hz to 20MHz, 1 μ H source impedance; $V_{IN,min}$ to $V_{IN,max}$, $I_O = I_{O,max}$; See Test configuration section)	All			30		mA _{p-p}
Input Ripple Rejection (120Hz)	All			50		dB

CAUTION: This power module is not internally fused. An input line fuse must always be used.

This power module can be used in a wide variety of applications, ranging from simple standalone operation to an integrated part of sophisticated power architectures. To preserve maximum flexibility, internal fusing is not included, however, to achieve maximum safety and system protection, always use an input line fuse. The safety agencies require a fast-acting fuse with a maximum rating of 6 A (see Safety Considerations section). Based on the information provided in this data sheet on inrush energy and maximum dc input current, the same type of fuse with a lower rating can be used. Refer to the fuse manufacturer's data sheet for further information.

EHW007A0B Series Eighth-Brick Power Modules

36–75Vdc Input; 12.0Vdc Output; 7A Output Current

Electrical Specifications (continued)

Parameter	Device	Symbol	Min	Typ	Max	Unit
Nominal Output Voltage Set-point $V_{IN}=V_{IN,min}$, $I_o=I_{o,max}$, $T_A=25^\circ\text{C}$	All	$V_{o,set}$	11.8	12.0	12.24	V _{dc}
Output Voltage (Over all operating input voltage, resistive load, and temperature conditions until end of life)	All	V_o	11.64	—	12.36	% $V_{o,set}$
Output Regulation						
Line ($V_{IN}=V_{IN,min}$ to $V_{IN,max}$)	All		—	—	±0.2	% $V_{o,set}$
Load ($I_o=I_{o,min}$ to $I_{o,max}$)	All		—	—	±0.2	% $V_{o,set}$
Temperature ($T_{ref}=T_{A,min}$ to $T_{A,max}$)	All		—	—	±1.0	% $V_{o,set}$
Output Ripple and Noise on nominal output ($V_{IN}=V_{IN,nom}$, $I_o=I_{o,max}$, $T_A=T_{A,min}$ to $T_{A,max}$)						
RMS (5Hz to 20MHz bandwidth)	All		—	20	30	mV _{rms}
Peak-to-Peak (5Hz to 20MHz bandwidth)	All		—	50	100	mV _{pk-pk}
External Capacitance	All	$C_{o,max}$	0	—	2,000	μF
Output Current	All	I_o	0	—	7	A _{dc}
Output Current Limit Inception (Hiccup Mode) ($V_o=90\%$ of $V_{o,set}$)	All	$I_{o,lim}$	105	120	130	% I_o
Output Short-Circuit Current ($V_o \leq 250\text{mV}$) (Hiccup Mode)	All	$I_{o,s/c}$		5		A _{rms}
Efficiency						
$V_{IN}=V_{IN,nom}$, $T_A=25^\circ\text{C}$, $I_o=I_{o,max}$, $V_o=V_{o,set}$	All	η		92.5		%
$V_{IN}=V_{IN,nom}$, $T_A=25^\circ\text{C}$, $I_o=0.5I_{o,max}$, $V_o=V_{o,set}$	All	η		91.5		%
Switching Frequency	All	f_{sw}		400		kHz
Dynamic Load Response						
($dI_o/dt=0.1\text{A}/\mu\text{s}$; $V_{IN}=V_{IN,nom}$; $T_A=25^\circ\text{C}$)						
Load Change from $I_o=50\%$ to 75% or 25% to 50% of $I_{o,max}$						
Peak Deviation	All	V_{pk}	—	3	—	% $V_{o,set}$
Settling Time ($V_o < 10\%$ peak deviation)	All	t_s	—	200	—	μs
($dI_o/dt=1.0\text{A}/\mu\text{s}$; $V_{IN}=V_{IN,nom}$; $T_A=25^\circ\text{C}$)						
Load Change from $I_o=50\%$ to 75% or 25% to 50% of $I_{o,max}$						
Peak Deviation	All	V_{pk}	—	5	—	% $V_{o,set}$
Settling Time ($V_o < 10\%$ peak deviation)	All	t_s	—	200	—	μs

Isolation Specifications

Parameter	Device	Symbol	Min	Typ	Max	Unit
Isolation Capacitance	All	C_{iso}	—	1000	—	pF
Isolation Resistance	All	R_{iso}	100	—	—	MΩ
I/O Isolation Voltage (100% factory Hi-pot tested)	All	All	—	—	2250	V _{dc}

General Specifications

Parameter	Device	Symbol	Min	Typ	Max	Unit
Calculated Reliability based upon Telcordia SR-332 Issue 2: Method I Case 3 ($I_o=80\%I_{o,max}$, $T_A=40^\circ\text{C}$, airflow = 200 lfm, 90% confidence)	All	FIT		235.0		10 ⁹ /Hours
	All	MTBF		4,254,493		Hours
Weight (Open Frame)	All			21 (0.77)		g (oz.)
Weight (with Heatplate)	All			33 (1.16)		g (oz.)

EHW007A0B Series Eighth-Brick Power Modules

36–75Vdc Input; 12.0Vdc Output; 7A Output Current

Feature Specifications

Unless otherwise indicated, specifications apply over all operating input voltage, resistive load, and temperature conditions. See Feature Descriptions for additional information.

Parameter	Device	Symbol	Min	Typ	Max	Unit
Remote On/Off Signal Interface ($V_{IN}=V_{IN, min}$ to $V_{IN, max}$; open collector or equivalent, Signal referenced to V_{IN} -terminal) Negative Logic: device code suffix "1" Logic Low = module On, Logic High = module Off Positive Logic: No device code suffix required Logic Low = module Off, Logic High = module On Logic Low - Remote On/Off Current Logic Low - On/Off Voltage Logic High Voltage - (Typ = Open Collector) Logic High maximum allowable leakage current	All	$I_{on/off}$	—	0.3	1.0	mA
	All	$V_{on/off}$	-0.7	—	1.2	V _{dc}
	All	$V_{on/off}$	—	5	—	V _{dc}
	All	$I_{on/off}$	—	—	10	μA
Turn-On Delay and Rise Times ($I_O=I_{O, max}$, $V_{IN}=V_{IN, nom}$, $T_A = 25^\circ\text{C}$) Case 1: Input power is applied for at least 1 second and then the On/Off input is set from OFF to ON ($T_{delay} =$ from instant at which $V_{IN}=V_{IN, min}$ until $V_O = 10\%$ of $V_{O, set}$). Case 2: On/Off input is set to Logic Low (Module ON) and then input power is applied (T_{delay} from instant at which $V_{IN} = V_{IN, min}$ until $V_O=10\%$ of $V_{O, set}$) Output voltage Rise time (time for V_O to rise from 10% of $V_{O, set}$ to 90% of $V_{O, set}$)	All	T_{delay}	—	20	—	msec
	All	T_{delay}	—	—	150	msec
	All	T_{rise}	—	5	12	msec
Output voltage overshoot – Startup $I_O= I_{O, max}$; $V_{IN}=V_{IN, min}$ to $V_{IN, max}$, $T_A = 25^\circ\text{C}$	All			—	3	% $V_{O, set}$
Remote Sense Range	All	V_{SENSE}			10	% $V_{O, set}$
Output Voltage Adjustment Range	All		90		110	% $V_{O, set}$
Output Overvoltage Protection	All	$V_{O, limit}$	13.8	—	16.5	V _{dc}
Overtemperature Protection – Hiccup Auto Restart	All	T_{ref}	—	135	—	°C
Input Undervoltage Lockout Turn-on Threshold Turn-off Threshold Hysteresis	All	V_{UVLO}	— 30 1	34 32 2	36 — 3	V _{dc} V _{dc} V _{dc}
Input Overvoltage Lockout Turn-on Threshold Turn-off Threshold Hysteresis	All	V_{OVLO}	76 — 1	79 81 2	— 83 —	V _{dc} V _{dc} V _{dc}

EHW007A0B Series Eighth-Brick Power Modules

36–75Vdc Input; 12.0Vdc Output; 7A Output Current

Characteristic Curves

The following figures provide typical characteristics for the EHW007A0B (12.0V, 7A) at 25°C. The figures are identical for either positive or negative remote On/Off logic.

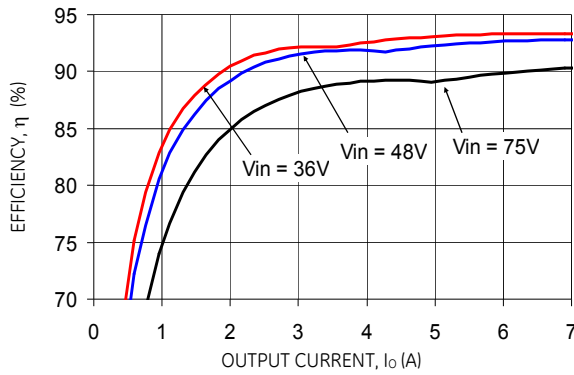

Figure 1. Converter Efficiency versus Output Current.

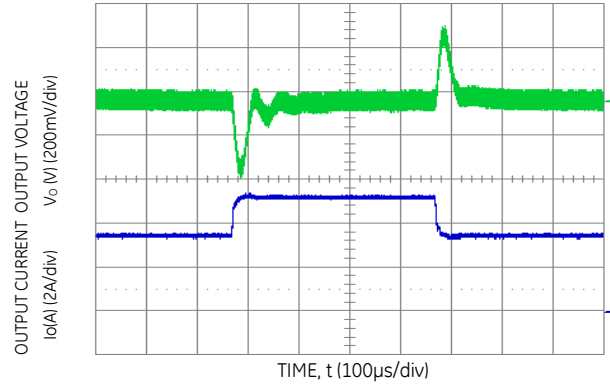

Figure 4. Transient Response to 1.0A/ μ s Dynamic Load Change from 50% to 75% to 50% of full load.

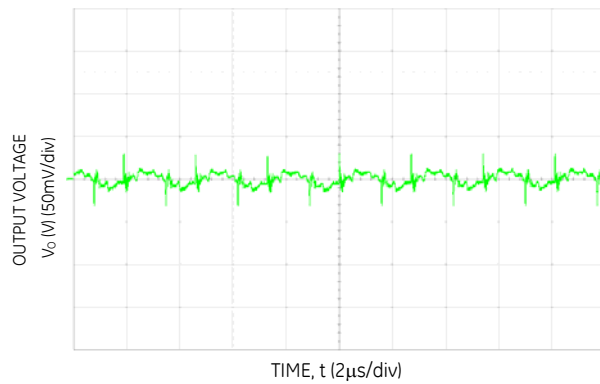

Figure 2. Typical output ripple and noise ($V_{IN} = V_{IN,NOM}$, $I_o = I_{o,max}$).

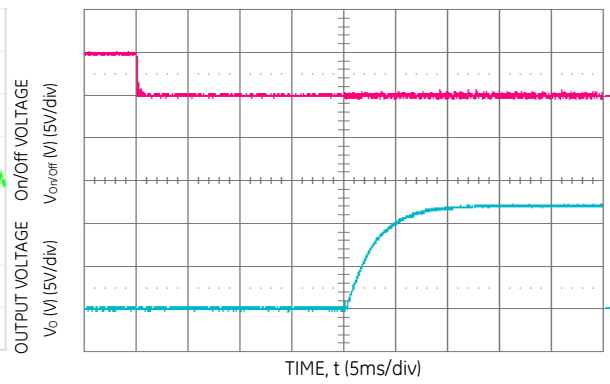

Figure 5. Typical Start-up Using Remote On/Off, negative logic version shown ($V_{IN} = V_{IN,NOM}$, $I_o = I_{o,max}$).

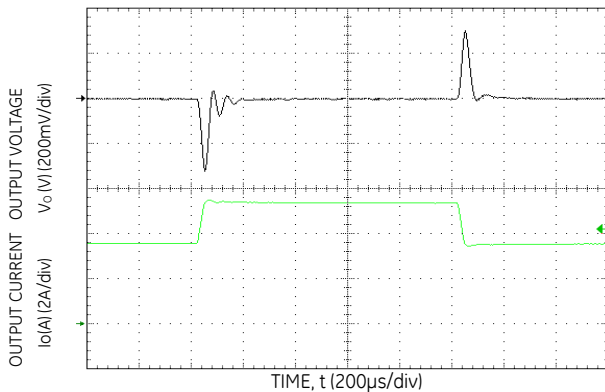

Figure 3. Transient Response to 0.1A/ μ s Dynamic Load Change from 50% to 75% to 50% of full load.

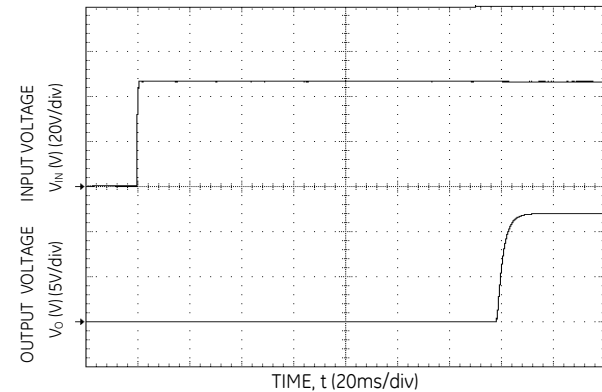
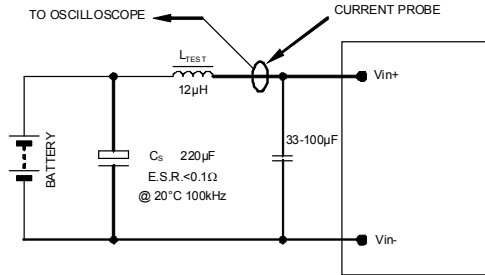

Figure 6. Typical Start-up Using Input Voltage ($V_{IN} = V_{IN,NOM}$, $I_o = I_{o,max}$).

EHW007A0B Series Eighth-Brick Power Modules

36–75Vdc Input; 12.0Vdc Output; 7A Output Current

Test Configurations



NOTE: Measure input reflected ripple current with a simulated source inductance (L_{TEST}) of 12µH. Capacitor C_s offsets possible battery impedance. Measure current as shown above.

Figure 7. Input Reflected Ripple Current Test Setup.

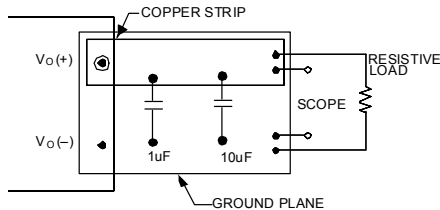

NOTE: All voltage measurements to be taken at the module terminals, as shown above. If sockets are used then Kelvin connections are required at the module terminals to avoid measurement errors due to socket contact resistance.

Figure 8. Output Ripple and Noise Test Setup.

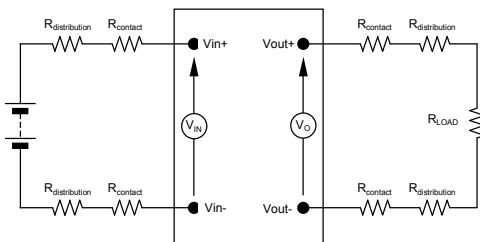

NOTE: All voltage measurements to be taken at the module terminals, as shown above. If sockets are used then Kelvin connections are required at the module terminals to avoid measurement errors due to socket contact resistance.

Figure 9. Output Voltage and Efficiency Test Setup.

$$\text{Efficiency } \eta = \frac{V_O \cdot I_O}{V_{IN} \cdot I_{IN}} \times 100 \%$$

Design Considerations

Input Filtering

The power module should be connected to a low ac-impedance source. Highly inductive source impedance can affect the stability of the power module. For the test configuration in Figure 7 a 33-100µF electrolytic capacitor (ESR<0.7Ω at 100kHz), mounted close to the power module helps ensure the stability of the unit. Consult the factory for further application guidelines.

Safety Considerations

For safety-agency approval of the system in which the power module is used, the power module must be installed in compliance with the spacing and separation requirements of the end-use safety agency standard, i.e. UL60950-1, CSA C22.2 No.60950-1, and VDE0805-1(IEC60950-1).

If the input source is non-SELV (ELV or a hazardous voltage greater than 60 Vdc and less than or equal to 75Vdc), for the module's output to be considered as meeting the requirements for safety extra-low voltage (SELV), all of the following must be true:

- The input source is to be provided with reinforced insulation from any other hazardous voltages, including the ac mains.
- One V_{IN} pin and one V_{OUT} pin are to be grounded, or both the input and output pins are to be kept floating.
- The input pins of the module are not operator accessible.
- Another SELV reliability test is conducted on the whole system (combination of supply source and subject module), as required by the safety agencies, to verify that under a single fault, hazardous voltages do not appear at the module's output.

Note: Do not ground either of the input pins of the module without grounding one of the output pins. This may allow a non-SELV voltage to appear between the output pins and ground.

The power module has extra-low voltage (ELV) outputs when all inputs are ELV.

All flammable materials used in the manufacturing of these modules are rated 94V-0, or tested to the UL60950 A.2 for reduced thickness.

For input voltages exceeding -60 Vdc but less than or equal to -75 Vdc, these converters have been evaluated to the applicable requirements of BASIC INSULATION between secondary DC MAINS DISTRIBUTION input (classified as TNV-2 in Europe) and unearthed SELV outputs.

The input to these units is to be provided with a maximum 6 A fast-acting fuse in the ungrounded lead.

EHW007A0B Series Eighth-Brick Power Modules

36–75Vdc Input; 12.0Vdc Output; 7A Output Current

Feature Description

Remote On/Off

Two remote on/off options are available. Positive logic turns the module on during a logic high voltage on the ON/OFF pin, and off during a logic low. Negative logic remote On/Off, device code suffix "1", turns the module off during a logic high and on during a logic low.

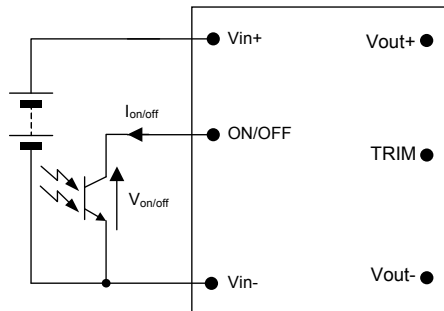

Figure 10. Remote On/Off Implementation.

To turn the power module on and off, the user must supply a switch (open collector or equivalent) to control the voltage ($V_{on/off}$) between the ON/OFF terminal and the $V_{IN(-)}$ terminal (see Figure 10). Logic low is $0V \leq V_{on/off} \leq 1.2V$. The maximum $I_{on/off}$ during a logic low is 1mA, the switch should be maintain a logic low level whilst sinking this current.

During a logic high, the typical maximum $V_{on/off}$ generated by the module is 5V, and the maximum allowable leakage current at $V_{on/off} = 5V$ is $1\mu A$.

If not using the remote on/off feature:

For positive logic, leave the ON/OFF pin open.

For negative logic, short the ON/OFF pin to $V_{IN(-)}$.

Remote Sense

Remote sense minimizes the effects of distribution losses by regulating the voltage at the remote-sense connections (See Figure 11). The voltage between the remote-sense pins and the output terminals must not exceed the output voltage sense range given in the Feature Specifications table:

$$[V_o(+)-V_o(-)] - [SENSE(+)-SENSE(-)] \leq 0.5V$$

Although the output voltage can be increased by both the remote sense and by the trim, the maximum increase for the output voltage is not the sum of both. The maximum increase is the larger of either the remote sense or the trim.

The amount of power delivered by the module is defined as the voltage at the output terminals multiplied by the output current. When using remote sense and trim, the output voltage of the module can be increased, which at the same output current would increase the power output of the module. Care should be taken to ensure

that the maximum output power of the module remains at or below the maximum rated power (Maximum rated power = $V_o,set \times I_o,max$).

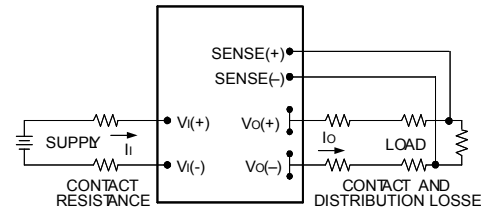

Figure 11. Circuit Configuration for remote sense .

Input Undervoltage Lockout

At input voltages below the input undervoltage lockout limit, the module operation is disabled. The module will only begin to operate once the input voltage is raised above the undervoltage lockout turn-on threshold, $V_{UV/ON}$.

Once operating, the module will continue to operate until the input voltage is taken below the undervoltage turn-off threshold, $V_{UV/OFF}$.

Overtemperature Protection

To provide protection under certain fault conditions, the unit is equipped with a thermal shutdown circuit. The unit will shutdown if the thermal reference point T_{ref} (Figure 13), exceeds $135^{\circ}C$ (typical), but the thermal shutdown is not intended as a guarantee that the unit will survive temperatures beyond its rating. The module can be restarted by cycling the dc input power for at least one second or by toggling the remote on/off signal for at least one second. If the auto-restart option (4) is ordered, the module will automatically restart upon cool-down to a safe temperature.

Output Overvoltage Protection

The output over voltage protection scheme of the modules has an independent over voltage loop to prevent single point of failure. This protection feature latches in the event of over voltage across the output. Cycling the on/off pin or input voltage resets the latching protection feature. If the auto-restart option (4) is ordered, the module will automatically restart upon an internally programmed time elapsing.

Overcurrent Protection

To provide protection in a fault (output overload) condition, the unit is equipped with internal current-limiting circuitry and can endure current limiting continuously. At the point of current-limit inception, the unit enters hiccup mode. If the unit is not configured with auto-restart, then it will latch off following the over current condition. The module can be restarted by cycling the dc input power for at least

EHW007A0B Series Eighth-Brick Power Modules

36–75Vdc Input; 12.0Vdc Output; 7A Output Current

Feature Descriptions (continued)

one second or by toggling the remote on/off signal for at least one second. If the unit is configured with the auto-restart option (4), it will remain in the hiccup mode as long as the overcurrent condition exists; it operates normally, once the output current is brought back into its specified range. The average output current during hiccup is 10% $I_{o,max}$.

Output Voltage Programming

Trimming allows the output voltage set point to be increased or decreased, this is accomplished by connecting an external resistor between the TRIM pin and either the $V_{o}(+)$ pin or the $V_{o}(-)$ pin.

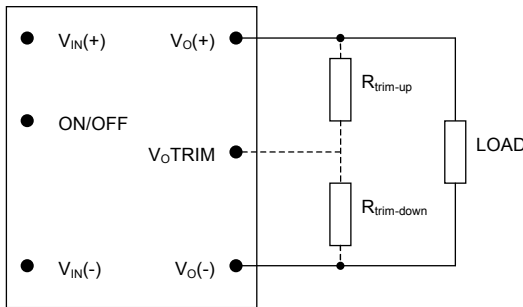

Figure 12. Circuit Configuration to Trim Output Voltage.

Connecting an external resistor ($R_{trim-down}$) between the TRIM pin and the $V_{o}(-)$ (or Sense(-)) pin decreases the output voltage set point. To maintain set point accuracy, the trim resistor tolerance should be $\pm 1.0\%$.

The following equation determines the required external resistor value to obtain a percentage output voltage change of $\Delta\%$

$$R_{trim-down} = \left[\frac{511}{\Delta\%} - 10.22 \right] K\Omega$$

Where $\Delta\% = \left(\frac{V_{o,set} - V_{desired}}{V_{o,set}} \right) \times 100$

For example, to trim-down the output voltage of the module by 8% to 11.04V, $R_{trim-down}$ is calculated as follows:

$$\Delta\% = 8$$

$$R_{trim-down} = \left[\frac{511}{8} - 10.22 \right] K\Omega$$

$$R_{trim-down} = 53.655 K\Omega$$

Connecting an external resistor ($R_{trim-up}$) between the TRIM pin and the $V_{o}(+)$ (or Sense (+)) pin increases the output voltage set point. The following equation determines the required external resistor value to obtain a percentage output voltage change of $\Delta\%$:

$$R_{trim-up} = \left[\frac{5.11 \times V_{o,set} \times (100 + \Delta\%)}{1.225 \times \Delta\%} - \frac{511}{\Delta\%} - 10.22 \right] K\Omega$$

Where $\Delta\% = \left(\frac{V_{desired} - V_{o,set}}{V_{o,set}} \right) \times 100$

For example, to trim-up the output voltage of the module by 5% to 12.6V, $R_{trim-up}$ is calculated as follows:

$$\Delta\% = 5$$

$$R_{trim-up} = \left[\frac{5.11 \times 12.0 \times (100 + 5)}{1.225 \times 5} - \frac{511}{5} - 10.22 \right] K\Omega$$

$$R_{trim-up} = 938.8 K\Omega$$

The voltage between the $V_{o}(+)$ and $V_{o}(-)$ terminals must not exceed the minimum output overvoltage protection value shown in the Feature Specifications table. This limit includes any increase in voltage due to remote-sense compensation and output voltage set-point adjustment trim.

Although the output voltage can be increased by both the remote sense and by the trim, the maximum increase for the output voltage is not the sum of both. The maximum increase is the larger of either the remote sense or the trim. The amount of power delivered by the module is defined as the voltage at the output terminals multiplied by the output current. When using remote sense and trim, the output voltage of the module can be increased, which at the same output current would increase the power output of the module. Care should be taken to ensure that the maximum output power of the module remains at or below the maximum rated power (Maximum rated power = $V_{o,set} \times I_{o,max}$).

Thermal Considerations

The power modules operate in a variety of thermal environments; however, sufficient cooling should be provided to help ensure reliable operation.

Considerations include ambient temperature, airflow, module power dissipation, and the need for increased reliability. A reduction in the operating temperature of the module will result in an increase in reliability. The thermal data presented here is based on physical measurements taken in a wind tunnel.

The thermal reference point, T_{ref} used in the specifications for open frame modules is shown in Figure 13. For reliable operation this temperature should not exceed 123°C.

The thermal reference point, T_{ref} used in the specifications for modules with heatplate is shown in Figure 14. For reliable operation this temperature should not exceed 110°C.

EHW007A0B Series Eighth-Brick Power Modules

36–75Vdc Input; 12.0Vdc Output; 7A Output Current

Thermal Considerations (continued)

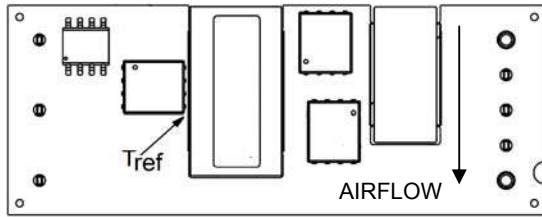

Figure 13. T_{ref} Temperature Measurement Location for Open Frame Module.

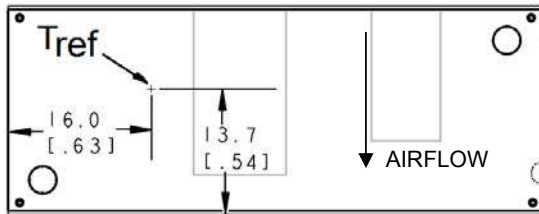

Figure 14. T_{ref} Temperature Measurement Location for Module with Heatplate.

Heat Transfer via Convection

Increased airflow over the module enhances the heat transfer via convection. Derating curves showing the maximum output current that can be delivered by each module versus local ambient temperature (T_A) for natural convection and up to 3m/s (600 ft./min) forced airflow are shown in Figure 14.

Please refer to the Application Note “Thermal Characterization Process For Open-Frame Board-Mounted Power Modules” for a detailed discussion of thermal aspects including maximum device temperatures.

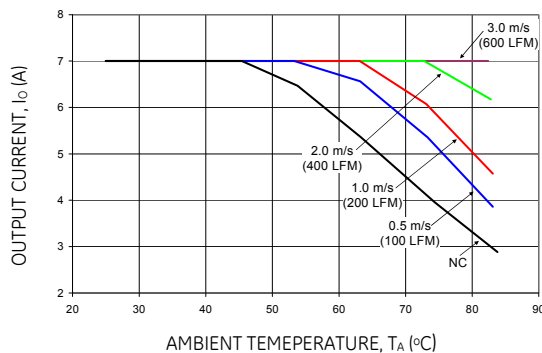

Figure 14. Output Current Derating for the Open Frame Module; Airflow in the Transverse Direction from $V_{out}(+)$ to $V_{out}(-)$; $V_{in} = 48V$.

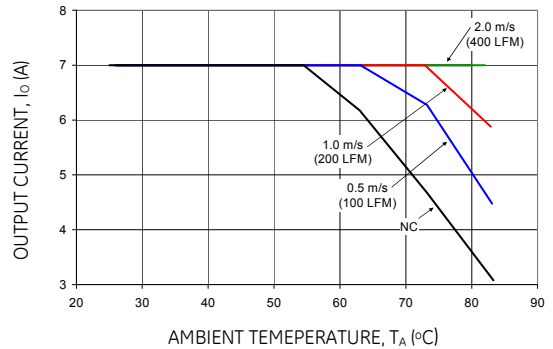

Figure 15. Output Current Derating for the Module with Heatplate; Airflow in the Transverse Direction from $V_{out}(+)$ to $V_{out}(-)$; $V_{in} = 48V$.

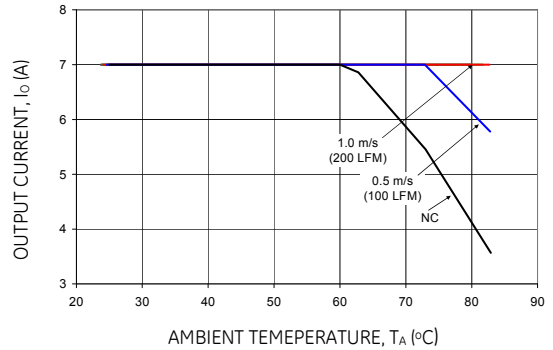

Figure 16. Output Current Derating for the Module with Heatplate and 0.25 in. heat sink; Airflow in the Transverse Direction from $V_{out}(+)$ to $V_{out}(-)$; $V_{in} = 48V$.

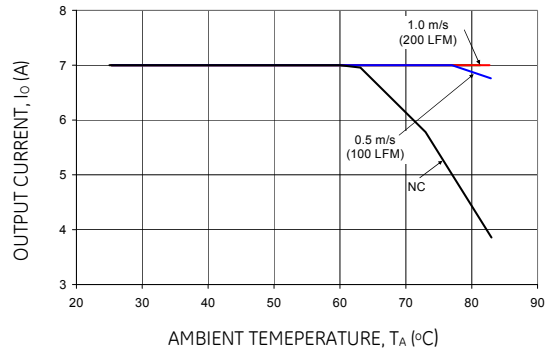

Figure 17. Output Current Derating for the Module with Heatplate and 0.5 in. heat sink; Airflow in the Transverse Direction from $V_{out}(+)$ to $V_{out}(-)$; $V_{in} = 48V$.

EHW007A0B Series Eighth-Brick Power Modules

36–75Vdc Input; 12.0Vdc Output; 7A Output Current

Thermal Considerations (continued)

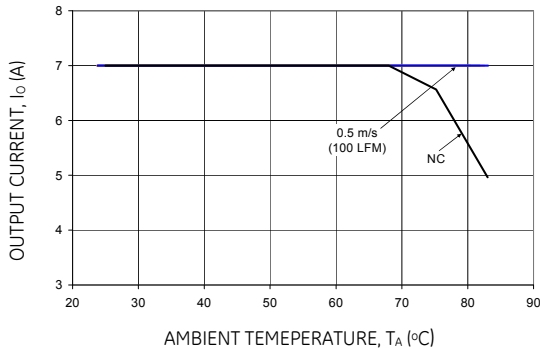

Figure 18. Output Current Derating for the Module with Heatplate and 1.0 in. heat sink; Airflow in the Transverse Direction from Vout(+) to Vout(-); Vin = 48V.

Surface Mount Information

Pick and Place

The EHW007A0B modules use an open frame construction and are designed for a fully automated assembly process. The modules are fitted with a label designed to provide a large surface area for pick and place operations. The label meets all the requirements for surface mount processing, as well as safety standards, and is able to withstand reflow temperatures of up to 300°C. The label also carries product information such as product code, serial number and the location of manufacture.

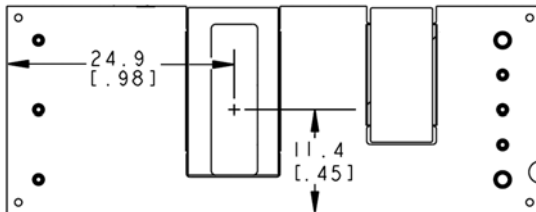

Figure 17. Pick and Place Location.

Nozzle Recommendations

The module weight has been kept to a minimum by using open frame construction. Even so, these modules have a relatively large mass when compared to conventional SMT components. Variables such as nozzle size, tip style, vacuum pressure and placement speed should be considered to optimize this process. The minimum recommended nozzle diameter for reliable operation is 6mm. The maximum nozzle outer diameter, which will safely fit within the allowable component spacing, is 9 mm.

Oblong or oval nozzles up to 11 × 9 mm may also be used within the space available.

Tin Lead Soldering

The EHW007A0B power modules are lead free modules and can be soldered either in a lead-free solder process

or in a conventional Tin/Lead (Sn/Pb) process. It is recommended that the customer review data sheets in order to customize the solder reflow profile for each application board assembly. The following instructions must be observed when soldering these units. Failure to observe these instructions may result in the failure of or cause damage to the modules, and can adversely affect long-term reliability.

In a conventional Tin/Lead (Sn/Pb) solder process peak reflow temperatures are limited to less than 235°C. Typically, the eutectic solder melts at 183°C, wets the land, and subsequently wicks the device connection. Sufficient time must be allowed to fuse the plating on the connection to ensure a reliable solder joint. There are several types of SMT reflow technologies currently used in the industry. These surface mount power modules can be reliably soldered using natural forced convection, IR (radiant infrared), or a combination of convection/IR. For reliable soldering the solder reflow profile should be established by accurately measuring the modules CP connector temperatures.

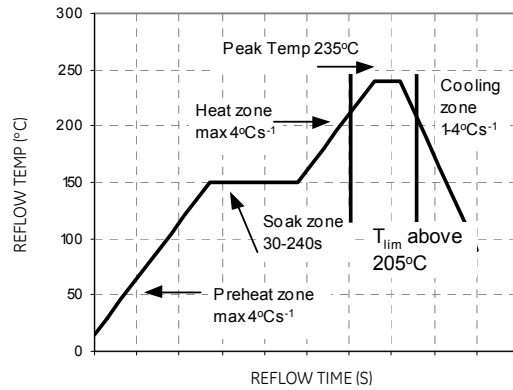

Figure 18. Reflow Profile for Tin/Lead (Sn/Pb) process

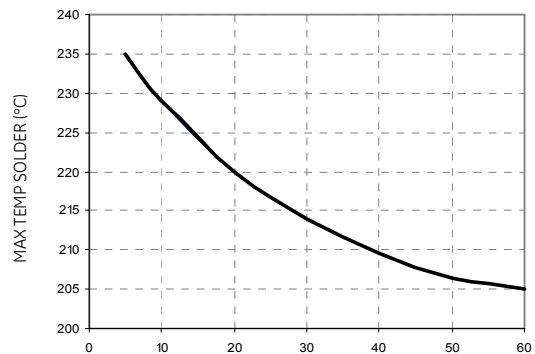

Figure 19. Time Limit Curve Above 205°C for Tin/Lead (Sn/Pb) process

EHW007A0B Series Eighth-Brick Power Modules

36–75Vdc Input; 12.0Vdc Output; 7A Output Current

Surface Mount Information (continued)

Lead Free Soldering

The –Z version of the EHW007A0B modules are lead-free (Pb-free) and RoHS compliant and are both forward and backward compatible in a Pb-free and a SnPb soldering process. Failure to observe the instructions below may result in the failure of or cause damage to the modules and can adversely affect long-term reliability.

Pb-free Reflow Profile

Power Systems will comply with J-STD-020 Rev. C (Moisture/Reflow Sensitivity Classification for Nonhermetic Solid State Surface Mount Devices) for both Pb-free solder profiles and MSL classification procedures. This standard provides a recommended forced-air-convection reflow profile based on the volume and thickness of the package (table 4-2). The suggested Pb-free solder paste is Sn/Ag/Cu (SAC). The recommended linear reflow profile using Sn/Ag/Cu solder is shown in Figure 20.

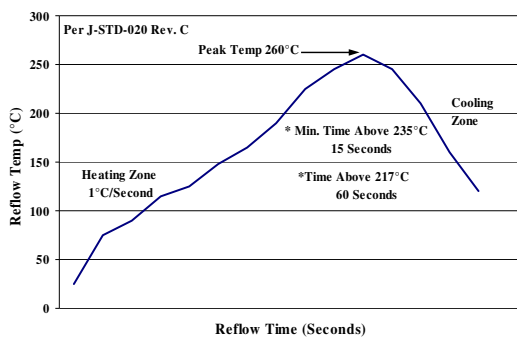

Figure 20. Recommended linear reflow profile using Sn/Ag/Cu solder.

MSL Rating

The EHW007A0B modules have a MSL rating of 2.

Storage and Handling

The recommended storage environment and handling procedures for moisture-sensitive surface mount packages is detailed in J-STD-033 Rev. A (Handling, Packing, Shipping and Use of Moisture/Reflow Sensitive Surface Mount Devices). Moisture barrier bags (MBB) with desiccant are required for MSL ratings of 2 or greater. These sealed packages should not be broken until time of use. Once the original package is broken, the floor life of the product at conditions of $\leq 30^{\circ}\text{C}$ and 60% relative humidity varies according to the MSL rating (see J-STD-033A). The shelf life for dry packed SMT packages will be a minimum of 12 months from the bag

seal date, when stored at the following conditions: $< 40^{\circ}\text{C}$, $< 90\%$ relative humidity.

Post Solder Cleaning and Drying Considerations

Post solder cleaning is usually the final circuit-board assembly process prior to electrical board testing. The result of inadequate cleaning and drying can affect both the reliability of a power module and the testability of the finished circuit-board assembly. For guidance on appropriate soldering, cleaning and drying procedures, refer to *GE Board*

Mounted Power Modules: Soldering and Cleaning Application Note (AN04-001).

Through-Hole Lead-Free Soldering Information

The RoHS-compliant through-hole products use the SAC (Sn/Ag/Cu) Pb-free solder and RoHS-compliant components. They are designed to be processed through single or dual wave soldering machines. The pins have an RoHS-compliant finish that is compatible with both Pb and Pb-free wave soldering processes. A maximum preheat rate of 3°C/s is suggested. The wave preheat process should be such that the temperature of the power module board is kept below 210°C . For Pb solder, the recommended pot temperature is 260°C , while the Pb-free solder pot is 270°C max. Not all RoHS-compliant through-hole products can be processed with paste-through-hole Pb or Pb-free reflow process. If additional information is needed, please consult with your GE representative for more details.

EHW007A0B Series Eighth-Brick Power Modules

36-75Vdc Input; 12.0Vdc Output; 7A Output Current

EMC Considerations

The circuit and plots in Figure 21 shows a suggested configuration to meet the conducted emission limits of EN55022 Class B.

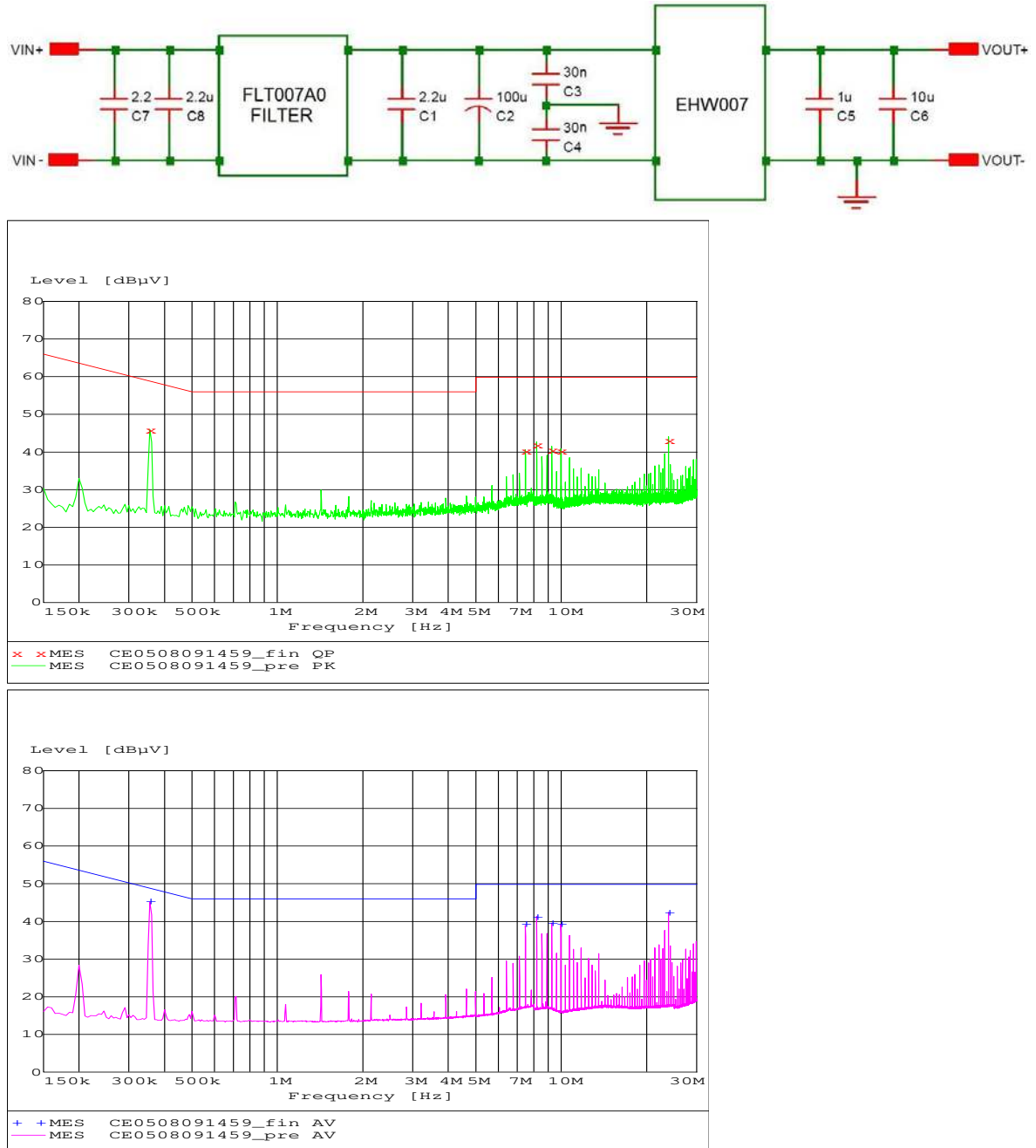

Figure 21. EMC Considerations

For further information on designing for EMC compliance, please refer to the FLT007A0 data sheet (DS05-028).

EHW007A0B Series Eighth-Brick Power Modules

36-75Vdc Input; 12.0Vdc Output; 7A Output Current

Mechanical Outline for Through-Hole Module

Dimensions are in millimeters and [inches].

Tolerances: x.x mm ± 0.5 mm [x.xx in. ± 0.02 in.] (Unless otherwise indicated)

x.xx mm ± 0.25 mm [x.xxx in. ± 0.010 in.]

Top side label includes GE name, product designation and date code.

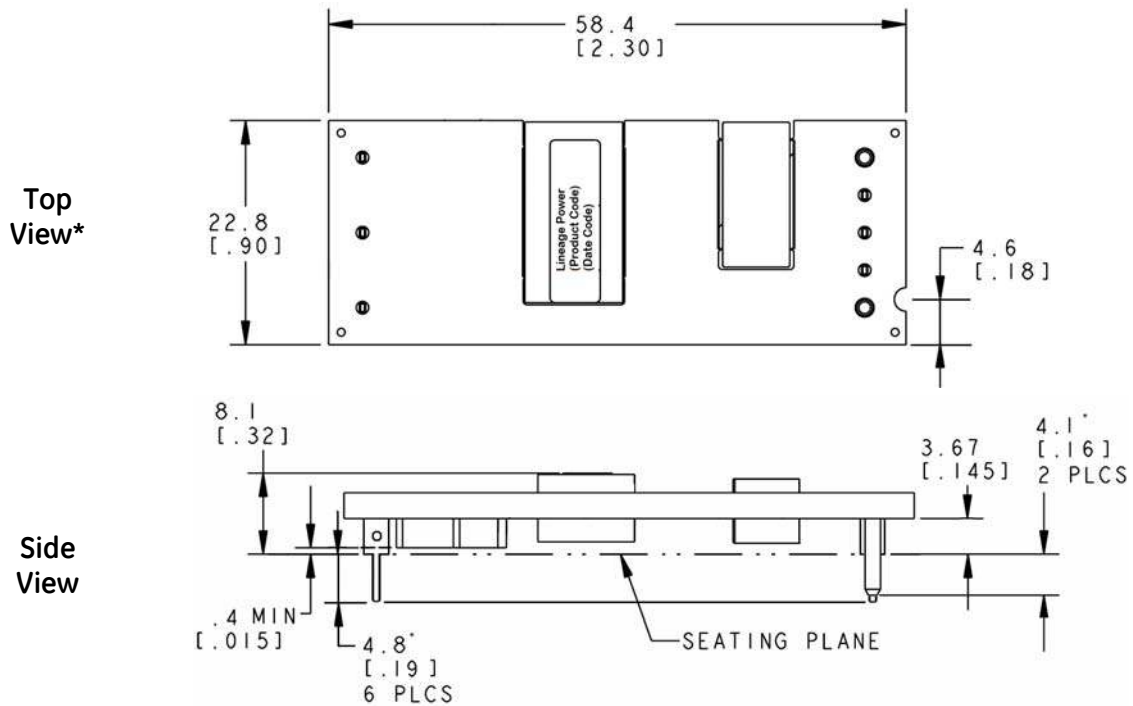

*For optional pin lengths, see Table 2, Device Coding Scheme and Options

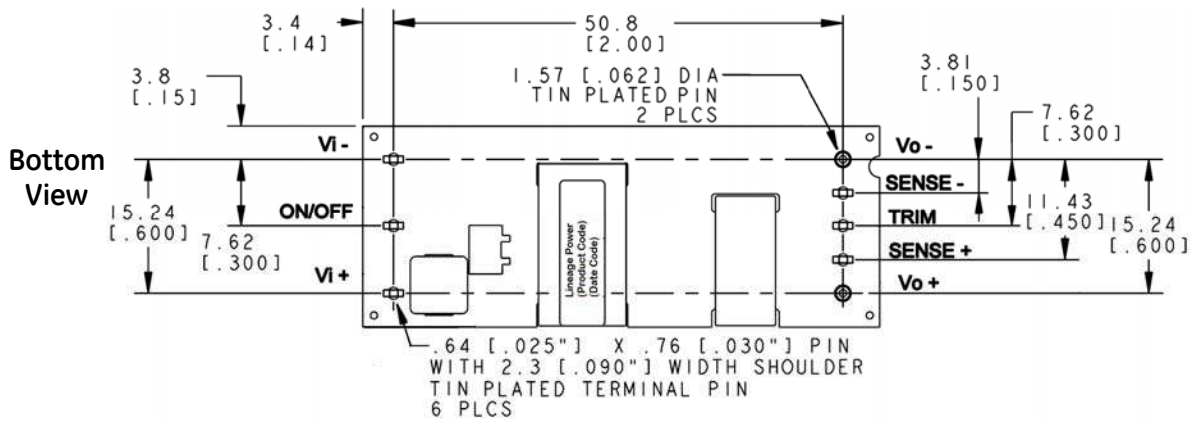

Pin	Function
1	Vi(+)
2	ON/OFF
3	Vi(-)
4	Vo(-)
5	SENSE(-)
6	TRIM
7	SENSE(+)
8	Vo(+)

EHW007A0B Series Eighth-Brick Power Modules

36-75Vdc Input; 12.0Vdc Output; 7A Output Current

Mechanical Outline for Surface Mount Module (-S Option)

Dimensions are in millimeters and [inches].

Tolerances: x.x mm ± 0.5 mm [x.xx in. ± 0.02 in.] (Unless otherwise indicated)

x.xx mm ± 0.25 mm [x.xxx in. ± 0.010 in.]

* Top side label includes GE name, product designation and date code.

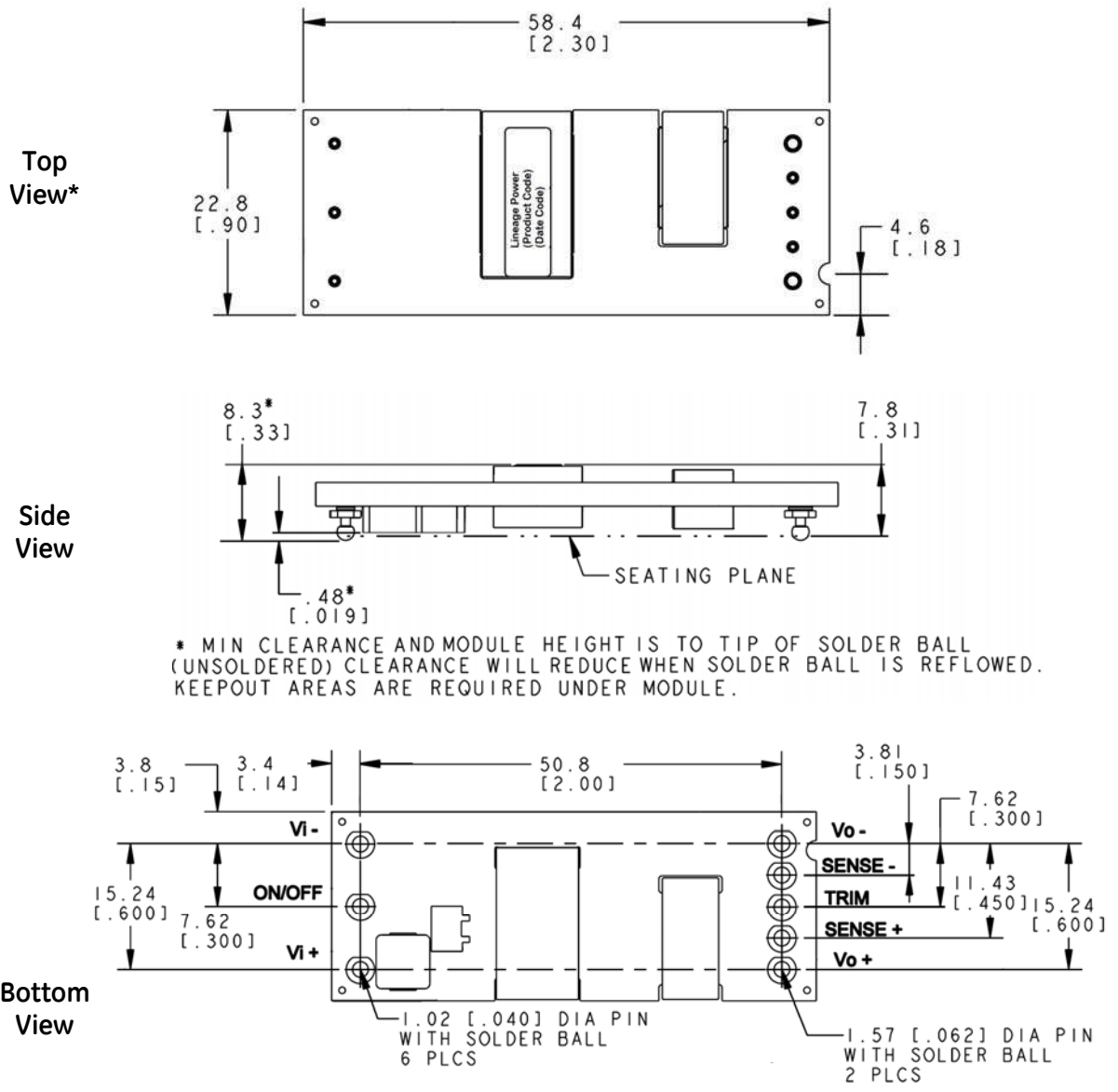

Pin	Function
1	Vi(+)
2	ON/OFF
3	Vi(-)
4	Vo(-)
5	SENSE(-)
6	TRIM
7	SENSE(+)
8	Vo(+)

EHW007A0B Series Eighth-Brick Power Modules

36–75Vdc Input; 12.0Vdc Output; 7A Output Current

Mechanical Outline for Through-Hole Module with Heat Plate (-H Option)

Dimensions are in millimeters and [inches].

Tolerances: x.x mm ± 0.5 mm [x.xx in. ± 0.02 in.] (Unless otherwise indicated)

x.xxx mm ± 0.25 mm [x.xxx in ± 0.010 in.]

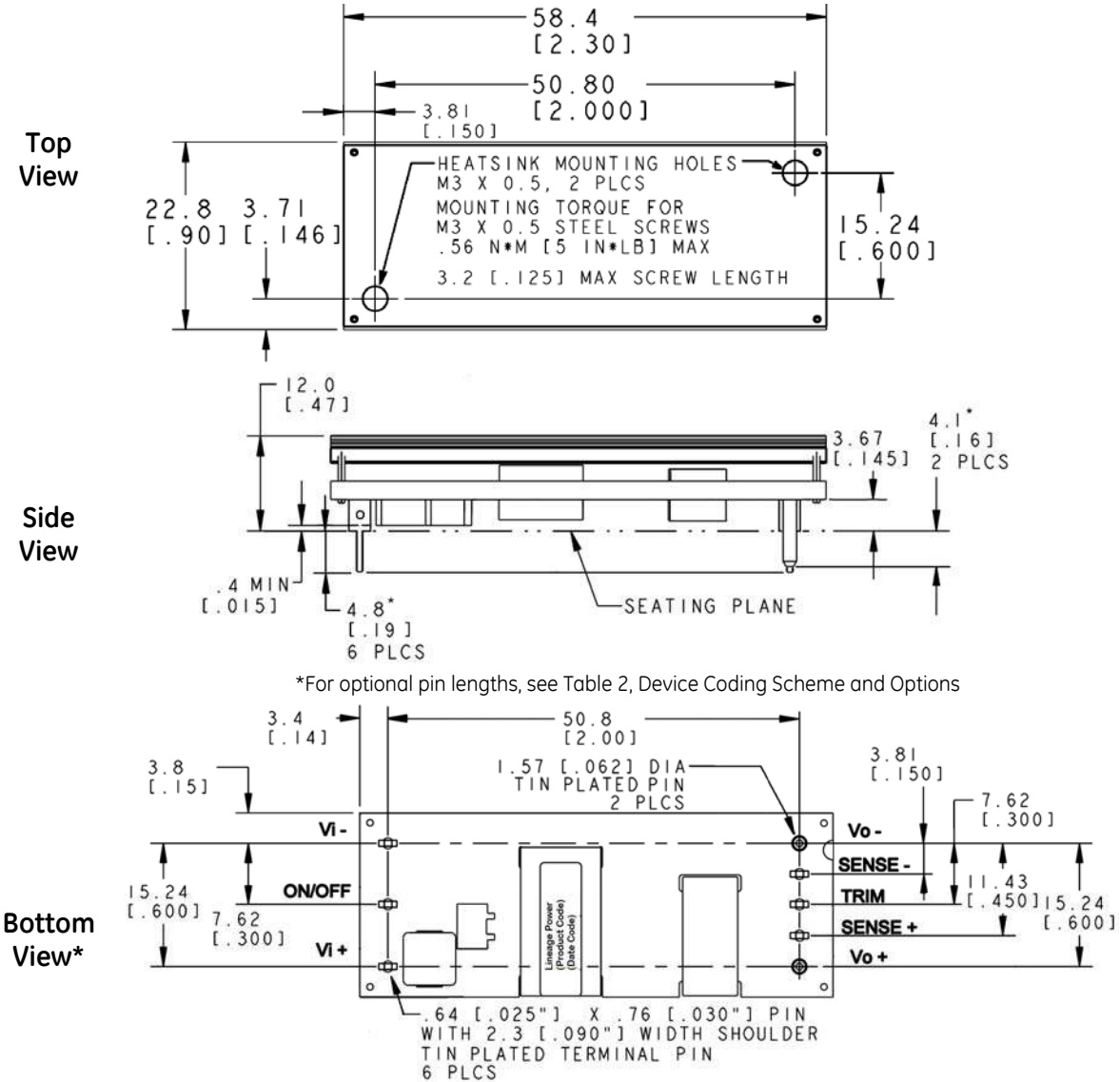

* Bottom side label includes GE name, product designation and date code.

Pin	Function
1	Vi(+)
2	ON/OFF
3	Vi(-)
4	Vo(-)
5	SENSE(-)
6	TRIM
7	SENSE(+)
8	Vo(+)

EHW007A0B Series Eighth-Brick Power Modules

36–75Vdc Input; 12.0Vdc Output; 7A Output Current

Recommended Pad Layout

Dimensions are in millimeters and [inches].

Tolerances: x.x mm ± 0.5 mm [x.xx in. ± 0.02 in.] (Unless otherwise indicated)

x.xxx mm ± 0.25 mm [x.xxx in. ± 0.010 in.]

Pin	Function
1	Vi(+)
2	ON/OFF
3	Vi(-)
4	Vo(-)
5	SENSE(-)
6	TRIM
7	SENSE(+)
8	Vo(+)

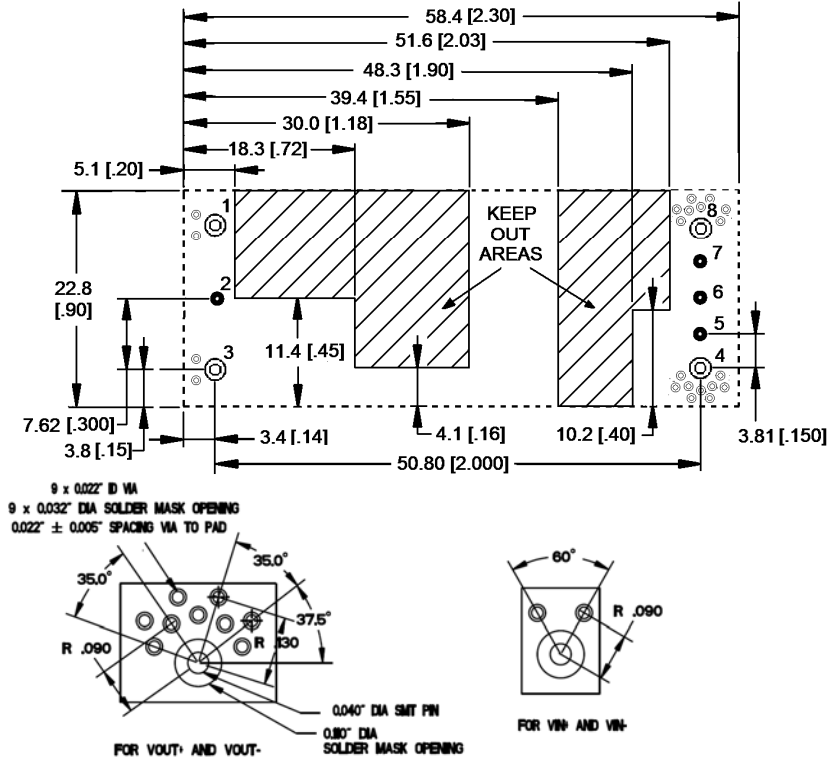

SMT Recommended Pad Layout (Component Side View)

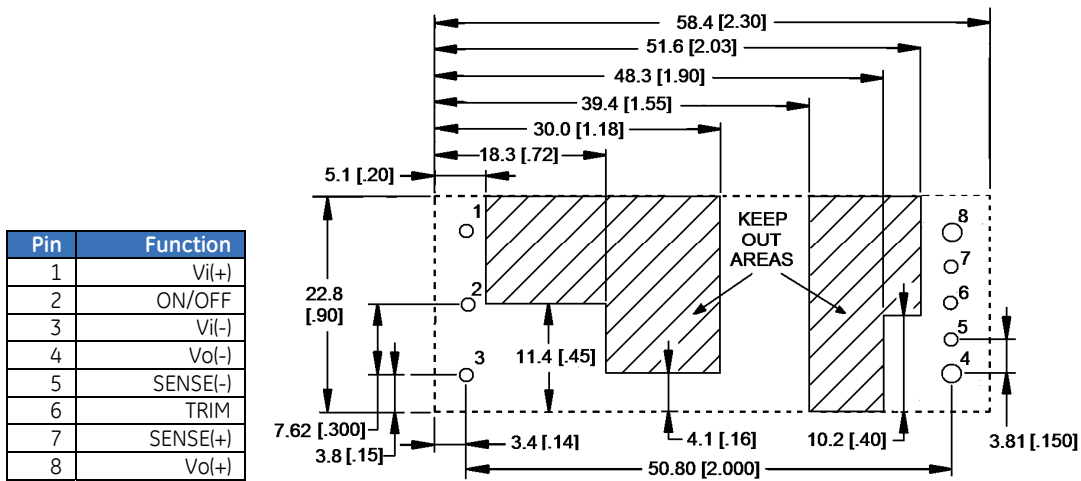

NOTES: FOR 0.030" X 0.025" RECTANGULAR PIN, USE 0.050" PLATED THROUGH HOLE DIAMETER

FOR 0.62 DIA" PIN, USE 0.076" PLATED THROUGH HOLE DIAMETER

TH Recommended Pad Layout (Component Side View)

EHW007A0B Series Eighth-Brick Power Modules

36–75Vdc Input; 12.0Vdc Output; 7A Output Current

Ordering Information

Please contact your GE Sales Representative for pricing, availability and optional features.

Table 1. Device Codes

Product Codes	Input Voltage	Output Voltage	Output Current	On/Off Logic	Connector Type	Comcodes
EHW007A0B41Z	48V (36-75Vdc)	12.0V	7A	Negative	Through hole	CC109145100
EHW007A0B641Z	48V (36-75Vdc)	12.0V	7A	Negative	Through hole	CC109154316
EHW007A0B41-HZ	48V (36-75Vdc)	12.0V	7A	Negative	Through hole	CC109143194
EHW007A0B41-SZ	48V (36-75Vdc)	12.0V	7A	Negative	Surface mount	CC109147402

Table 2. Device Coding Scheme and Options

	Characteristic	Character and Position	Definition
Ratings	Form Factor	E	E = Eighth Brick
	Family Designator	H	
	Input Voltage	W	W = Wide Range, 36V-75V
	Output Current	007A0	007A0 = 007.0 Amps Maximum Output Current
	Output Voltage	B	B = 12.0V nominal
Options	Pin Length	6 8	Omit = Default Pin Length shown in Mechanical Outline Figures 6 = Pin Length: 3.68 mm ± 0.25mm , (0.145 in. ± 0.010 in.) 8 = Pin Length: 2.79 mm ± 0.25mm , (0.110 in. ± 0.010 in.)
	Action following Protective Shutdown	4	Omit = Latching Mode 4 = Auto-restart following shutdown (Overcurrent/Overvoltage)
	On/Off Logic	1	Omit = Positive Logic 1 = Negative Logic
	Mechanical Features	H S	Omit = Standard open Frame Module H = Heat plate, for use with heat sinks (not available with –S) option) S = Surface mount connections
	Customer Specific	XY	XY = Customer Specific Modified Code, Omit for Standard Code
	RoHS	Z	Omit = RoHS 5/6, Lead Based Solder Used Z = RoHS 6/6 Compliant, Lead free

Contact Us

For more information, call us at

USA/Canada:

+1 877 546 3243, or +1 972 244 9288

Asia-Pacific:

+86.021.54279977*808

Europe, Middle-East and Africa:

+49.89.878067-280



www.gecriticalpower.com

GE Critical Power reserves the right to make changes to the product(s) or information contained herein without notice, and no liability is assumed as a result of their use or application. No rights under any patent accompany the sale of any such product(s) or information.