

## EVA-SS

~15° smooth spot beam. Assembly with holder and installation tape.

### SPECIFICATION:

Dimensions	Ø 37.7 mm
Height	17.2 mm
Fastening	tape, pin
ROHS compliant	yes ⓘ

### MATERIALS:

Component	Type	Material	Colour	Finish
EVA-SS	Single lens	PMMA	clear	
EVA-HLD-PIN	Holder	PC	black	
SPUTNIK-TAPE3	Tape	Acrylic foam	black	

### ORDERING INFORMATION:

Component	Type	Qty in box	MOQ	MPQ	Box weight (kg)
CA16256_EVA-SS	Single lens	675	90	45	10.0
» Box size: 480 x 280 x 300 mm					



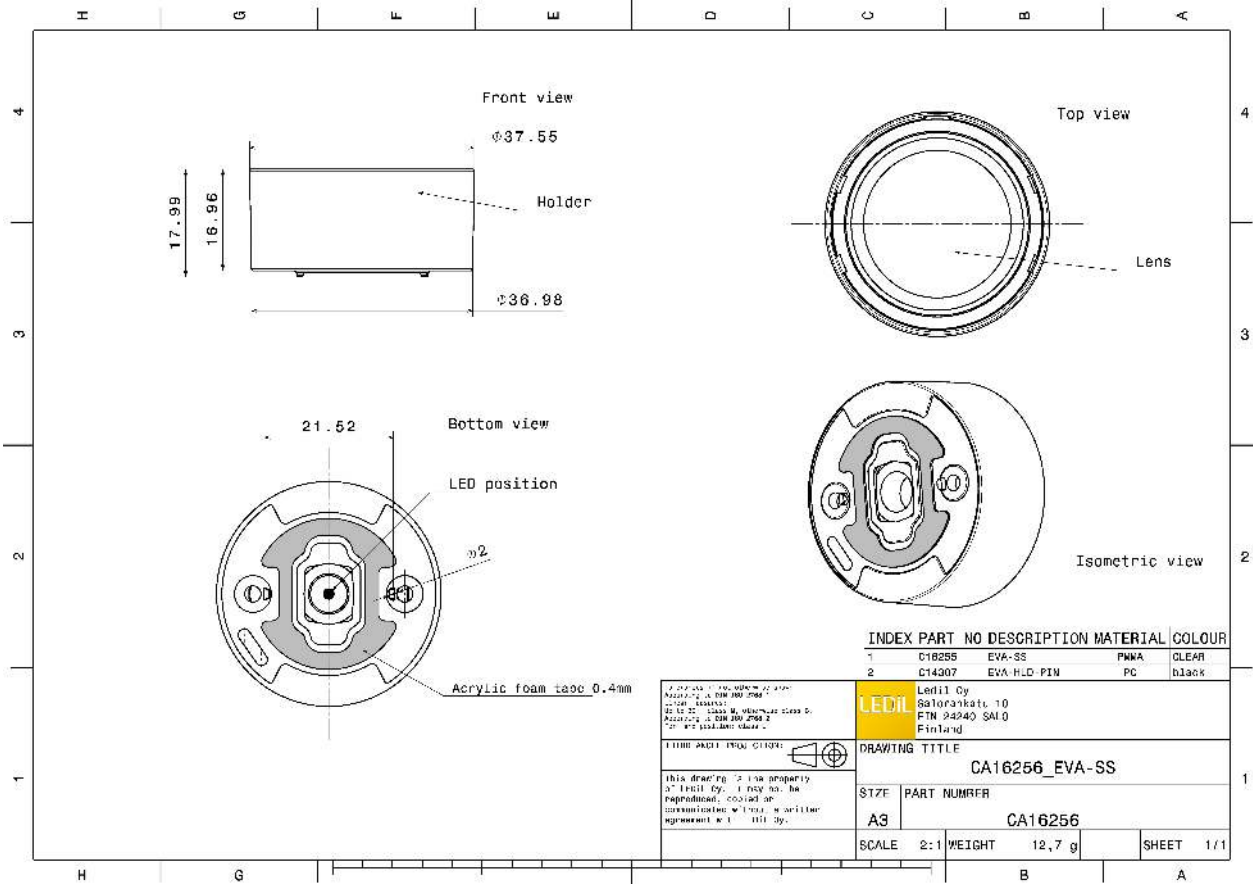

See also our general installation guide: [www.ledil.com/installation\\_guide](http://www.ledil.com/installation_guide)

#### OPTICAL RESULTS (MEASURED):

##### CREE → LED

LED XHP35 HD  
 FWHM / FWTM 14.0° / 25.0°  
 Efficiency 92 %  
 Peak intensity 18 cd/lm  
 LEDs/each optic 1  
 Light colour White  
 Required components:

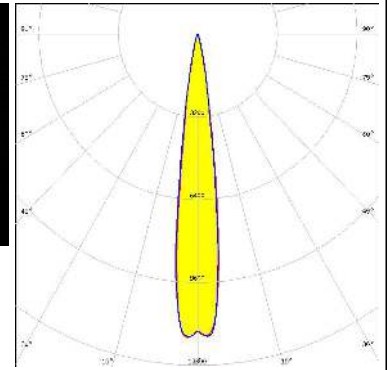

##### CREE → LED

LED XHP35 HI  
 FWHM / FWTM 10.0° / 19.0°  
 Efficiency 93 %  
 Peak intensity 22 cd/lm  
 LEDs/each optic 1  
 Light colour White  
 Required components:

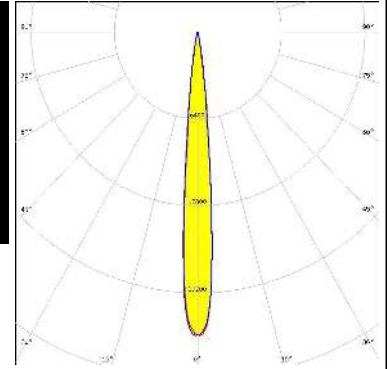

##### CREE → LED

LED XP-E  
 FWHM / FWTM 6.0° / 13.0°  
 Efficiency 93 %  
 Peak intensity 53.7 cd/lm  
 LEDs/each optic 1  
 Light colour White  
 Required components:

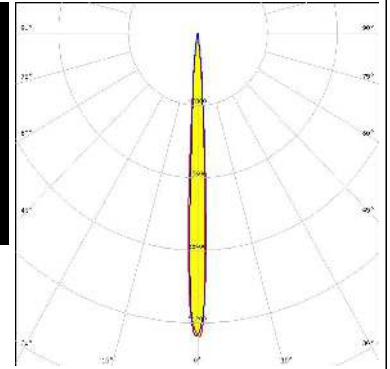
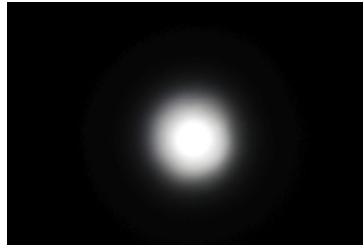

##### CREE → LED

LED XP-G2  
 FWHM / FWTM 8.0° / 17.0°  
 Efficiency 93 %  
 Peak intensity 30 cd/lm  
 LEDs/each optic 1  
 Light colour White  
 Required components:

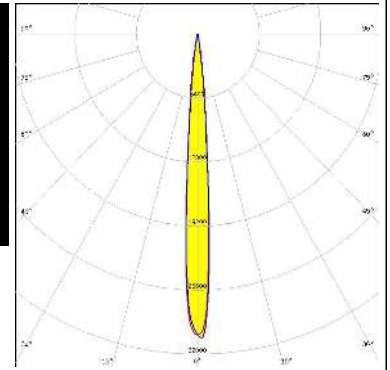

#### OPTICAL RESULTS (MEASURED):

##### CREE LED

LED XP-L HI  
 FWHM / FWTM 8.0° / 15.0°  
 Efficiency 93 %  
 Peak intensity 34.2 cd/lm  
 LEDs/each optic 1  
 Light colour White  
 Required components:

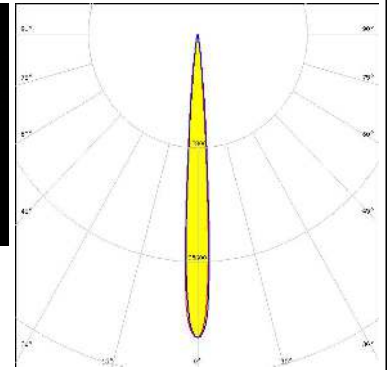

##### CREE LED

LED XT-E  
 FWHM / FWTM 8.0° / 17.0°  
 Efficiency 91 %  
 Peak intensity 29 cd/lm  
 LEDs/each optic 1  
 Light colour White  
 Required components:

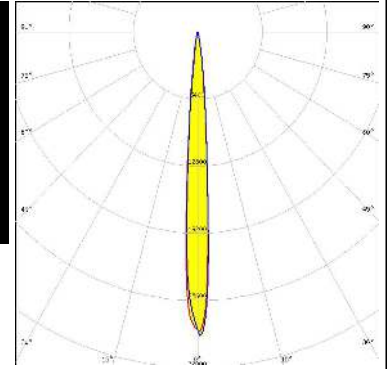

##### LUMILEDS

LED LUXEON CZ  
 FWHM / FWTM 4.0° / 9.0°  
 Efficiency 94 %  
 Peak intensity 99.8 cd/lm  
 LEDs/each optic 1  
 Light colour White  
 Required components:

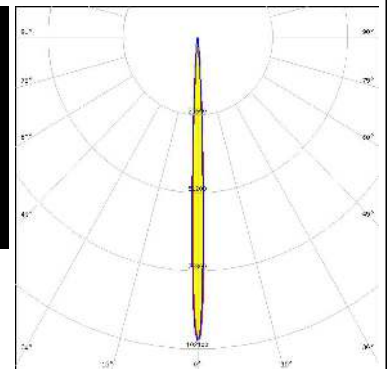
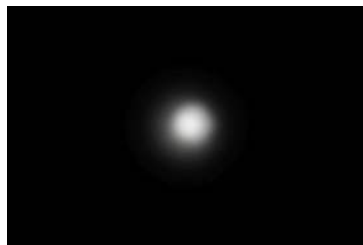

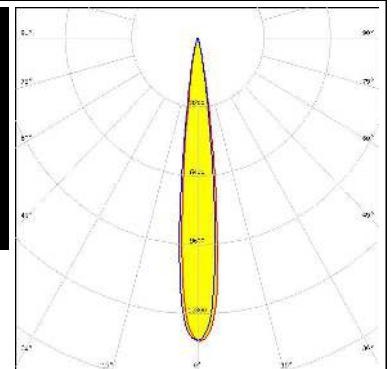

##### LUMILEDS

LED LUXEON V  
 FWHM / FWTM 13.0° / 23.0°  
 Efficiency 91 %  
 Peak intensity 14 cd/lm  
 LEDs/each optic 1  
 Light colour White  
 Required components:

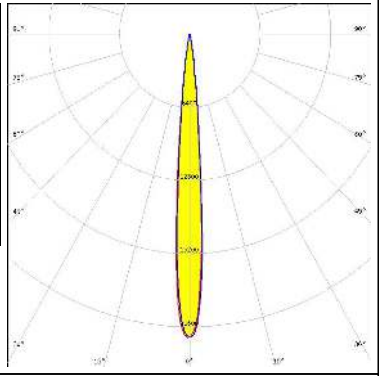
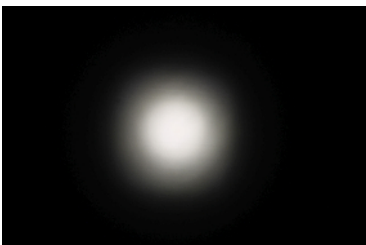
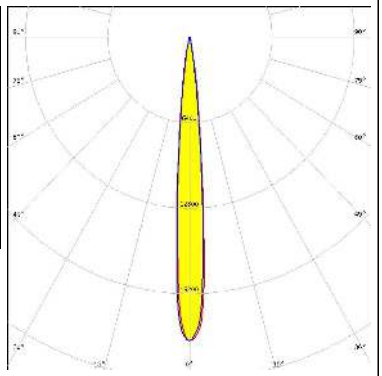

#### OPTICAL RESULTS (MEASURED):

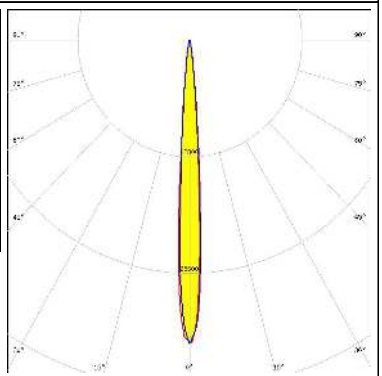
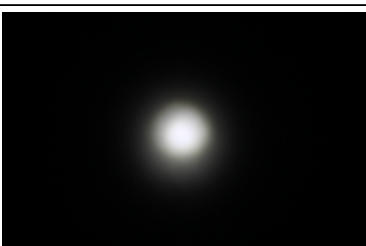
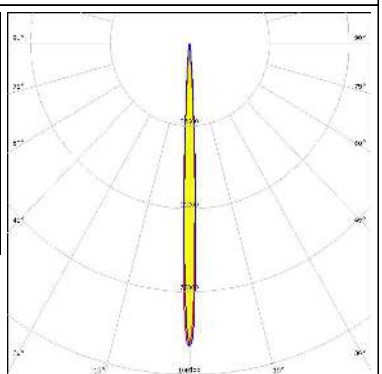
<p><b>LUMILEDS</b></p> <p>LED LUXEON V2</p> <p>FWHM / FWTM 9.0° / 17.0°</p> <p>Efficiency 92 %</p> <p>Peak intensity 26.6 cd/lm</p> <p>LEDs/each optic 1</p> <p>Light colour White</p> <p>Required components:</p>		
<p><b>NICHIA</b></p> <p>LED NVSW219F</p> <p>FWHM / FWTM 10.0° / 19.0°</p> <p>Efficiency 92 %</p> <p>Peak intensity 22.7 cd/lm</p> <p>LEDs/each optic 1</p> <p>Light colour White</p> <p>Required components:</p>		
<p><b>OSRAM</b> Opto Semiconductors</p> <p>LED OSCONIQ P 3737 (2W version)</p> <p>FWHM / FWTM 8.0° / 15.0°</p> <p>Efficiency 94 %</p> <p>Peak intensity 33.3 cd/lm</p> <p>LEDs/each optic 1</p> <p>Light colour White</p> <p>Required components:</p>		
<p><b>OSRAM</b> Opto Semiconductors</p> <p>LED OSLON Black Flat (LUW HWQP)</p> <p>FWHM / FWTM 4.0° / 9.0°</p> <p>Efficiency 94 %</p> <p>Peak intensity 94 cd/lm</p> <p>LEDs/each optic 1</p> <p>Light colour White</p> <p>Required components:</p>		

#### OPTICAL RESULTS (MEASURED):

#### OSRAM

Osram Opto Semiconductors

LED OSLON Square CSSRM2/CSSRM3  
 FWHM / FWTM 8.0° / 16.0°  
 Efficiency 92 %  
 Peak intensity 32 cd/lm  
 LEDs/each optic 1  
 Light colour White  
 Required components:

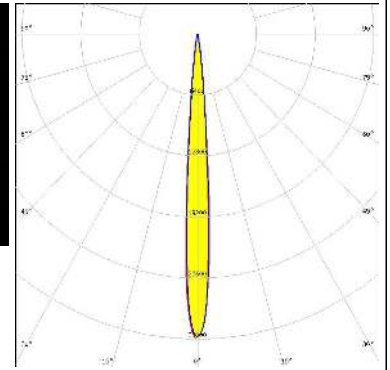

#### OSRAM

Osram Opto Semiconductors

LED OSLON Square EC  
 FWHM / FWTM 8.0° / 15.0°  
 Efficiency 91 %  
 Peak intensity 33.9 cd/lm  
 LEDs/each optic 1  
 Light colour White  
 Required components:

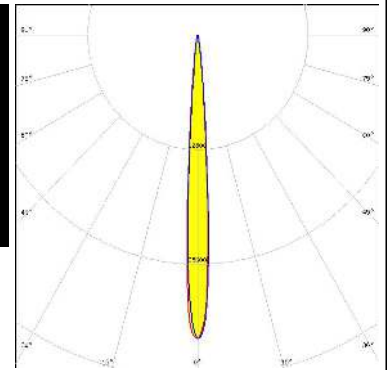

#### OSRAM

Osram Opto Semiconductors

LED OSLON SSL 150  
 FWHM / FWTM 5.0° / 12.0°  
 Efficiency 93 %  
 Peak intensity 63 cd/lm  
 LEDs/each optic 1  
 Light colour White  
 Required components:

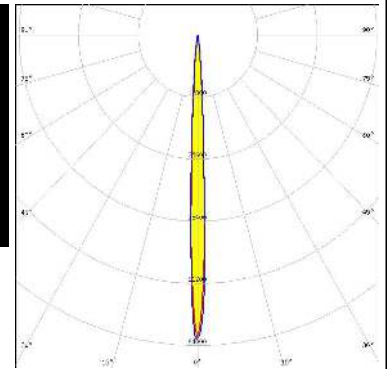

#### SAMSUNG

LED LH181A  
 FWHM / FWTM 7.0° / 16.0°  
 Efficiency 87 %  
 Peak intensity 28.2 cd/lm  
 LEDs/each optic 1  
 Light colour White  
 Required components:

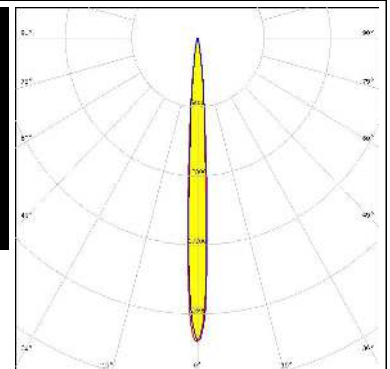

**OPTICAL RESULTS (MEASURED):**

## SAMSUNG

LED LH181B  
FWHM / FWTM 7.8° / 16.0°  
Efficiency 92 %  
Peak intensity 31 cd/lm  
LEDs/each optic 1  
Light colour White  
Required components:

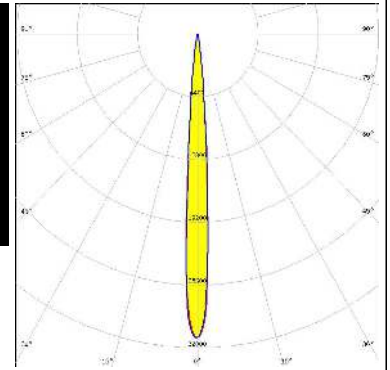
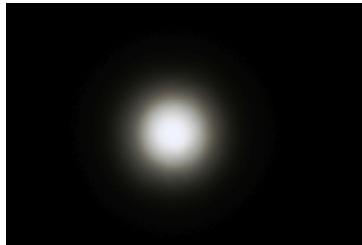

## SAMSUNG

LED LH351B  
FWHM / FWTM 10.0° / 18.0°  
Efficiency 93 %  
Peak intensity 24.3 cd/lm  
LEDs/each optic 1  
Light colour White  
Required components:

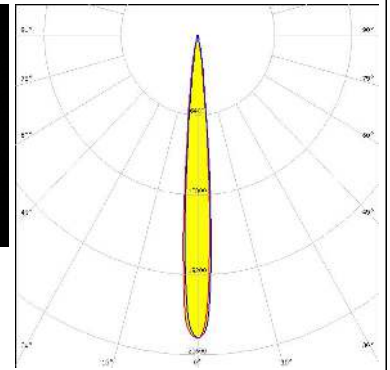
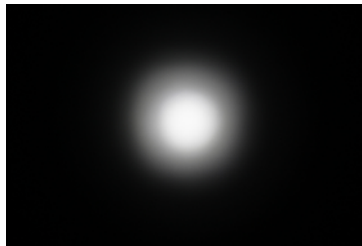

SEOUL SEMICONDUCTOR

LED nPola  
FWHM / FWTM 5.0° / 9.0°  
Efficiency 94 %  
Peak intensity 94 cd/lm  
LEDs/each optic 1  
Light colour White  
Required components:

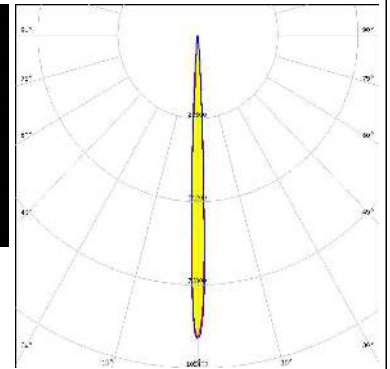

### OPTICAL RESULTS (SIMULATED):

#### CREE LED

LED XE-G  
 FWHM / FWTM 8.0° / 16.0°  
 Efficiency 92 %  
 Peak intensity 30.5 cd/lm  
 LEDs/each optic 1  
 Light colour White  
 Required components:

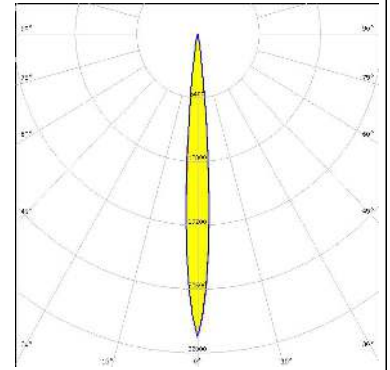

#### CREE LED

LED XHP50.2  
 FWHM / FWTM 20.0° / 34.0°  
 Efficiency 90 %  
 Peak intensity 6.5 cd/lm  
 LEDs/each optic 1  
 Light colour White  
 Required components:

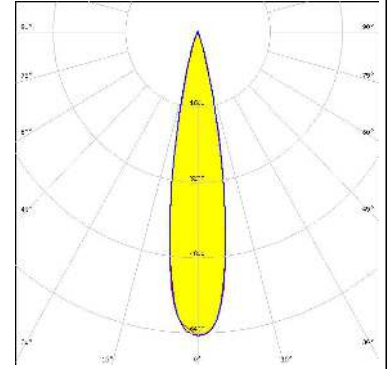

#### CREE LED

LED XP-E2  
 FWHM / FWTM 8.0° / 16.0°  
 Efficiency 93 %  
 Peak intensity 34.7 cd/lm  
 LEDs/each optic 1  
 Light colour White  
 Required components:

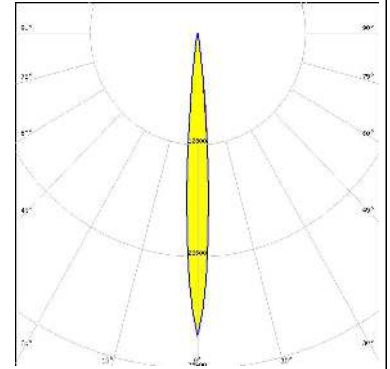

#### CREE LED

LED XP-P  
 FWHM / FWTM 8.0° / 14.0°  
 Efficiency 94 %  
 Peak intensity 37.8 cd/lm  
 LEDs/each optic 1  
 Light colour White  
 Required components:

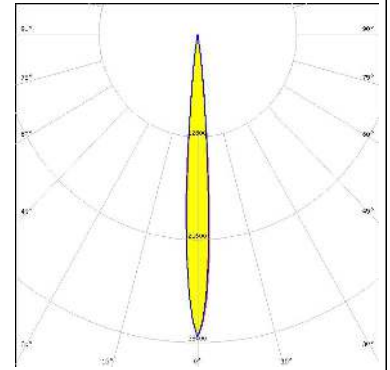



## OPTICAL RESULTS (SIMULATED):



LED	LUXEON MZ
FWHM / FWTM	14.0° / 24.0°
Efficiency	94 %
Peak intensity	13.4 cd/lm
LEDs/each optic	1
Light colour	White
Required components:	

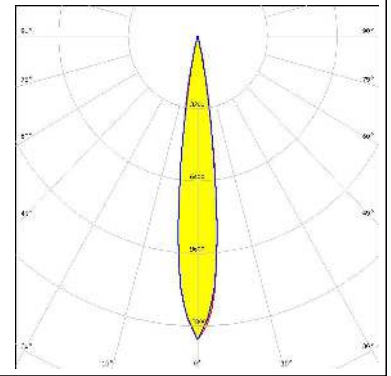

### GENERAL INFORMATION:

NOTE: The typical beam angle will be changed by different color, chip size and chip position tolerance. The typical total beam angle is the full angle measured where the luminous intensity is half of the peak value.

### MATERIALS:

As part of our continuous research and improvement processes, and to ensure the best possible quality and availability of our products, LEDiL reserves the right to change material grades without notice.

### PRODUCT DATA USER AGREEMENT AND DISCLAIMER:

The measured data in the provided downloadable LEDiL Product Datasheets and Mechanical 2D-Drawings is rounded and provided as reference for planning. LEDiL Oy's optical specifications have been verified by conducting performance testing of the products in accordance with the company's quality system. The reported data are averaged results of multiple measurements with typical variation. LEDiL Oy reserves the right to without prior notification make changes and improvements to its products.

LEDiL Oy assumes neither warranty, nor guarantee nor any other liability of any kind for the contents and correctness of the provided data. The provided data has been generated with highest diligence but the provided data may in reality not represent the complete possible variation range of all intrinsic parameters. Therefore, in certain cases a deviation from the provided data could occur.

LEDiL Oy reserves the right to undertake technical changes of its products without further notification which could lead to changes in the provided data. LEDiL Oy assumes no liability of any kind for the possible deviation from any provided data or any other damage resulting from the usage of the provided data.

The user agrees to this disclaimer and user agreement with the download or usage of the provided files.

#### LEDiL Oy

Joensuunkatu 13  
FI-24240 SALO  
Finland

#### LEDiL Inc.

228 West Page Street  
Suite D  
Sycamore IL 60178  
USA

#### Ledil Optics Technology (Shenzhen) Co., Ltd.

# 405 , Block B  
Casic Motor Building  
Shenzhen 518057  
P.R.CHINA

#### Local sales and technical support

[www.ledil.com/  
where\\_to\\_buy](http://www.ledil.com/where_to_buy)

#### Shipping locations

Salo, Finland  
Hong Kong, China

#### Distribution Partners

[www.ledil.com/  
where\\_to\\_buy](http://www.ledil.com/where_to_buy)