

PRELIMINARY SPEC

Part Number: APECVA3010SRCPRV

Super Bright Red

Features

- 3.0mmx1.0mm SMT LED, 2.0mm thickness.
- Low power consumption.
- Wide viewing angle.
- Ideal for back light and indicator.
- Package : 2000pcs / reel.
- Moisture sensitivity level : level 3.
- RoHS compliant.

Description

The Super Bright Red source color devices are made with Gallium Aluminum Arsenide Red Light Emitting Diode.

Package Dimensions

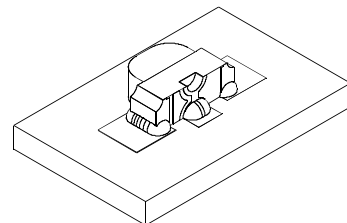
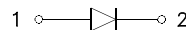
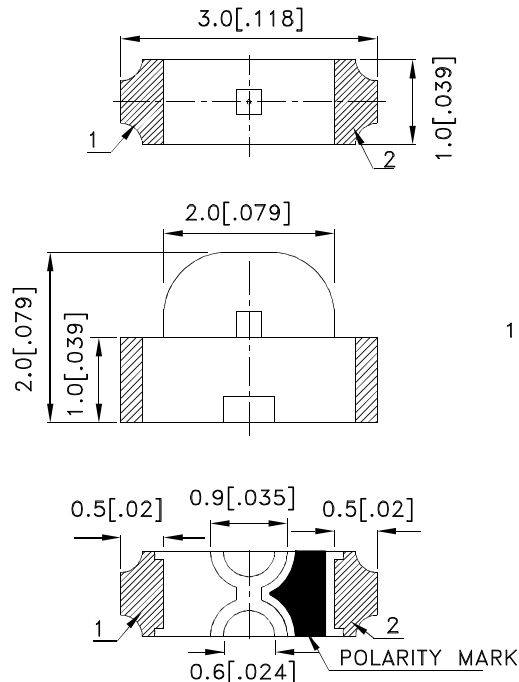

Notes:

1. All dimensions are in millimeters (inches).
2. Tolerance is $\pm 0.15(0.006)$ unless otherwise noted.
3. Specifications are subject to change without notice.
4. The device has a single mounting surface. The device must be mounted according to the specifications.



Selection Guide

Part No.	Dice	Lens Type	Iv (mcd) [2] @ 20mA		Viewing Angle [1]
			Min.	Typ.	2θ1/2
APECVA3010SRCPRV	Super Bright Red (GaAlAs)	WATER CLEAR	50	100	120°

Notes:

1. θ1/2 is the angle from optical centerline where the luminous intensity is 1/2 the optical centerline value.
2. Luminous intensity/ Luminous Flux: +/-15%.

Electrical / Optical Characteristics at TA=25°C

Symbol	Parameter	Device	Typ.	Max.	Units	Test Conditions
λpeak	Peak Wavelength	Super Bright Red	660		nm	IF=20mA
λD [1]	Dominant Wavelength	Super Bright Red	640		nm	IF=20mA
Δλ1/2	Spectral Line Half-width	Super Bright Red	20		nm	IF=20mA
C	Capacitance	Super Bright Red	45		pF	VF=0V;f=1MHz
VF [2]	Forward Voltage	Super Bright Red	1.85	2.5	V	IF=20mA
IR	Reverse Current	Super Bright Red		10	uA	VR=5V

Notes:

1. Wavelength: +/-1nm.
2. Forward Voltage: +/-0.1V.

Absolute Maximum Ratings at TA=25°C

Parameter	Super Bright Red	Units
Power dissipation	75	mW
DC Forward Current	30	mA
Peak Forward Current [1]	155	mA
Reverse Voltage	5	V
Operating Temperature	-40°C To +85°C	
Storage Temperature	-40°C To +85°C	

Note:

1. 1/10 Duty Cycle, 0.1ms Pulse Width.

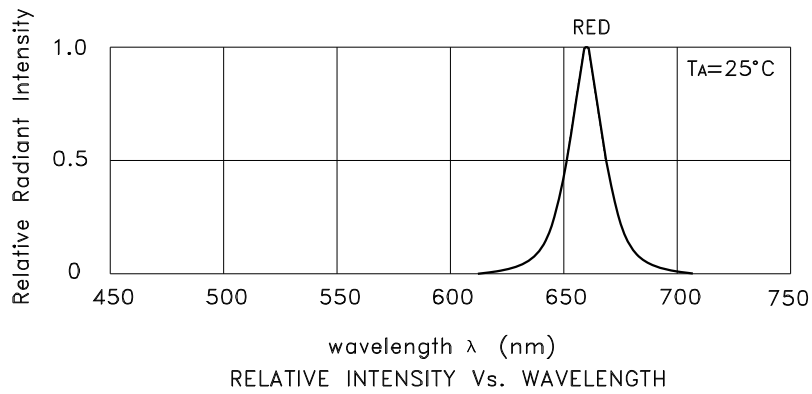

Super Bright Red

APECVA3010SRCPRV

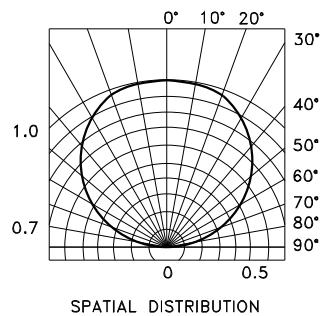
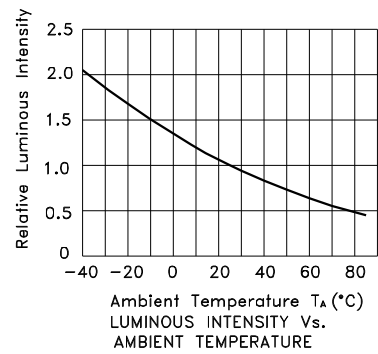
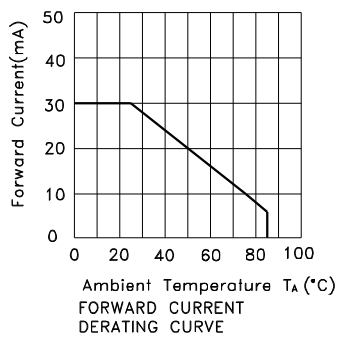
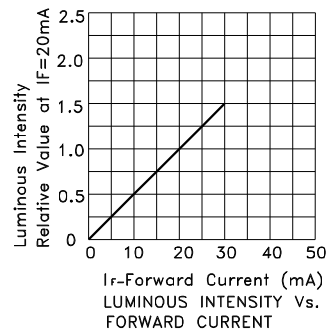
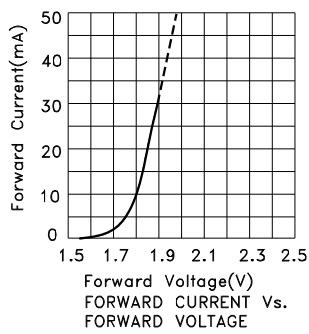

APECVA3010SRCPRV

Reflow soldering is recommended and the soldering profile is shown below.
Other soldering methods are not recommended as they might cause damage to the product.

Reflow Soldering Profile For Lead-free SMT Process.

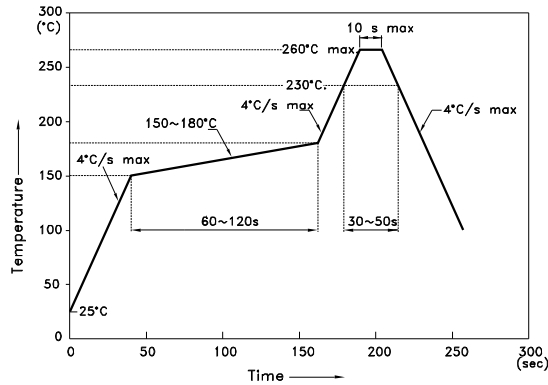

NOTES:

1. We recommend the reflow temperature 245°C(+/-5°C). The maximum soldering temperature should be limited to 260°C.
2. Don't cause stress to the epoxy resin while it is exposed to high temperature.
3. Number of reflow process shall be 2 times or less.

Recommended Soldering Pattern (Units : mm; Tolerance: ± 0.1)

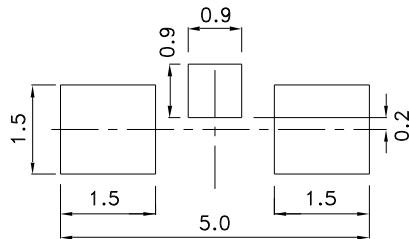

Tape Dimensions (Units : mm)

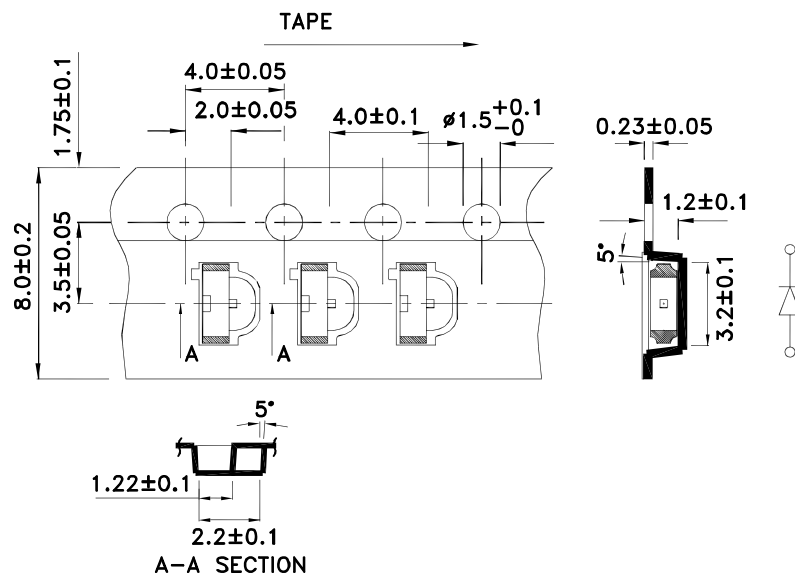

Kingbright

PACKING & LABEL SPECIFICATIONS

APECVA3010SRCPRV

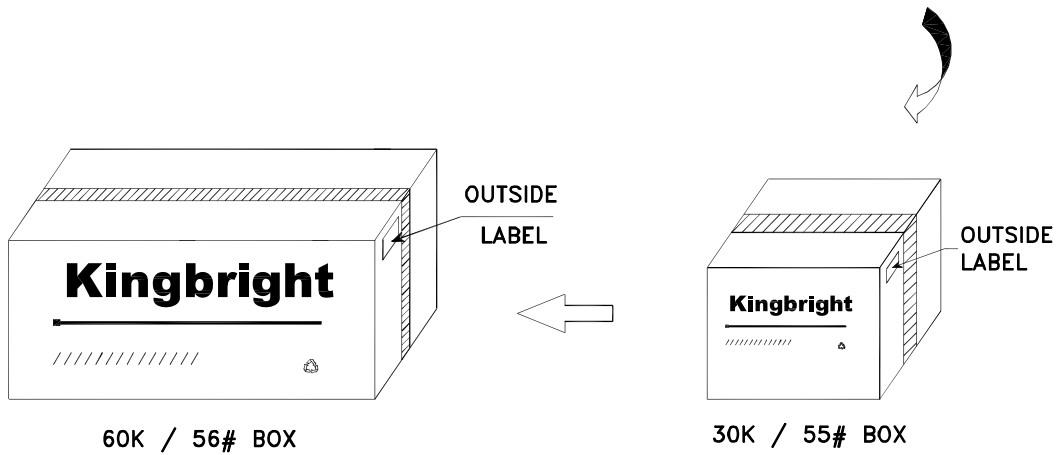
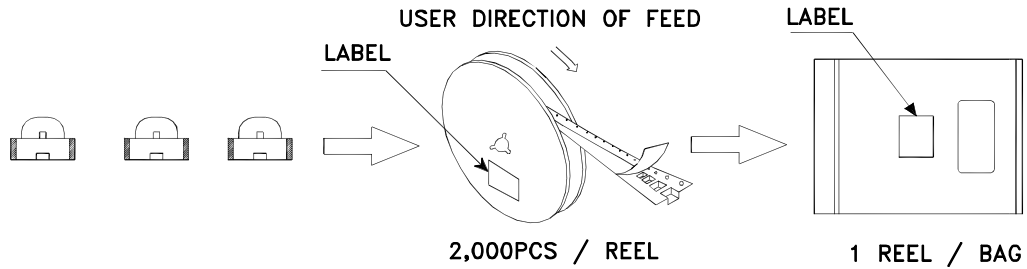

<h2>Kingbright</h2>	
P/NO: APECVA3010xxx	
QTY: 2,000 pcs	Q.C.
S/N: XXXX	<div style="border: 1px solid black; border-radius: 50%; padding: 5px; display: inline-block;"> Q C XX XX XXXX PASSED </div>
CODE: XXX	
LOT NO:	
 <small>XXXXXXXXXXXXXXXXXXXXXXXXXXXX</small>	
RoHS Compliant	