

# GaN Amplifier 50 V, 25 W 30 - 2700 MHz



**MACOM PURE CARBIDE™**

**MAPC-A1000**

Rev. V2

## Features

- MACOM PURE CARBIDE™ Amplifier Series
- Suitable for Linear & Saturated Applications
- CW & Pulsed Operation: 25 W Output Power
- 50 Ω Input Matched
- 260°C Reflow Compatible
- 28 V & 50 V
- 100% RF Tested
- RoHS\* Compliant

## Description

The MAPC-A1000 is a GaN on Silicon Carbide HEMT D-mode amplifier suitable for 30 - 3000 MHz frequency operation. The device supports both CW and pulsed operation with minimum output power levels of 25 W (44 dBm) in a 6.5 x 7.0 mm plastic package.

The MAPC-A1000 has a wide range of applications, including military radio communications, RADAR, avionics, digital cellular infrastructure, RF energy, and test instrumentation.

## Typical Performance:

- Measured under load-pull at 2.5 dB Compression, 100 μs pulse width, 10% duty cycle.
- $V_{DS} = 50\text{ V}$ ,  $I_{DQ} = 40\text{ mA}$ ,  $T_C = 25^\circ\text{C}$

Frequency (GHz)	Output Power <sup>1</sup> (dBm)	Gain <sup>2</sup> (dB)	$\eta_D^2$ (%)
0.9	45.8	13.1	77.2
1.4	45.8	12.6	76.4
2.0	45.9	12.5	74.3
2.7	45.9	11.6	72.0
3.0	45.9	10.8	69.6

- $V_{DS} = 28\text{ V}$ ,  $I_{DQ} = 40\text{ mA}$ ,  $T_C = 25^\circ\text{C}$

Frequency (GHz)	Output Power <sup>1</sup> (dBm)	Gain <sup>2</sup> (dB)	$\eta_D^2$ (%)
0.9	43.1	11.0	74.0
1.4	43.0	10.8	73.0
2.0	43.2	10.7	71.5
2.7	43.3	9.6	70.7
3.0	43.2	8.8	68.2

1. Load impedance tuned for maximum output power.
2. Load impedance tuned for maximum drain efficiency.



6.5 x 7.0 mm DFN

## Functional Schematic

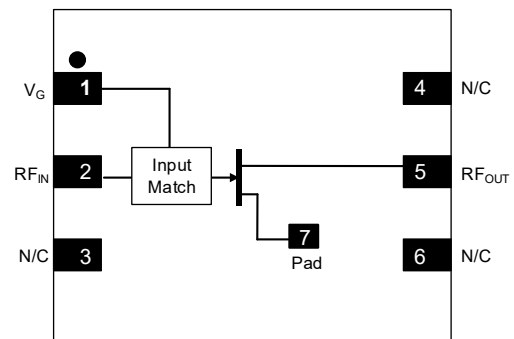

## Pin Configuration

Pin #	Pin Name	Function
1	$V_G$	Gate
2	$RF_{IN}$	RF Input
3, 4, 6	N/C	No Connection
5	$RF_{OUT} / V_D$	RF Output / Drain
7	Pad <sup>3</sup>	Ground / Source

3. The pad on the package bottom must be connected to RF, DC and thermal ground.

## Ordering Information

Part Number	Package
MAPC-A1000-AD000	Bulk Quantity
MAPC-A1000-ADTR1	Tape and Reel
MAPC-A1000-ADSB1	Sample Board

<sup>1</sup> \* Restrictions on Hazardous Substances, compliant to current RoHS EU directive.

**RF Electrical Characteristics:  $T_C = 25^\circ\text{C}$ ,  $V_{DS} = 50\text{ V}$ ,  $I_{DQ} = 40\text{ mA}$**

**Note: Performance in MACOM Evaluation Test Fixture, 50  $\Omega$  system**

Parameter	Test Conditions	Symbol	Min.	Typ.	Max.	Units
Small Signal Gain	Pulsed <sup>4</sup> , 2.7 GHz	$G_{SS}$	-	12.8	-	dB
Power Gain	Pulsed <sup>4</sup> , 2.7 GHz, 2.5 dB Gain Compression	$G_{SAT}$	-	10.3	-	dB
Saturated Drain Efficiency	Pulsed <sup>4</sup> , 2.7 GHz, 2.5 dB Gain Compression	$\eta_{SAT}$	-	60	-	%
Saturated Output Power	Pulsed <sup>4</sup> , 2.7 GHz, 2.5 dB Gain Compression	$P_{SAT}$	-	44.8	-	dBm
Gain Variation (-40°C to +85°C)	Pulsed <sup>4</sup> , 2.7 GHz	$\Delta G$	-	0.017	-	dB/°C
Power Variation (-40°C to +85°C)	Pulsed <sup>4</sup> , 2.7 GHz	$\Delta P_{2.5dB}$	-	0.003	-	dBm/°C
Power Gain	Pulsed <sup>4</sup> , 2.7 GHz, $P_{IN} = 32.7\text{ dBm}$	$G_P$	-	11.3	-	dB
Drain Efficiency	Pulsed <sup>4</sup> , 2.7 GHz, $P_{IN} = 32.7\text{ dBm}$	$\eta$	-	56.4	-	%
Input Return Loss	Pulsed <sup>4</sup> , 2.7 GHz, $P_{IN} = 32.7\text{ dBm}$	IRL	-	-8.7	-	dB
Ruggedness: Output Mismatch	All phase angles	$\Psi$	VSWR = 10:1, No Damage			

**RF Electrical Specifications:  $T_A = 25^\circ\text{C}$ ,  $V_{DS} = 50\text{ V}$ ,  $I_{DQ} = 40\text{ mA}$**

**Note: Performance in MACOM Production Test Fixture, 50  $\Omega$  system**

Parameter	Test Conditions	Symbol	Min.	Typ.	Max.	Units
Power Gain	Pulsed <sup>4</sup> , 2.7 GHz, 2.5 dB Gain Compression	$G_{SAT}$	9.0	10.0	-	dB
Saturated Drain Efficiency	Pulsed <sup>4</sup> , 2.7 GHz, 2.5 dB Gain Compression	$\eta_{SAT}$	48	52.7	-	%
Saturated Output Power	Pulsed <sup>4</sup> , 2.7 GHz, 2.5 dB Gain Compression	$P_{SAT}$	43	44.4	-	dBm
Power Gain	Pulsed <sup>4</sup> , 2.7 GHz, $P_{IN} = 33.6\text{ dBm}$	$G_P$	10	10.5	-	dB
Drain Efficiency	Pulsed <sup>4</sup> , 2.7 GHz, $P_{IN} = 33.6\text{ dBm}$	$\eta$	48	52.6	-	%
Input Return Loss	Pulsed <sup>4</sup> , 2.7 GHz, $P_{IN} = 33.6\text{ dBm}$	IRL	-7.5	-9	-	dB

4. Pulse details: 100  $\mu\text{s}$  pulse width, 10% Duty Cycle.

**DC Electrical Characteristics:  $T_A = 25^\circ\text{C}$**

Parameter	Test Conditions	Symbol	Min.	Typ.	Max.	Units
Drain-Source Leakage Current	$V_{GS} = -8\text{ V}$ , $V_{DS} = 130\text{ V}$	$I_{DLK}$	-	-	3.3	mA
Gate-Source Leakage Current	$V_{GS} = -8\text{ V}$ , $V_{DS} = 0\text{ V}$	$I_{GLK}$	-	-	3.3	mA
Gate Threshold Voltage	$V_{DS} = 50\text{ V}$ , $I_D = 3.3\text{ mA}$	$V_T$	-3.3	-2.9	-	V
Gate Quiescent Voltage	$V_{DS} = 50\text{ V}$ , $I_D = 40\text{ mA}$	$V_{GSQ}$	-	-2.75	-	V
On Resistance	$V_{GS} = 2\text{ V}$ , $I_D = 24.8\text{ mA}$	$R_{ON}$	-	1.45	-	$\Omega$
Maximum Drain Current	$V_{DS} = 7\text{ V}$ , pulse width 300 $\mu\text{s}$	$I_{D,MAX}$	-	3.94	-	A

**Absolute Maximum Ratings**<sup>5,6,7,8,9</sup>

Parameter	Absolute Maximum
Drain Source Voltage, $V_{DS}$	130 V
Gate Source Voltage, $V_{GS}$	-10 to 3 V
Gate Current, $I_G$	6.62 mA
Storage Temperature Range	-65°C to +150°C
Case Operating Temperature Range	-40°C to +85°C
Channel Operating Temperature Range, $T_{CH}$	-40°C to +225°C
Absolute Maximum Channel Temperature	+250°C

5. Exceeding any one or combination of these limits may cause permanent damage to this device.
6. MACOM does not recommend sustained operation above maximum operating conditions.
7. Operating at drain source voltage  $V_{DS} < 55$  V will ensure  $MTTF > 2 \times 10^6$  hours.
8. Operating at nominal conditions with  $T_{CH} \leq 225^\circ\text{C}$  will ensure  $MTTF > 2 \times 10^6$  hours.
9. MTTF may be estimated by the expression  $MTTF \text{ (hours)} = A e^{[B + C/(T+273)]}$  where  $T$  is the channel temperature in degrees Celsius,  $A = 1$ ,  $B = -38,215$ , and  $C = 26,343$ .

**Thermal Characteristics**<sup>10</sup>

Parameter	Test Conditions	Symbol	Typical	Units
Thermal Resistance using Finite Element Analysis	$V_{DS} = 50$ V $T_C = 85^\circ\text{C}, T_{CH} = 225^\circ\text{C}$	$R_{\theta}(\text{FEA})$	6.9	°C/W
Thermal Resistance using Infrared Measurement of Die Surface Temperature	$V_{DS} = 50$ V $T_C = 85^\circ\text{C}, T_{CH} = 225^\circ\text{C}$	$R_{\theta}(\text{IR})$	5.5	°C/W

10. Case temperature measured using thermocouple embedded in heat-sink. Contact local applications support team for more details on this measurement.

**Handling Procedures**

Please observe the following precautions to avoid damage:

**Static Sensitivity**

Gallium Nitride Circuits are sensitive to electrostatic discharge (ESD) and can be damaged by static electricity. Proper ESD control techniques should be used when handling these devices.

Pulsed<sup>4</sup> Load-Pull Performance at 50 V  
Reference Plane at Device Leads

Frequency (GHz)	Z <sub>SOURCE</sub> (Ω)	Maximum Output Power					
		V <sub>DS</sub> = 50 V, I <sub>DQ</sub> = 40 mA, T <sub>C</sub> = 25°C, P2.5dB					
		Z <sub>LOAD</sub> <sup>11</sup> (Ω)	Gain (dB)	P <sub>OUT</sub> (dBm)	P <sub>OUT</sub> (W)	η <sub>D</sub> (%)	AM/PM (°)
0.9	23.1 + j2.7	18.2 - j14.5	11.7	45.8	38.0	65.5	112.0
1.4	27.9 + j6.4	19.9 + j7.1	11.5	45.8	38.0	63.4	96.6
2.0	25.8 - j1.2	14.8 + j6.2	11.5	45.9	38.9	61.5	45.0
2.7	25.2 - j20	14.8 + j0.3	11.0	45.9	38.9	62.6	-10.0
3.0	36.1 - j31.4	12.6 - j2.3	10.2	45.9	38.9	59.3	-29.3

Frequency (GHz)	Z <sub>SOURCE</sub> (Ω)	Maximum Drain Efficiency					
		V <sub>DS</sub> = 50 V, I <sub>DQ</sub> = 40 mA, T <sub>C</sub> = 25°C, P2.5dB					
		Z <sub>LOAD</sub> <sup>12</sup> (Ω)	Gain (dB)	P <sub>OUT</sub> (dBm)	P <sub>OUT</sub> (W)	η <sub>D</sub> (%)	AM/PM (°)
0.9	21.2 + j 2.9	33.1 + j8.3	13.1	42.9	19.5	77.2	100.9
1.4	25.8 + j6.4	22.9 + j27	12.6	43.7	23.4	76.4	84.2
2.0	23.8 - j1.9	9.8 + j15.2	12.5	44.1	25.7	74.3	31.0
2.7	28.7 - j21.5	10.2 + j7.1	11.6	44.7	29.5	72.2	-20.7
3.0	39.8 - j31.6	8.4 + j3.3	10.8	44.8	30.2	69.6	-42.2

Impedance Reference

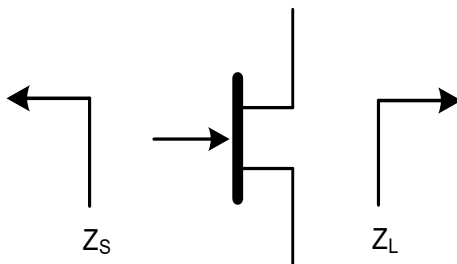

Z<sub>SOURCE</sub> = Measured impedance presented to the input of the device at package reference plane.

Z<sub>LOAD</sub> = Measured impedance presented to the output of the device at package reference plane.

- 11. Load Impedance for optimum output power.
- 12. Load Impedance for optimum efficiency.

**Pulsed<sup>4</sup> Load-Pull Performance @ 2.7 GHz**

**P2.5dB Loadpull Output Power Contours (dBm)**

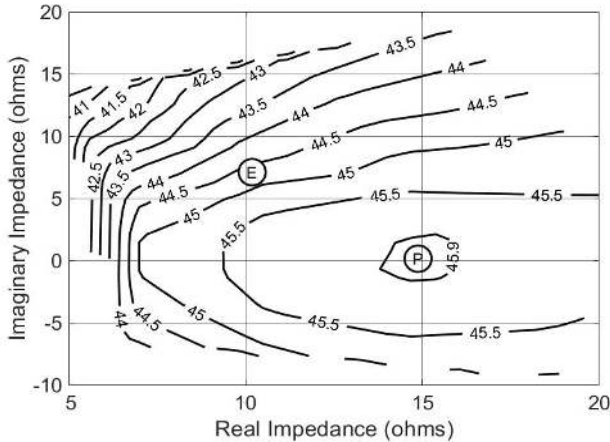

**P2.5dB Loadpull Drain Efficiency Contours (%)**

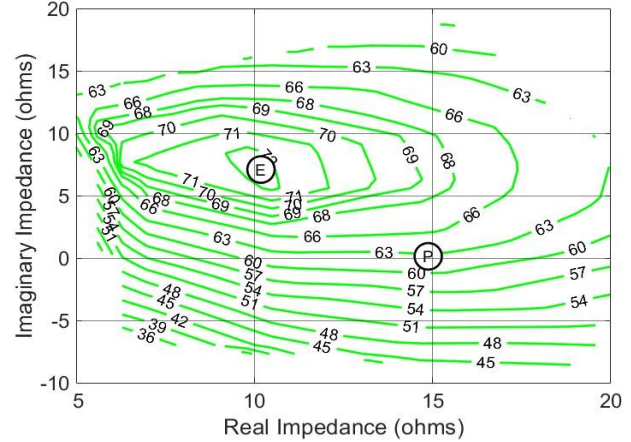

**P2.5dB Loadpull Gain Contours (dB)**

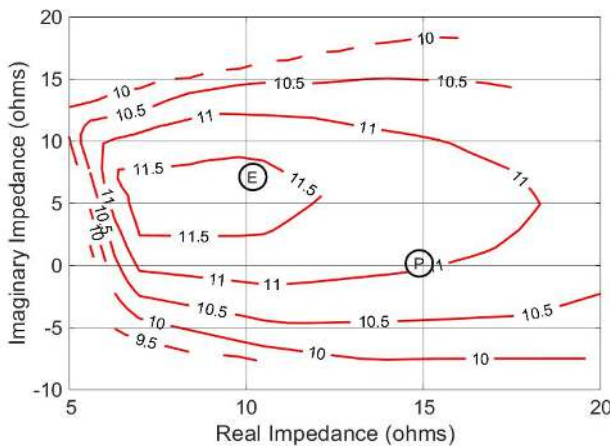

**P2.5dB Loadpull AM/PM Contours (°)**

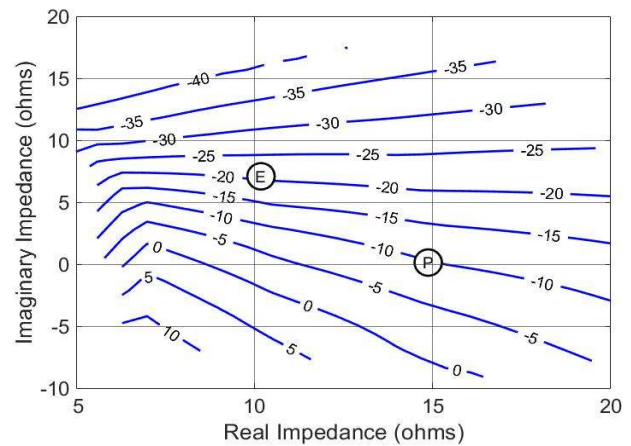

**Gain vs. Output Power**

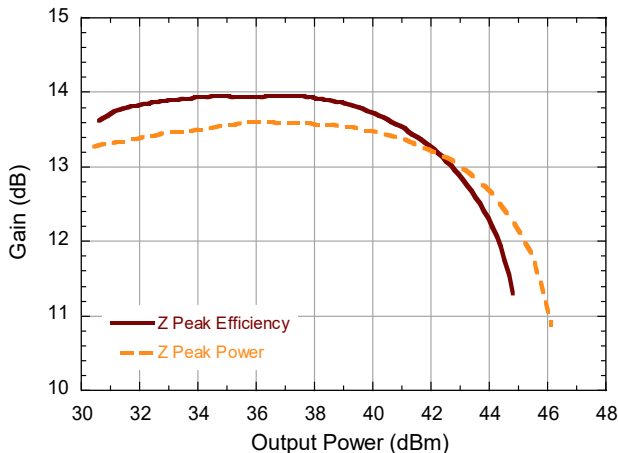

**Drain Efficiency vs. Output Power**

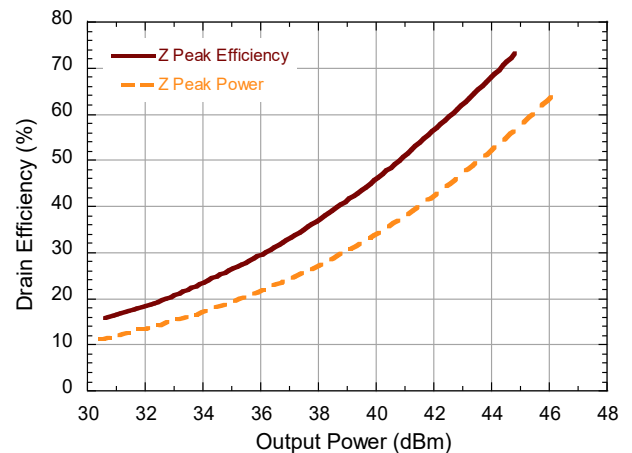

**Pulsed<sup>4</sup> Load-Pull Performance at 28 V  
Reference Plane at Device Leads**

Frequency (GHz)	Z <sub>SOURCE</sub> (Ω)	Maximum Output Power					
		V <sub>DS</sub> = 28 V, I <sub>DQ</sub> = 40 mA, T <sub>C</sub> = 25°C, P2.5dB					
		Z <sub>LOAD</sub> <sup>11</sup> (Ω)	Gain (dB)	P <sub>OUT</sub> (dBm)	P <sub>OUT</sub> (W)	η <sub>D</sub> (%)	AM/PM (°)
0.9	22.3 + j3.4	7.7 + j10.3	9.3	43.1	20.4	60.0	128.0
1.4	27.9 + j8.7	13.6 + j1.9	9.4	43.0	20.0	57.7	93.0
2.0	25.1 - j0.5	13.1 - j1.8	9.4	43.2	20.9	57.6	50.6
2.7	28.5 - j20.8	12.5 - j5.2	8.9	43.3	21.4	61.2	-1.8
3.0	43 - j30.3	12 - j7.5	8.3	43.2	20.9	59.7	-26.7

Frequency (GHz)	Z <sub>SOURCE</sub> (Ω)	Maximum Drain Efficiency					
		V <sub>DS</sub> = 28 V, I <sub>DQ</sub> = 40 mA, T <sub>C</sub> = 25°C, P2.5dB					
		Z <sub>LOAD</sub> <sup>12</sup> (Ω)	Gain (dB)	P <sub>OUT</sub> (dBm)	P <sub>OUT</sub> (W)	η <sub>D</sub> (%)	AM/PM (°)
0.9	18.9 + j3.0	13.5 + j25	11.0	38.4	6.9	74.0	111
1.4	24.7 + j5.6	14.9 + j16.8	10.8	40.8	12.0	73.0	72.1
2.0	24.5 - j4.7	12 + j10.1	10.7	41.6	14.5	71.5	32.2
2.7	32.6 - j22.9	9.9 + j4.5	9.6	41.7	14.8	70.7	-20.5
3.0	47.1 - j30.6	9.6 + j0.2	8.8	41.9	15.5	68.2	-40.5

**Impedance Reference**

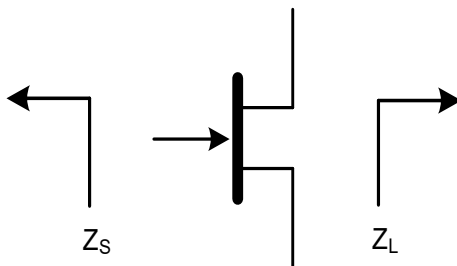

Z<sub>SOURCE</sub> = Measured impedance presented to the input of the device at package reference plane.

Z<sub>LOAD</sub> = Measured impedance presented to the output of the device at package reference plane.

- 11. Load Impedance for optimum output power.
- 12. Load Impedance for optimum efficiency.

Evaluation Test Fixture and Recommended Tuning Solution 0.5 - 2.7 GHz

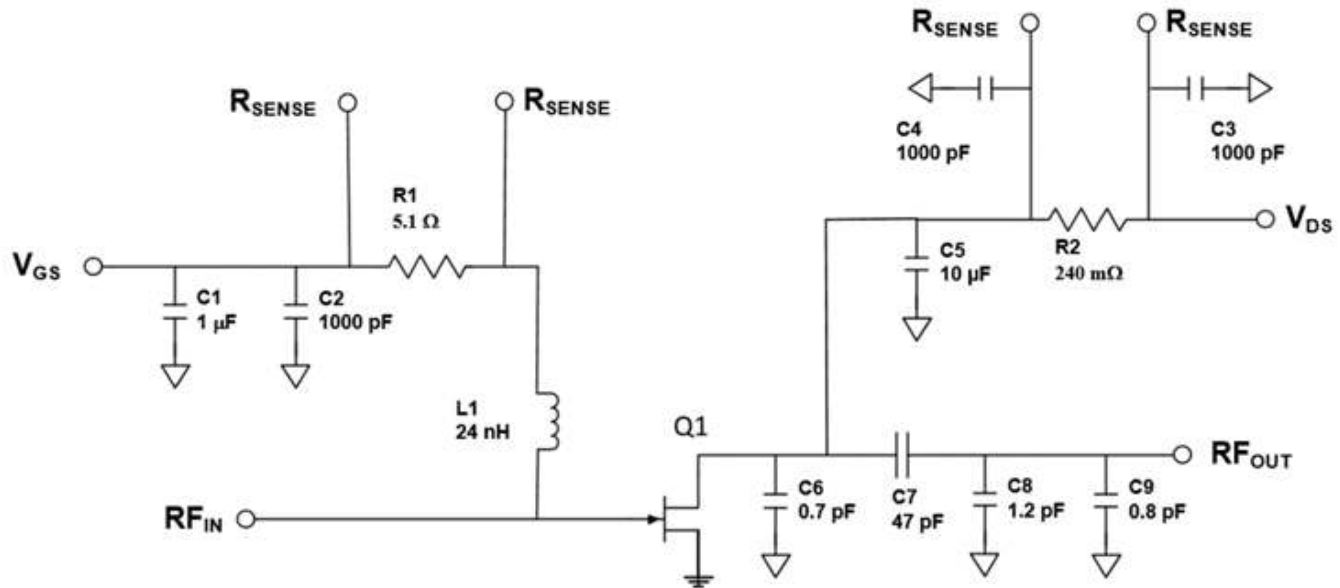

**Description**

Parts measured on evaluation board (20-mil thick RO4350). Matching is provided using a combination of lumped elements and transmission lines as shown in the simplified schematic above. Recommended tuning solution component placement, transmission lines, and details are shown on the next page.

**Bias Sequencing**

**Turning the device ON**

1. Set  $V_{GS}$  to pinch-off ( $V_P$ ).
2. Turn on  $V_{DS}$  to nominal voltage (50 V).
3. Increase  $V_{GS}$  until  $I_{DS}$  current is reached.
4. Apply RF power to desired level.

**Turning the device OFF**

1. Turn the RF power OFF.
2. Decrease  $V_{GS}$  down to  $V_P$  pinch-off.
3. Decrease  $V_{DS}$  down to 0 V.
4. Turn off  $V_{GS}$ .



**Evaluation Test Fixture and Recommended Tuning Solution 0.5 - 2.7 GHz**

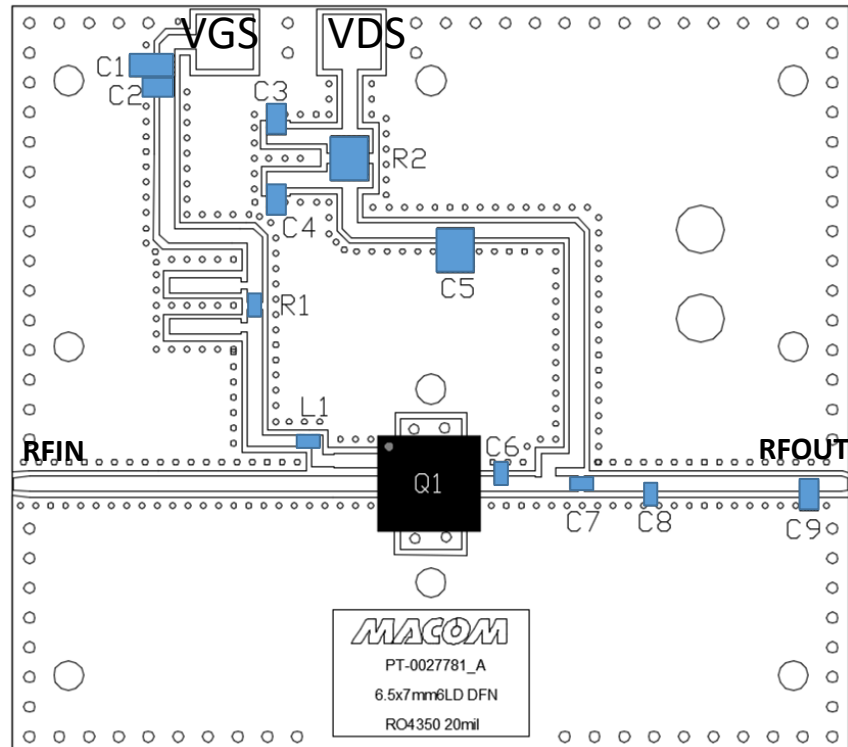

Reference Designator	Value	Tolerance	Manufacturer	Part Number
C1	1 $\mu$ F	+/- 10 %	Murata	GRM31CR72A105KA01L
C2, C3, C4	1000 pF	+/- 5 %	Murata	GRM219R72A102JA01D
C5	10 $\mu$ F	+/- 10 %	Murata	GRM32EC72A106KE05L
C6	0.7 pF	+/- 0.1 pF	PPI	0603N0R7BL250
C7	47 pF	+/- 5 %	PPI	0603N470JL250
C8	1.2 pF	+/- 0.1 pF	PPI	0603N1R2BL250
C9	0.8 pF	+/- 0.1 pF	PPI	0805N0R8BW251X
R1	5.1 $\Omega$	+/- 1 %	Vishay Dale	CRCW06035R10FKEA
R2	240 m $\Omega$	+/- 1%	Vishay Dale	RCWE1210R240FKEA
L1	24 nH	+/- 2 %	CoilCraft	0603HP-24NXGLW
Q1	MACOM GaN Power Amplifier		MAPC-A1000	
PCB	RO4350, 20 mil, 0.5 oz. Cu, Au Finish			



Typical Performance Curves as Measured in the 0.5 - 2.7 GHz Evaluation Test Fixture:  
Pulsed<sup>4</sup> 2.7 GHz,  $V_{DS} = 50\text{ V}$ ,  $I_{DQ} = 40\text{ mA}$ ,  $T_C = 25^\circ\text{C}$  (Unless Otherwise Noted)

Gain vs. Output Power and Frequency

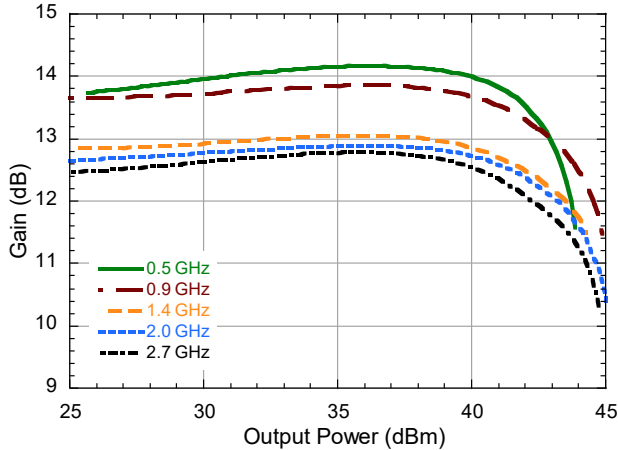

Drain Efficiency vs. Output Power and Frequency

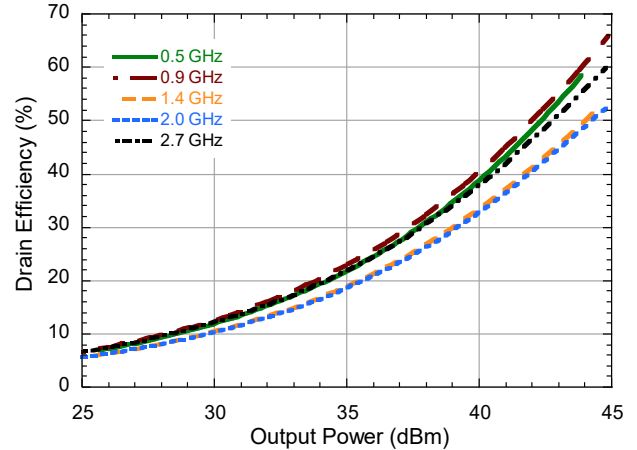

Gain vs. Output Power and  $V_{DS}$

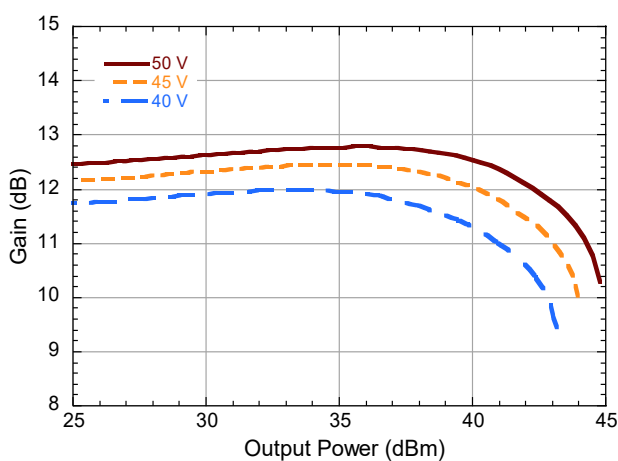

Drain Efficiency vs. Output Power and  $V_{DS}$

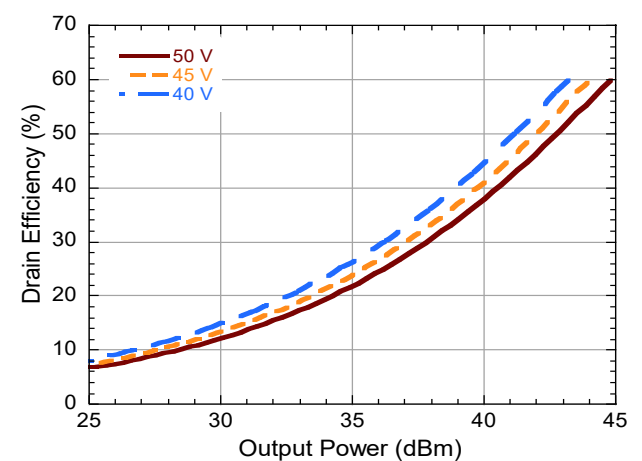

Gain vs. Output Power and  $I_{DQ}$

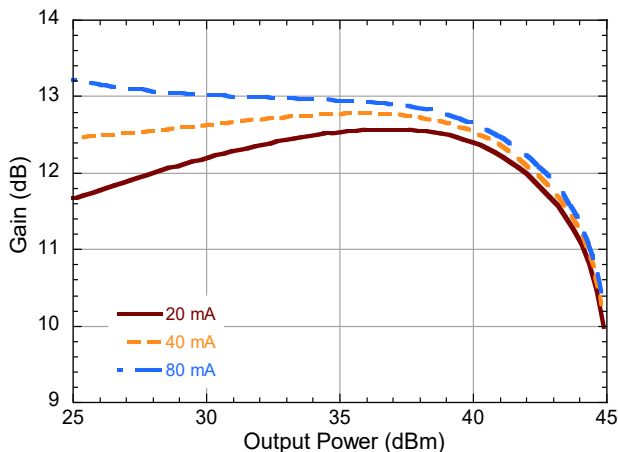

Drain Efficiency vs. Output Power and  $I_{DQ}$

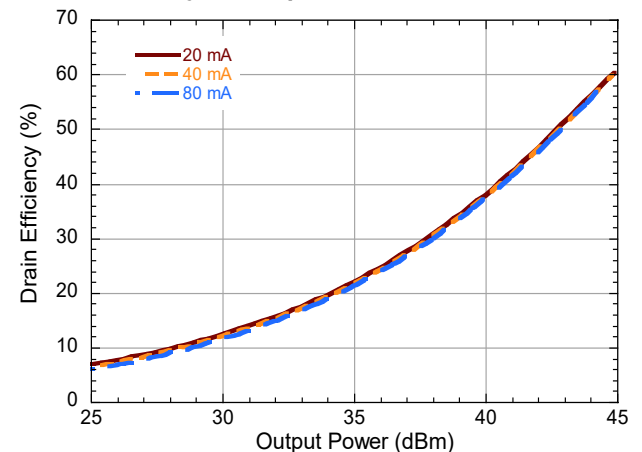

Typical Performance Curves as Measured in the 0.5 - 2.7 GHz Evaluation Test Fixture:  
Pulsed<sup>4</sup> 2.7 GHz,  $V_{DS} = 50$  V,  $I_{DQ} = 40$  mA,  $T_C = 25^\circ\text{C}$  (Unless Otherwise Noted)

Gain vs. Output Power and  $T_C$

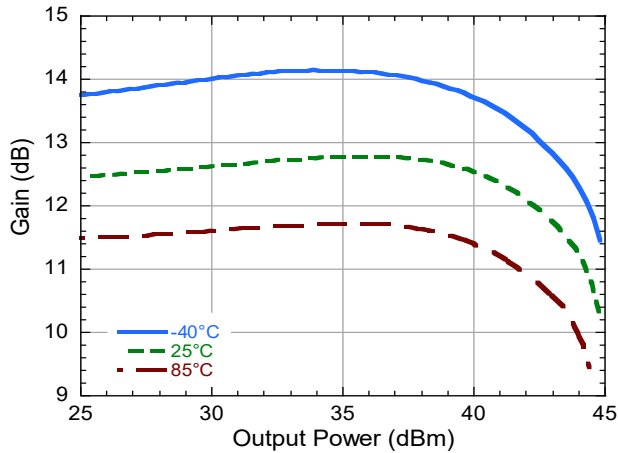

Drain Efficiency vs. Output Power and  $T_C$

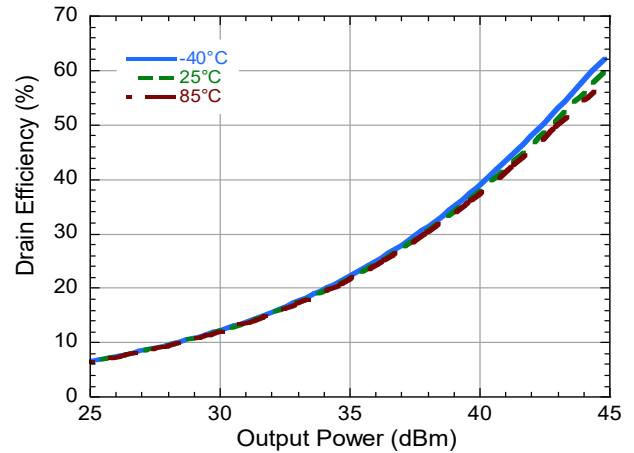

Gain vs. Frequency, 2.5dB Compression

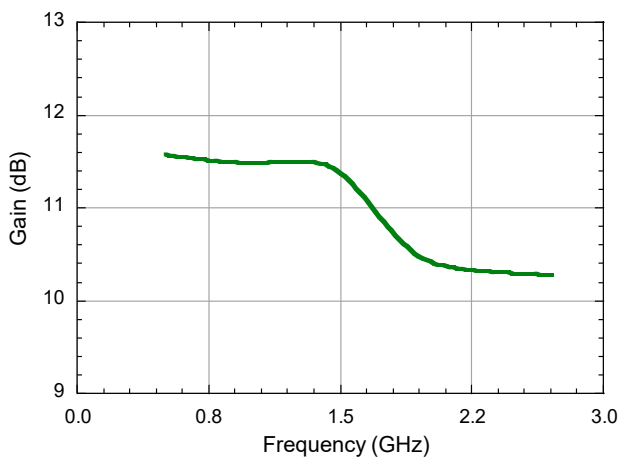

Drain Efficiency vs. Frequency, 2.5dB Compression

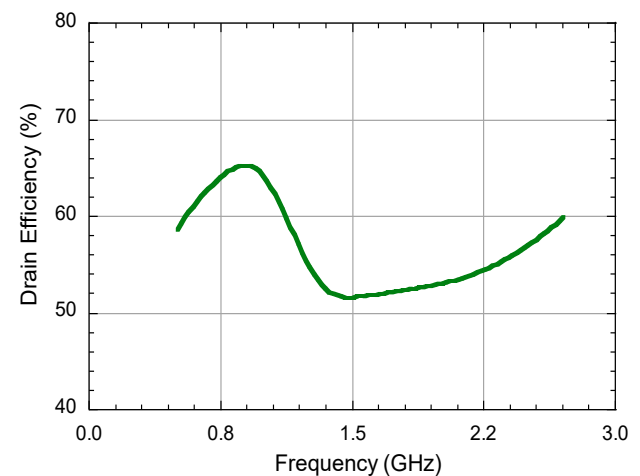

Output Power vs. Frequency, 2.5dB Compression

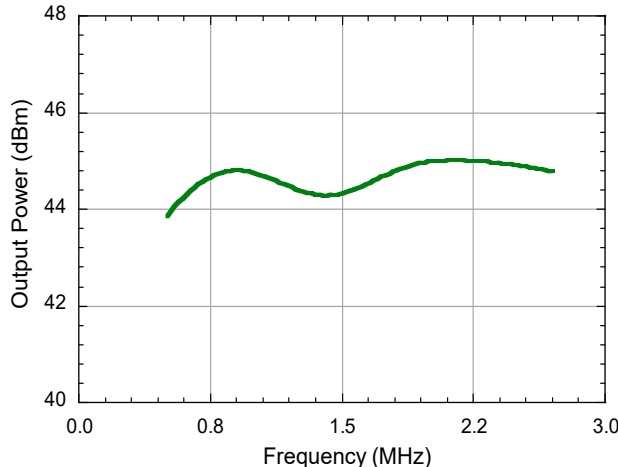

Lead-Free 6.5 x 7.0 mm 6-Lead Package Dimensions†

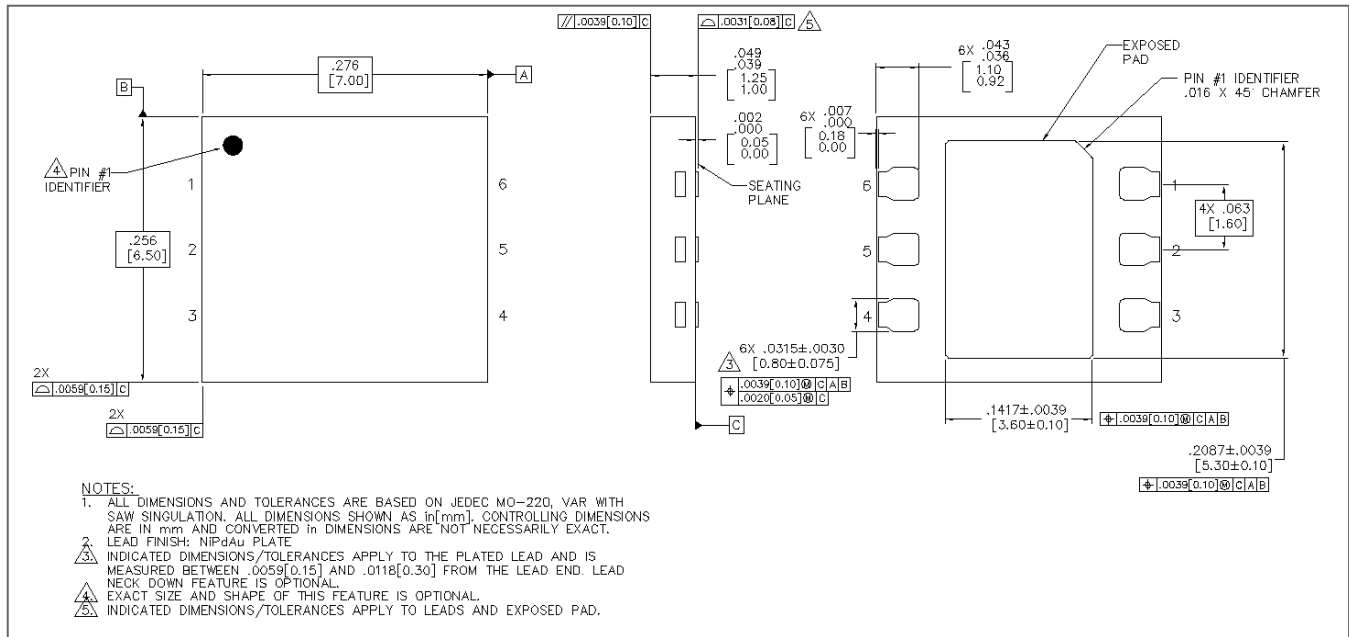

† Reference Application Note S2083 for lead-free solder reflow recommendations.  
Meets JEDEC moisture sensitivity level (MSL) 3 requirements.  
Plating is NiPdAu.

MACOM Technology Solutions Inc. ("MACOM"). All rights reserved.

These materials are provided in connection with MACOM's products as a service to its customers and may be used for informational purposes only. Except as provided in its Terms and Conditions of Sale or any separate agreement, MACOM assumes no liability or responsibility whatsoever, including for (i) errors or omissions in these materials; (ii) failure to update these materials; or (iii) conflicts or incompatibilities arising from future changes to specifications and product descriptions, which MACOM may make at any time, without notice. These materials grant no license, express or implied, to any intellectual property rights.

THESE MATERIALS ARE PROVIDED "AS IS" WITH NO WARRANTY OR LIABILITY, EXPRESS OR IMPLIED, RELATING TO SALE AND/OR USE OF MACOM PRODUCTS INCLUDING FITNESS FOR A PARTICULAR PURPOSE, MERCHANTABILITY, INFRINGEMENT OF INTELLECTUAL PROPERTY RIGHT, ACCURACY OR COMPLETENESS, OR SPECIAL, INDIRECT, INCIDENTAL, OR CONSEQUENTIAL DAMAGES WHICH MAY RESULT FROM USE OF THESE MATERIALS.

MACOM products are not intended for use in medical, lifesaving or life sustaining applications. MACOM customers using or selling MACOM products for use in such applications do so at their own risk and agree to fully indemnify MACOM for any damages resulting from such improper use or sale.