

8274

Multi-Protocol Serial Controller (MPSC)

The Intel 8274 Multi-Protocol Series Controller (MPSC) is designed to interface High Speed Communications Lines using Asynchronous, IBM Bisync, and SDLC/HDLC protocol to Intel microcomputer systems. It can be interfaced with Intel's MCS-48, -85, -51; iAPX-86, -88, -186 and -188 families, the 8237 DMA controller, or the 8089 I/O processor in polled, interrupt driven, or DMA driven modes of operation.

Rochester Electronics Manufactured Components

Rochester branded components are manufactured using either die/wafers purchased from the original suppliers or Rochester wafers recreated from the original IP. All recreations are done with the approval of the OCM.

Parts are tested using original factory test programs or Rochester developed test solutions to guarantee product meets or exceeds the OCM data sheet.

Quality Overview

- ISO-9001
- AS9120 certification
- Qualified Manufacturers List (QML) MIL-PRF-38535
 - Class Q Military
 - Class V Space Level
- Qualified Suppliers List of Distributors (QSLD)
 - Rochester is a critical supplier to DLA and meets all industry and DLA standards.

Rochester Electronics, LLC is committed to supplying products that satisfy customer expectations for quality and are equal to those originally supplied by industry manufacturers.

The original manufacturer's datasheet accompanying this document reflects the performance and specifications of the Rochester manufactured version of this device. Rochester Electronics guarantees the performance of its semiconductor products to the original OEM specifications. 'Typical' values are for reference purposes only. Certain minimum or maximum ratings may be based on product characterization, design, simulation, or sample testing.

MULTI-PROTOCOL SERIAL CONTROLLER (MPSC)

- **Asynchronous, Byte Synchronous and Bit Synchronous Operation**
- **Two Independent Full Duplex Transmitters and Receivers**
- **Fully Compatible with 8048, 8051, 8085, 8088, 8086, 80188 and 80186 CPU's; 8257 and 8237 DMA Controllers; and 8089 I/O Proc.**
- **4 Independent DMA Channels**
- **Baud Rate: DC to 880K Baud**
- **Asynchronous:**
 - 5–8 Bit Character; Odd, Even, or No Parity; 1, 1.5 or 2 Stop Bits
 - Error Detection: Framing, Overrun, and Parity
- **Byte Synchronous:**
 - Character Synchronization, Int. or Ext.
 - One or Two Sync Characters
 - Automatic CRC Generation and Checking (CRC-16)
 - IBM Bsync Compatible
- **Bit Synchronous:**
 - SDLC/HDLC Flag Generation and Recognition
 - 8 Bit Address Recognition
 - Automatic Zero Bit Insertion and Deletion
 - Automatic CRC Generation and Checking (CCITT-16)
 - CCITT X.25 Compatible
- **Available in EXPRESS and Military**

2

The Intel 8274 Multi-Protocol Series Controller (MPSC) is designed to interface High Speed Communications Lines using Asynchronous, IBM Bsync, and SDLC/HDLC protocol to Intel microcomputer systems. It can be interfaced with Intel's MCS-48, -85, -51; iAPX-86, -88, -186 and -188 families, the 8237 DMA Controller, or the 8089 I/O Processor in polled, interrupt driven, or DMA driven modes of operation.

The MPSC is a 40 pin device fabricated using Intel's High Performance HMOS TeFnoogy.

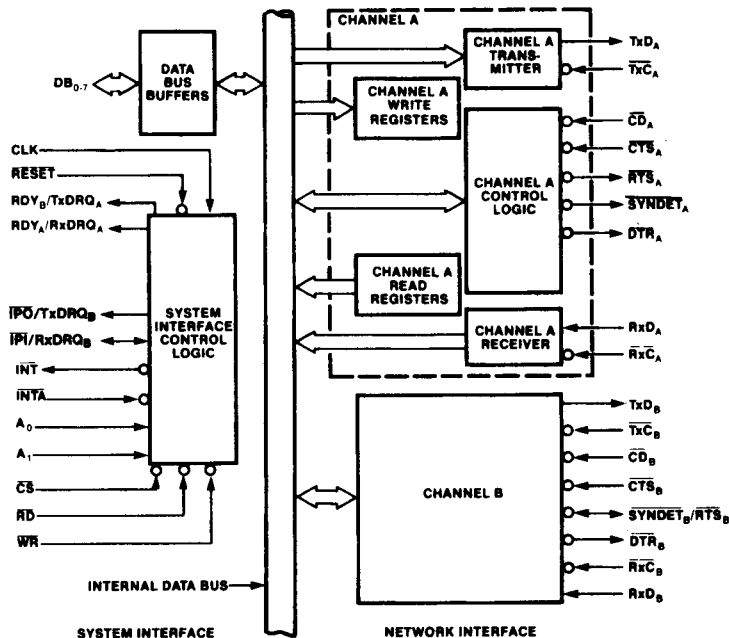

Figure 1. Block Diagram

170102-1

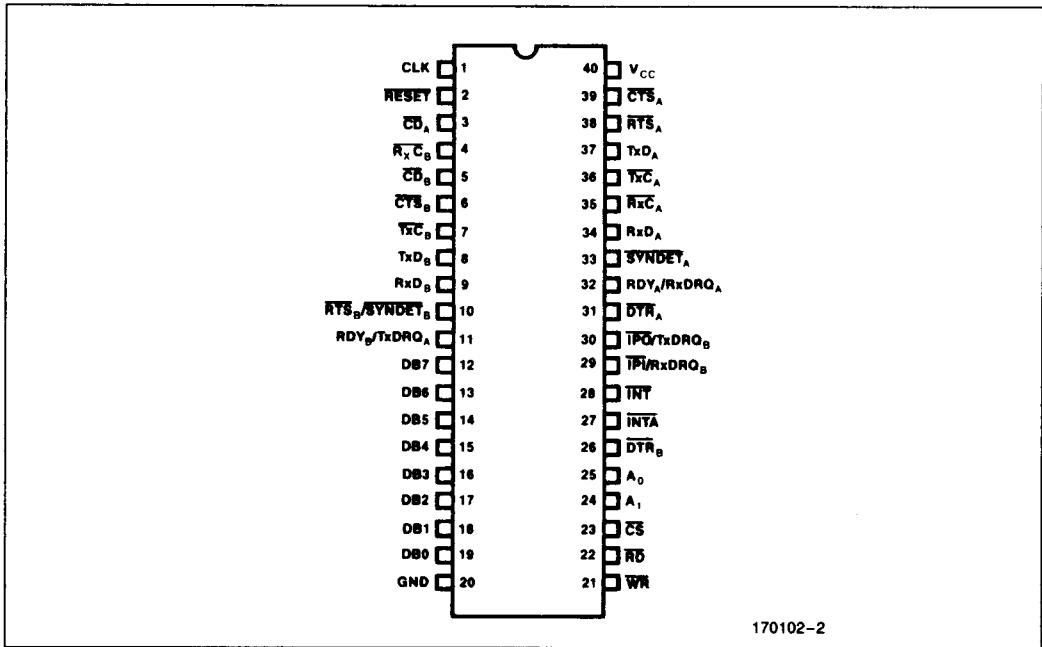

Figure 2. 8274 Pin Configuration (PDIP)

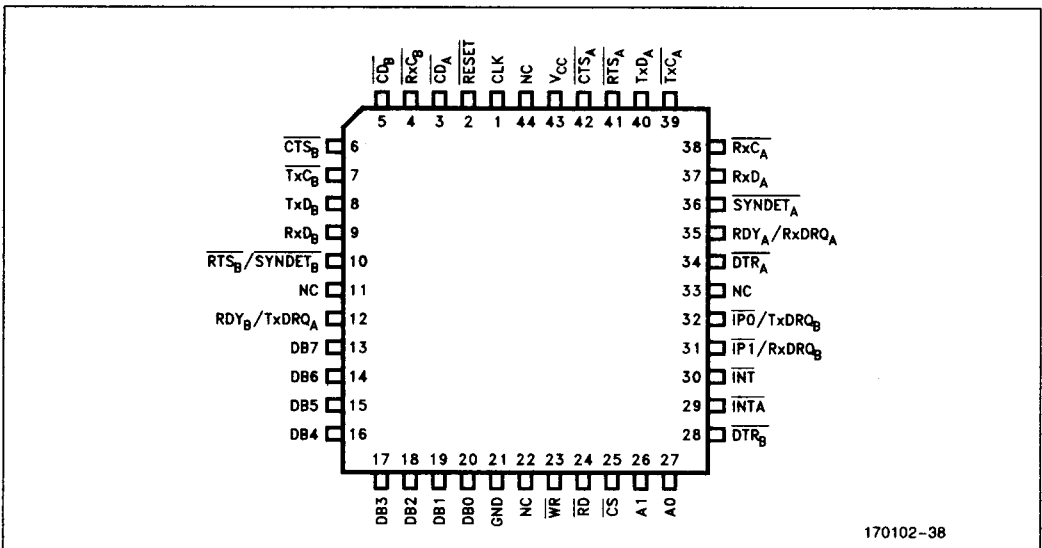

Figure 3. 8274 Pin Configuration (PLCC)

Table 1. Pin Description

Symbol	Pin No.	Type	Name and Function
CLK	1	I	CLOCK: System clock, TTL compatible.
$\overline{\text{RESET}}$	2	I	RESET: A low signal on this pin will force the MPSC to an idle state. TxDA and TxD_B are forced high. The modem interface output signals are forced high. The MPSC will remain idle until the control registers are initialized. Reset must be true for one complete CLK cycle.
$\overline{\text{CD}}_A$	3	I	CARRIER DETECT (CHANNEL A): This interface signal is supplied by the modem to indicate that a data carrier signal has been detected and that a valid data signal is present on the RxD_A line. If the auto enable control is set the 8274 will not enable the serial receiver until $\overline{\text{CD}}_A$ has been activated.
$\overline{\text{Rx}}\overline{\text{C}}_B$	4	I	RECEIVE CLOCK (CHANNEL B): The serial data are shifted into the Receive Data input (RxD_B) on the rising edge of the Receive Clock.
$\overline{\text{CD}}_B$	5	I	CARRIER DETECT (CHANNEL B): This interface signal is supplied by the modem to indicate that a data carrier signal has been detected and that a valid data signal is present on the RxD_B line. If the auto enable control is set the 8274 will not enable the serial receiver until $\overline{\text{CD}}_B$ has been activated.
$\overline{\text{CTS}}_B$	6	I	CLEAR TO SEND (CHANNEL B): This interface signal is supplied by the modem in response to an active $\overline{\text{RTS}}$ signal. $\overline{\text{CTS}}$ indicates that the data terminal/computer equipment is permitted to transmit data. In addition, if the auto enable control is set, the 8274 will not transmit data bytes until $\overline{\text{CTS}}$ has been activated.
$\overline{\text{TxC}}_B$	7	I	TRANSMIT CLOCK (CHANNEL B): The serial data are shifted out from the Transmit Data output (TxD_B) on the falling edge of the Transmit Clock.
TxD_B	8	O	TRANSMIT DATA (CHANNEL B): This pin transmits serial data to the communications channel (Channel B).
RxD_B	9	I	RECEIVE DATA (CHANNEL B): This pin receives serial data from the communications channel (Channel B).
$\overline{\text{SYNDET}}_B$ $\overline{\text{RTS}}_B$	10	I/O	SYNCHRONOUS DETECTION (CHANNEL B): This pin is used in byte synchronous mode as either an internal sync detect (output) or as a means to force external synchronization (input). In SDLC mode, this pin is an output indicating Flag detection. In asynchronous mode it is a general purpose input (Channel B). REQUEST TO SEND (CHANNEL B): General purpose output, generally used to signal that Channel B is ready to send data. When the RTS bit is reset in asynchronous mode, the signal does not go inactive (High) until the transmitter is empty. $\overline{\text{SYNDET}}_B$ or $\overline{\text{RTS}}_B$ selection is done by WR2; D7. (Channel A).

Table 1. Pin Description (Continued)

Symbol	Pin No.	Type	Name and Function
RDY _B / TxDRQ _A	11	O	READY (CHANNEL B)/TRANSMITTER DMA REQUEST (CHANNEL A): In mode 0 this pin is RDY _B and is used to synchronize data transfers between the processor and the MPSC (Channel B). In modes 1 and 2 this pin is TxDRQ _A and is used by the Channel A transmitter to request a DMA transfer.
DB7	12	I/O	DATA BUS: The Data Bus lines are bidirectional three state lines which interface with the system's Data Bus.
DB6	13		
DB5	14		
DB4	15		
DB3	16		
DB2	17		
DB1	18		
DB0	19		
GND	20		GROUND.
V _{CC}	40		POWER: +5V Supply
$\overline{\text{CTS}}_A$	39	I	CLEAR TO SEND (CHANNEL A): This interface signal is supplied by the Modem in response to an active RTS signal. $\overline{\text{CTS}}$ indicates that the data terminal/computer equipment is permitted to transmit data. In addition, if the auto enable control is set, the 8274 will not transmit data bytes until $\overline{\text{CTS}}$ has been activated.
RTS _A	38	O	REQUEST TO SEND (CHANNEL A): General purpose output commonly used to signal that Channel A is ready to send data. When the RTS bit is reset in asynchronous mode, the signal does not go inactive (High) until the transmitter is empty.
TxD _A	37	O	TRANSMIT DATA (CHANNEL A): This pin transmits serial data to the communications channel (Channel A).
$\overline{\text{TxC}}_A$	36	I	TRANSMIT CLOCK (CHANNEL A): The serial data are shifted out from the Transmit Data output (TxD _A) on the falling edge of the Transmit Clock.
$\overline{\text{RxC}}_A$	35	I	RECEIVE CLOCK (CHANNEL A): The serial data are shifted into the Receive Data input (RxD _A) on the rising edge of the Receive Clock.
RxD _A	34	I	RECEIVE DATA (CHANNEL A): This pin receives serial data from the communications channel (Channel A).
$\overline{\text{SYNDET}}_A$	33	I/O	SYNCHRONOUS DETECTION (CHANNEL A): This pin is used in byte synchronous mode as either an internal sync detect (output) or as a means to force external synchronization (input). In SDLC mode, this pin is an output indicating flag detection. In asynchronous mode it is a general purpose input (Channel A).

Table 1. Pin Description (Continued)

Symbol	Pin No.	Type	Name and Function
RDY _A / RxDRQ _A	32	O	READY: In mode 0 this pin is RDY _A and is used to synchronize data transfers between the processor and the MPSC (Channel A). In modes 1 and 2 this pin is RxDRQ _A and is used by the channel A receiver to request a DMA transfer.
DTR _A	31	O	DATA TERMINAL READY (CHANNEL A): General purpose output.
IPO/ TxDRQ _B	30	O	INTERRUPT PRIORITY OUT/TRANSMITTER DMA REQUEST (CHANNEL B): In modes 0 and 1, this pin is Interrupt Priority Out. It is used to establish a hardware interrupt priority scheme with IPI. It is low only if IPI is low and the controlling processor is not servicing an interrupt from this MPSC. In mode 2 it is TxDRQ _B and is used to request a DMA cycle for a transmit operation (Channel B).
IPI/ RxDRQ _B	29	I/O	INTERRUPT PRIORITY IN/RECEIVER DMA REQUEST (CHANNEL B): In modes 0 and 1, IPI is Interrupt Priority In. A low on IPI means that no higher priority device is being serviced by the controlling processor's interrupt service routine. In mode 2 this pin is RxDRQ _B and is used to request a DMA cycle for a receive operation (Channel B).
INT	28	O	INTERRUPT: The interrupt signal indicates that the highest priority internal interrupt requires service (open collector). Priority can be resolved via an external interrupt controller or a daisy-chain scheme.
INTA	27	I	INTERRUPT ACKNOWLEDGE: This Interrupt Acknowledge signal allows the highest priority interrupting device to generate an interrupt vector. This pin must be pulled high (inactive) in non-vector mode.
DTR _B	26	O	DATA TERMINAL READY (CHANNEL B): This is a general purpose output.
A ₀	25	I	ADDRESS: This line selects Channel A or B during data or command transfers. A low selects Channel A.
A ₁	24	I	ADDRESS: This line selects between data or command information transfer. A low means data.
CS	23	I	CHIP SELECT: This signal selects the MSPC and enables reading from or writing into registers.
RD	22	I	READ: Read controls a data byte or status byte transfer from the MPSC to the CPU.
WR	21	I	WRITE: Write controls transfer of data or commands to the MPSC.

RESET

When the 8274 RESET line is activated, both MPSC channels enter the idle state. The serial output lines are forced to the marking state (high) and the modem interface signals (RTS, DTR) are forced high. In addition, the pointers registers are set to zero.

GENERAL DESCRIPTION

The Intel 8274 Multi-Protocol Serial Controller is a microcomputer peripheral device which supports Asynchronous, Byte Synchronous (Monosync, IBM Bisync), and Bit Synchronous (ISO's HDLC, IBM's SDLC) protocols. This controller's flexible architecture allows easy implementation of many variations of these three protocols with low software and hardware overhead.

The Multi-Protocol Serial controller (MPSC) implements two independent serial receiver/transmitter channels.

The MPSC supports several microprocessor interface options: Polled, Wait, Interrupt driven and DMA driven. The MPSC is designed to support INTEL's MCS-85 and iAPX 86, 88, 186, 188 families.

FUNCTIONAL DESCRIPTION

Additional information on Asynchronous and Synchronous Communications with the 8274 is available respectively in the Applications Notes AP 134 and AP 145.

Command, parameter, and status information is stored in 21 registers within the MPSC (8 writable registers for each channel, 2 readable registers for Channel A and 3 readable registers for Channel B).

In the following discussion, the writable registers will be referred to as WRO through WR7 and the readable registers will be referred to as RRO through RR2.

This section of the data sheet describes how the Asynchronous and Synchronous protocols are implemented in the MPSC. It describes general considerations, transmit operation, and receive operation for Asynchronous, Byte Synchronous, and Bit Synchronous protocols.

ASYNCHRONOUS OPERATIONS

Transmitter/Receiver Initialization

(See Detailed Command Description Section for complete information)

In order to operate in asynchronous mode, each MPSC channel must be initialized with the following information:

1. Transmit/Receive Clock Rate. This parameter is specified by bits 6 and 7 of WR4. The clock rate may be set to 1, 16, 32, or 64 times the data-link bit rate. If the X1 clock mode is selected, the bit synchronization must be accomplished externally.
2. Number of Stop Bits. This parameter is specified by bits 2 and 3 of WR4. The number of stop bits may be set to 1, 1½, or 2.
3. Parity Selection. Parity may be set for odd, even, or no parity by bits 0 and 1 of WR4.
4. Receiver Character Length. This parameter sets the length of received characters to 5, 6, 7, or 8 bits. This parameter is specified by bits 6 and 7 of WR3.
5. Receiver Enable. The serial-channel receiver operation may be enabled or disabled by setting or clearing bit 0 of WR3.
6. Transmitter Character Length. This parameter sets the length of transmitted characters to 5, 6, 7, or 8 bits. This parameter is specified by bits 5 and 6 of WR5. Characters of less than 5 bits in length may be transmitted by setting the transmitted length to five bits (set bits 5 and 6 of WR5 to 0).

The MPSC then determines the actual number of bits to be transmitted from the character data byte. The bits to be transmitted must be right justified in the data byte, the next three bits must be set to 0 and all remaining bits must be set to 1. The following table illustrates the data formats for transmission of 1 to 5 bits of data.

Byte Written	Number of Bits Transmitted
D7 D6 D5 D4 D3 D2 D1 D0	(Character Length)
1 1 1 1 0 0 0 c	1
1 1 1 0 0 0 c c	2
1 1 0 0 0 c c c	3
1 0 0 0 c c c c	4
0 0 0 c c c c c	5

7. Transmitter Enable. The serial channel transmitter operation may be enabled or disabled by setting or clearing bit 3 of WR5.
8. Interrupt Mode. Specified by bits 3 and 4 of WR1.

For data transmission via a modem or RS-232-C interface, the following information must also be specified:

1. The Request To Send (RTS) (WR5; D1) and Data Terminal Ready (DTR) (WR5; D7) bits must be set along with the Transmit Enable bit (WR5; D3).
2. Auto Enable may be set to allow the MPSC to automatically enable the channel transmitter when the clear-to-send signal is active and to automatically enable the receiver when the carrier-detect signal is active. However, the Transmit Enable bit (WR3; D3) and Receive Enable bit (WR3; D1) must be set in order to use the Auto Enable mode. Auto Enable is controlled by bit 5 of WR3.

When loading Initialization parameters into the MPSC, WR4 information must be written before the WR1, WR3, WR5 parameters commands.

During initialization, it is desirable to guarantee that the external/status latches reflect the latest interface information. Since up to two state changes are internally stored by the MPSC, at least two Reset External/Status Interrupt commands must be issued. This procedure is most easily accomplished by simply issuing this reset command whenever the pointer register is set during initialization.

An MPSC initialization procedure (MPSC\$RX\$INIT) for asynchronous communication is listed in Intel Application Note AP 134.

TRANSMIT

The transmit function begins when the Transmit Enable bit (WR5; D3) is set. The MPSC automatically adds the start bit, the programmed parity bit (odd, even or no parity) and the programmed number of stop bits (1, 1.5 or 2 bits) to the data character being transmitted. 1.5 stop bits option must be used with X16, X32 or X64 clock options only. The data character is transmitted least significant bit first.

The serial data are shifted out from the Transmit Data (TxD) output on the falling edge of the Transmit Clock (TxC) input at a rate programmable to 1, $\frac{1}{16}$ th, $\frac{1}{32}$ nd, or $\frac{1}{64}$ th of the clock rate supplied to the TxC input.

The TxD output is held high when the transmitter has no data to send, unless, under program control, the Send Break (WR5; D4) command is issued to hold the TxD low.

If the External/Status Interrupt bit (WR1; D0) is set, the status of CD, CTS and SYNDET are monitored and, if any changes occur for a period of time greater than the minimum specified pulse width, an interrupt is generated. CTS is usually monitored using this interrupt feature (e.g., Auto Enable option).

The Transmit Buffer Empty bit (RRO; D2) is set by the MPSC when the data byte from the buffer is loaded in the transmit shift register. Data should be written to the MPSC only when the Tx buffer becomes empty to prevent overwriting.

Receive

The receive function begins when the Receive Enable (WR3; D0) bit is set. If the Auto Enable (WR3; D5) option is selected, then Carrier Detect (CD) must also be low. A valid start bit is detected if a low persists for at least $\frac{1}{2}$ bit time on the Receive Data (RxD) input.

The data is sampled at mid-bit time, on the rising edge of RxC, until the entire character is assembled. The receiver inserts 1's when a character is less than 8 bits. If parity (WR4; D0) is enabled and the character is less than 8 bits the parity bit is not stripped from the character.

2

Error Reporting

The receiver also stores error status for each of the 3 data characters in the data buffer. Three error conditions may be encountered during data reception in the asynchronous mode:

1. **Parity.** If parity bits are computed and transmitted with each character and the MPSC is set to check parity (bit 0 in WR4 is set), a parity error will occur whenever the number of "1" bits within the character (including the parity bit) does not match the odd/even setting of the parity check flag (bit 1 in WR4). When a parity error is detected, the parity error flag (RR1; D4) is set and remains set until it is reset by the Error Reset command (WR0; D5, D4, D3).
2. **Framing.** A framing error will occur if a stop bit is not detected immediately following the parity bit (if parity checking is enabled) or immediately following the most-significant data bit (if parity checking is not enabled). When a Framing Error is detected, the Framing Error bit (RR1; D6) is set and remains set until reset by the Error Reset Command (WR0; D5, D4, D3). The detection of a Framing Error adds an additional $\frac{1}{2}$ bit time to the character time so the Framing Error is not interpreted as a new start bit.
3. **Overrun.** If the CPU fails to read a data character while more than three characters have been received, the Receive Overrun bit (RR1; D5) is set. When this occurs, the fourth character assembled replaces the third character in the receive buffers. Only the overwritten character is flagged with the Receive Overrun bit. The Receive Overrun bit (RR1; D5) is reset by the Error Reset command (WR0; D5, D4, D3).

External/Status Latches

The MPSC continuously monitors the state of five external/status conditions:

1. CTS—clear-to-send input pin.
2. CD—carrier-detect input pin.
3. SYNDET—sync-detect input pin. This pin may be used as a general-purpose input in the asynchronous communication mode.
4. BREAK—a break condition (series of space bits on the receiver input pin).
5. TxUNDERRUN/EOM—Transmitter Underrun/End of Message.

A change of state in any of these monitored conditions will cause the associated status bit in RR0 to be latched (and optionally cause an interrupt).

If the External/Status Interrupt bit (WR1; D0) is enabled, Break Detect (RR0; D7) and Carrier Detect (RR0; D3) will cause an interrupt. Reset Ex-

ternal/Status interrupts (WR0; D5, D4, D3) will clear Break Detect and Carrier Detect bits if they are set.

Command, parameter, and status information is stored in 21 registers within the MPSC (8 writable registers for each channel, 2 readable registers for Channel A and 3 readable registers for Channel B). They are all accessed via the command ports.

An internal pointer register selects which of the command or status registers will be read or written during a command/status access of an MPSC channel.

After reset, the contents of the pointer registers are zero. The first write to a command register causes the data to be loaded into Write Register 0 (WR0). The three least significant bits of WR0 are loaded into the Command/Status Pointer. The next read or write operation accesses the read or write register selected by the pointer. The pointer is reset after the read or write operation is completed.

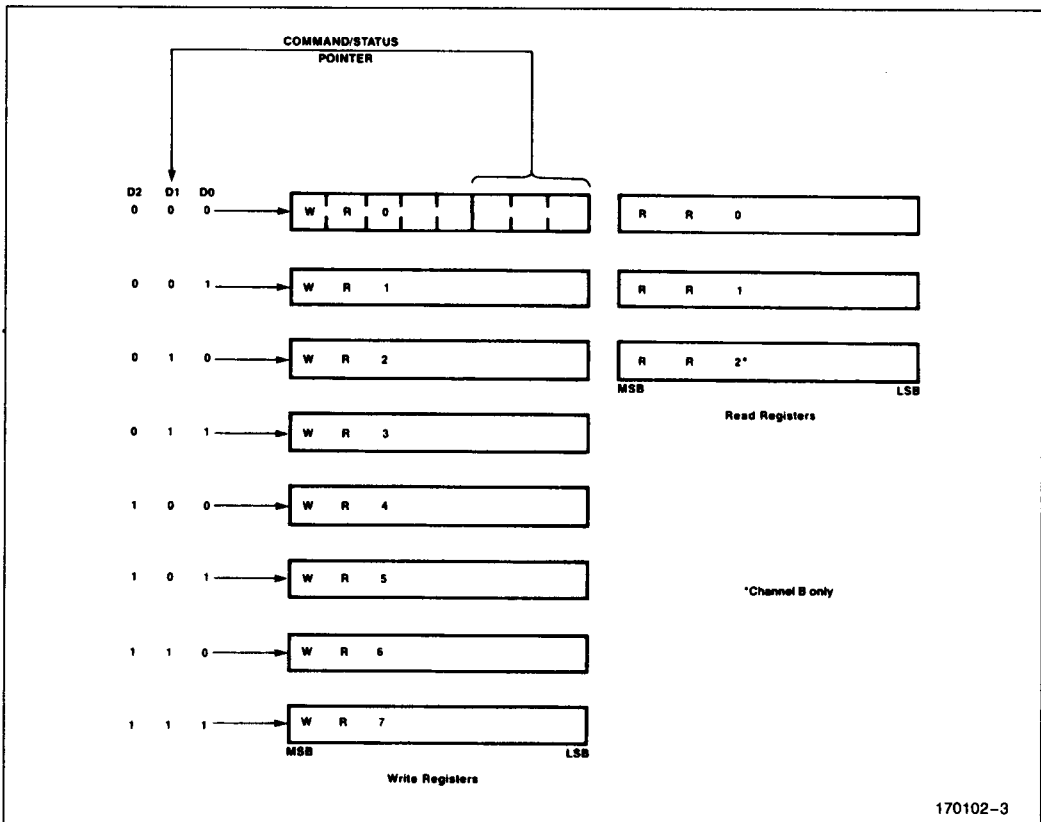

Figure 4. Command/Status Register Architecture (each serial channel)

Asynchronous Mode Register Setup

	D7	D6	D5	D4	D3	D2	D1	D0	
WR3	00	Rx 5 b/char		AUTO ENABLE	0	0	0	Rx ENABLE	
	01	Rx 7 b/char							
	10	Tx 6 b/char							
	11	Rx 8 b/char							
WR4	00	X1 Clock		0	0	01 1 STOP BIT 10 1½ STOP BITS 11 2 STOP BITS	EVEN/ ODD PARITY	PARITY ENABLE	
	01	X16 Clock							
	10	X32 Clock							
	11	X64 Clock							
WR5	DTR	00	Tx ≤ 5 b/char		SEND BREAK	Tx ENABLE	0	RTS	0
		01	Tx 7 b/char						
		10	Tx 6 b/char						
		11	Tx 8 b/char						

2

**SYNCHRONOUS OPERATION—
MONOSYNC, BISYNC**

General

The MPSC must be initialized with the following parameters: odd or even parity (WR4; D1, D0), X1 clock mode (WR4; D7, D6), 8- or 16-bit sync character (WR4; D5, D4), CRC polynomial (WR5; D2), Transmitter Enable (WR5; D3), interrupt modes (WR1, WR2), transmit character length (WR5; D6, D5) and receive character length (WR3; D7, D6). WR4 parameters must be written before WR1, WR3, WR5, WR6 and WR7.

The data is transmitted on the falling edge of the Transmit Clock, (Tx \bar{C}) and is received on the rising edge of Receive Clock (Rx \bar{C}). The X1 clock is used for both transmit and receive operations for all three sync modes: Mono, Bi and External.

Transmit Set-Up—Monosync, Bisync

Transmit data is held high after channel reset, or if the transmitter is not enabled. A break may be programmed to generate a spacing line that begins as soon as the Send Break (WR5; D4) bit is set. With the transmitter fully initialized and enabled, the default condition is continuous transmission of the 8- or 16-bit sync character.

Using interrupts for data transfer requires that the Transmit Interrupt/DMA Enable bit (WR1; D1) be set. An interrupt is generated each time the transmit buffer becomes empty. The interrupt can be satisfied either by writing another character into the transmitter or by resetting the Transmitter Interrupt/DMA Pending latch with a Reset Transmitter Inter-

Synchronous Mode Register Setup—Monosync, Bisync

	D7	D6	D5	D4	D3	D2	D1	D0	
WR3	00	Rx 5 b/char		ENTER HUNT MODE	Rx CRC ENABLE	0	SYNC CHAR LOAD INHIBIT	Rx ENABLE	
	01	Rx 7 b/char							
	10	Tx 6 b/char							
	11	Rx 8 b/char							
WR4	0	0	00	8 bit Sync		0	0	EVEN/ ODD PARITY	PARITY ENABLE
			01	16 bit Sync					
			11	Ext Sync					
WR5	DTR	00	Tx ≤ 5 b/char		SEND BREAK	Tx ENABLE	1 (SELECTS CRC-16)	RTS	Tx CRC ENABLE
		01	Tx 7 b/char						
		10	Tx 6 b/char						
		11	Tx 8 b/char						

rupt/DMA Pending Command (WR0; D5, D4, D3). If nothing more is written into the transmitter, there can be no further Transmit Buffer Empty interrupt, but this situation does cause a Transmit Underrun condition (RR0; D6).

Data Transfers using the RDY signal are for software controlled data transfers such as block moves. RDY tells the CPU that the MPSC is not ready to accept/provide data and that the CPU must extend the output/input cycle. DMA data transfers use the TxDRQ A/B signals which indicate that the transmit buffer is empty, and that the MPSC is ready to accept the next data character. If the data character is not loaded into the MPSC by the time the transmit shift register is empty, the MPSC enters the Transmit Underrun condition.

The MPSC has two programmable options for solving the transmit underrun condition: it can insert sync characters, or it can send the CRC characters generated so far, followed by sync characters. Following a chip or channel reset, the Transmit Underrun/EOM status bit (RR0; D6) is in a set condition allowing the insertion of sync characters when there is no data to send. The CRC is not calculated on these automatically inserted sync characters. When the CPU detects the end message, a Reset Transmit Underrun/EOM command can be issued. This allows CRC to be sent when the transmitter has no data to send.

In the case of sync insertion, an interrupt is generated only after the first automatically inserted sync character has been loaded in the Transmit Shift Register. The status register indicates the Transmit Underrun/EOM bit and the Transmit Buffer Empty bit are set.

In the case of CRC insertion, the Transmit Underrun/EOM bit is set and the Transmit Buffer Empty bit is reset while CRC is being sent. When CRC has been completely sent, the Transmit Buffer Empty status bit is set and an interrupt is generated to indicate to the CPU that another message can begin (this interrupt occurs because CRC has been sent and sync has been loaded into the Tx Shift Register). If no more messages are to be sent, the program can terminate transmission by resetting RTS, and disabling the transmitter (WR5; D3).

Bisync CRC Generation. Setting the Transmit CRC enable bit (WR5; D0) indicates CRC accumulation when the program sends the first data character to the MPSC. Although the MPSC automatically transmits up to two sync characters (16 bit sync), it is wise to send a few more sync characters ahead of the message (before enabling Transmit CRC) to ensure synchronization at the receiving end.

The Transmit CRC Enable bit can be changed on the fly any time in the message to include or exclude a particular data character from CRC accumulation. The Transmit CRC Enable bit should be in the desired state when the data character is loaded into the transmit shift register. To ensure this bit in the proper state, the Transmit CRC Enable bit must be issued before sending the data character to the MPSC.

Transmit Transparent Mode. Transparent mode (Bisync protocol) operation is made possible by the ability to change Transmit CRC Enable on the fly and by the additional capability of inserting 16 bit sync characters. Exclusion of DLE characters from CRC calculation can be achieved by disabling CRC calculation immediately preceding the DLE character transfer to the MPSC.

In the transmit mode, the transmitter always sends the programmed number of sync bits (8 or 16) (WR4; D5, D4). When in the Monosync mode, the transmitter sends from WR6 and the receiver compares against WR7. One or two CRC polynomials, CRC 16 or SDLC, may be used with synchronous modes. In the transmit initialization process, the CRC generator is initialized by setting the Reset Transmit CRC Generator command (WR0; D7, D6).

The External/Status interrupt (WR1; D0) mode can be used to monitor the status of the $\overline{\text{CTS}}$ input as well as the Transmit Underrun/EOM latch. Optionally, the Auto Enable (WR3; D5) feature can be used to enable the transmitter when $\overline{\text{CTS}}$ is active. The first data transfer to the MPSC can begin when the External/Status interrupt (CTS (RR0; D5) status bit set) occurs following the Transmit Enable command (WR5; D3).

Receive

After a channel reset, the receiver is in the Hunt phase, during which the MPSC looks for character synchronization. The Hunt begins only when the receiver is enabled and data transfer begins only when character synchronization has been achieved. If character synchronization is lost, the hunt phase can be re-entered by writing the Enter Hunt Phase (WR3; D4) bit. The assembly of received data continues until the MPSC is reset or until the receiver is disabled (by command or by $\overline{\text{CD}}$ while in the Auto Enables mode) or until the CPU sets the Enter Hunt Phase bit. Under program control, all the leading sync characters of the message can be inhibited from loading the receive buffers by setting the Sync Character Load Inhibit (WR3; D1) bit. After character synchronization is achieved the assembled characters are transferred to the receive data FIFO. After

receiving the first data character, the Sync Character Load Inhibit bit should be reset to zero so that all characters are received, including the sync characters. This is important because the received CRC may look like a sync character and not get received.

Data may be transferred with or without interrupts. Transferring data without interrupts is used for a purely polled operation or for off-line conditions. There are two interrupt modes available for data transfer: Interrupt on First Character Only and Interrupt on Every Character.

Interrupt on First Character Only mode is normally used to start a polling loop, a block transfer sequence using RDY to synchronize the CPU to the incoming data rate, or a DMA transfer using the RxDRQ signal. The MPSC interrupts on the first character and thereafter only interrupts after a Special Receive Condition is detected. This mode can be reinitialized using the Enable Interrupt On Next Receive Character (WR0; D5, D4, D3) command which allows the next character received to generate an interrupt. Parity Errors do not cause interrupts, but End of Frame (SDLC operation) and Receive Overrun do cause interrupts in this mode. If the external status interrupts (WR1; D0) are enabled an interrupt may be generated any time the \overline{CD} changes state.

Interrupt On Every Character mode generates an interrupt whenever a character enters the receive buffer. Errors and Special Receive Conditions generate a special vector if the Status Affects Vector (WR1B; D2) is selected. Also the Parity Error may be programmed (WR1; D4, D3) not to generate the special vector while in the Interrupt On Every Character mode.

The Special Receive Condition interrupt can only occur while in the Receive Interrupt On First Character Only or the Interrupt On Every Receive Character

modes. The Special Receive Condition interrupt is caused by the Receive Overrun (RR1; D5) error condition. The error status reflects an error in the current word in the receive buffer, in addition to any Parity or Overrun errors since the last Error Reset (WR0; D5, D4, D3). The Receive Overrun and Parity error status bits are latched and can only be reset by the Error Reset (WR0; D5, D4, D3) command.

The CRC check result may be obtained by checking for CRC bit (RR1; D6). This bit gives the valid CRC result 16 bit times after the second CRC byte has been read from the MPSC. After reading the second CRC byte, the user software must read two more characters (may be sync characters) before checking for CRC result in RR1. Also for proper CRC computation by the receiver, the user software must reset the Receive CRC Checker (WR0; D7, D6) after receiving the first valid data character. The receive CRC Enable bit (WR3; D3) may also be enabled at this time.



SYNCHRONOUS OPERATION—SDLC

General

Like the other synchronous operations the SDLC mode must be initialized with the following parameters: SDLC mode (WR4; D5, D4), SDLC polynomial (WR5; D2), Request to Send, Data Terminal Ready, transmit character length (WR5; D6, D5), interrupt modes (WR1; WR2), Transmit Enable (WR5; D3), Receive Enable (WR3; D0), Auto Enable (WR3; D5) and External/Status Interrupt (WR1; D0). WR4 parameters must be written before WR1, WR3, WR5, WR6 and WR7.

The Interrupt modes for SDLC operation are similar to those discussed previously in the synchronous operations section.

Synchronous Mode Register Setup—SDLC/HDLC

	D7	D6	D5	D4	D3	D2	D1	D0
WR3	00 Rx 5 b/char 01 Rx 7 b/char 10 Rx 6 b/char 11 Rx 8 b/char		AUTO ENABLES	ENTER HUNT MODE	Rx CRC ENABLE	ADDRESS SEARCH MODE	0	Rx
WR4	0	0	1 0 (SELECTS SDLC/ HDLC MODE)		0	0	0	0
WR5	DTR	00 Tx ≤ 5 b/char 01 Tx 7 b/char 10 Tx 6 b/char 11 Tx 8 b/char		SEND BREAK	Tx ENABLE	0 (SELECTS SDLC/HDLC CRC)	RTS	Tx CRC ENABLE

Transmit

After a channel reset, the MPSC begins sending SDLC flags.

Following the flags in an SDLC operation the 8-bit address field, control field and information field may be sent to the MPSC by the microprocessor. The MPSC transmits the Frame Check Sequence using the Transmit Underrun feature. The MPSC automatically inserts a zero after every sequence of 5 consecutive 1's except when transmitting Flags or Aborts.

SDLC—like protocols do not have provision for fill characters within a message. The MPSC therefore automatically terminates an SDLC frame when the transmit data buffer and output shift register have no more bits to send. It does this by sending the two bytes of CRC and then one or more flags. This allows very high-speed transmissions under DMA or CPU control without requiring the CPU to respond quickly to the end-of-message situation.

After a reset, the Transmit Underrun/EOM status bit is in the set state and prevents the insertion of CRC characters during the time there is no data to send. Flag characters are sent. The MPSC begins to send the frame when data is written into the transmit buffer. Between the time the first data byte is written, and the end of the message, the Reset Transmit Underrun/EOM (WR0; D7, D6) command must be issued. The Transmit Underrun/EOM status bit (RR0; D6) is in the reset state at the end of the message which automatically sends the CRC characters.

The MPSC may be programmed to issue a Send Abort command (WR0; D5, D4, D3). This command causes at least eight 1's but less than fourteen 1's to be sent before the line reverts to continuous flags.

Receive

After initialization, the MPSC enters the Hunt phase, and remains in the Hunt phase until the first Flag is received. The MPSC never again enters the Hunt phase unless the microprocessor writes the Enter Hunt command. The MPSC will also detect flags separated by a single zero. For example, the bit pattern 011111101111110 will be detected as two flags.

The MPSC can be programmed to receive all frames or it can be programmed to the Address Search Mode. In the Address Search Mode, only frames with addresses that match the value in WR6 or the global address (OFFH) are received by the MPSC. Extended address recognition must be done by the microprocessor software.

The control and information fields are received as data.

SDLC/HDLC CRC calculation does not have an 8-bit delay, since all characters are included in the calculation, unlike Byte Synchronous Protocols.

Reception of an abort sequence (7 or more 1's) will cause the Break/Abort bit (RR0; D7) to be set and will cause an External/Status interrupt, if enabled. After the Reset External/Status Interrupts Command has been issued, a second interrupt will occur at the end of the abort sequence.

MPSC

Detailed Command/Status Description

GENERAL

The MPSC supports an extremely flexible set of serial and system interface modes.

The system interface to the CPU consists of 8 ports or buffers:

CS	A ₁	A ₀	Read Operation	Write Operation
0	0	0	Ch. A Data Read	Ch. A Data Write
0	1	0	Ch. A Status Read	Ch. A Command/Parameter
0	0	1	Ch. B Data Read	Ch. B Data Write
0	1	1	Ch. B Status Read	Ch. B Command/Parameter
1	X	X	High Impedance	High Impedance

Data buffers are addressed by A₁ = 0, and Command ports are addressed by A₁ = 1.

COMMAND/STATUS DESCRIPTION

The following command and status bytes are used during initialization and execution phases of operation. All Command/Status operations on the two channels are identical, and independent, except where noted.

Detailed Register Description

Write Register 0 (WR0):

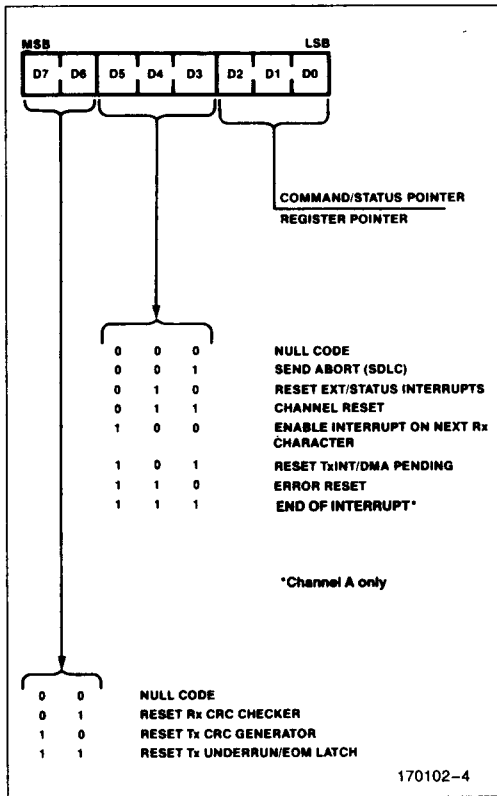

WR0

D2, D1, D0—Command/Status Register Pointer bits determine which write-register the next byte is to be written into, or which read-register the next byte is to be read from. After reset, the first byte written into either channel goes into WR0. Following a read or write to any register (except WR0) the pointer will point to WR0.

D5, D4, D3—Command bits determine which of the basic seven commands are to be performed.

Command 0 Null—has no effect.

Command 1 Send Abort—causes the generation of eight to thirteen 1's when in the SDLC mode.

Command 2 Reset External/Status Interrupts—resets the latched status bits of RR0 and re-enables them, allowing interrupts to occur again.

Command 3 Channel Reset—resets the Latched Status bits of RR0, the interrupt prioritization logic and all control registers for the channel. Four extra system clock cycles should be allowed for MPSC reset time before any additional commands or controls are written into the channel.

Command 4 Enable Interrupt on Next Receive Character—if the Interrupt on First Receive Character mode is selected, this command reactivates that mode after each complete message is received to prepare the MPSC for the next message.

Command 5 Reset Transmitter Interrupt/DMA Pending—if The Transmit Interrupt/DMA Enable mode is selected, the MPSC automatically interrupts or requests DMA data transfer when the transmit buffer becomes empty. When there are no more characters to be sent, issuing this command prevents further transmitter interrupts or DMA requests until the next character has been completely sent.

Command 6 Error Reset—error latches, Parity and Overrun errors in RR1 are reset.

Command 7 End of Interrupt—resets the interrupt-in-service latch of the highest-priority internal device under service.

D7, D6 CRC Reset Code.

00 Null—has no effect.

01 Reset Receive CRC Checker—resets the CRC checker to 0's. If in SDLC mode the CRC checker is initialized to all 1's.

10 Reset Transmit CRC Generator—resets the CRC generator to 0's. If in SDLC mode the CRC generator's initialized to all 1's.

11 Reset Tx Underrun/End of Message Latch.



Write Register 1 (WR1):

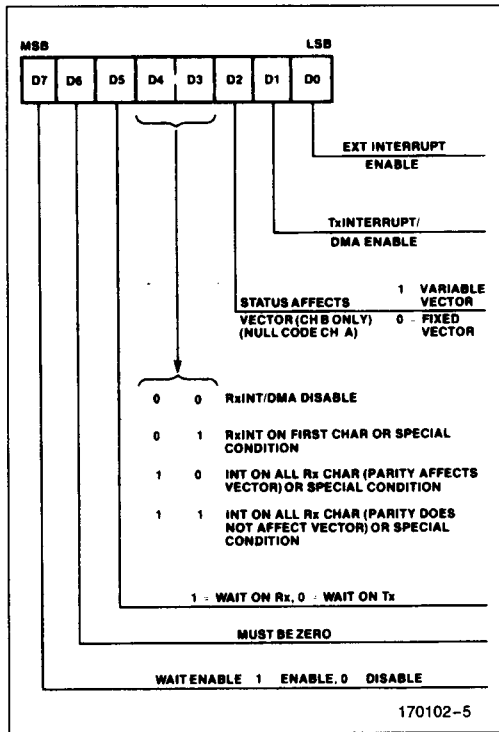

WR1

- D0 External/Status Interrupt Enable—allows interrupt to occur as the result of transitions on the CD, CTS or SYNDET inputs. Also allows interrupts as the result of a Break/Abort detection and termination, or at the beginning of CRC, or sync character transmission when the Transmit Underrun/EOM latch becomes set.
- D1 Transmitter Interrupt/DMA Enable—allows the MPSC to interrupt or request a DMA transfer when the transmitter buffer becomes empty.
- D2 Status Affects vector—(WR1, D2 active in channel B only.) If this bit is not set, then the fixed vector, programmed in WR2, is returned from an interrupt acknowledge sequence. If the bit is set then the vector returned from an interrupt acknowledge is variable as shown in the Interrupt Vector Table.

- D4, D3 Receive Interrupt Mode.
 - 0 0 Receive Interrupts/DMA Disabled.
 - 0 1 Receive Interrupt on First Character Only or Special Condition.
 - 1 0 Interrupt on All Receive Characters or Special Condition (Parity Error is a Special Receive Condition).
 - 1 1 Interrupt on All Receive Characters or Special Condition (Parity Error is not a Special Receive Condition).
- D5 Wait on Receive/Transmit—when the following conditions are met the RDY pin is activated, otherwise it is held in the High-Z state. (Conditions: Interrupt Enabled Mode, Wait Enabled, CS = 0, A0 = 0/1, and A1 = 0). The RDY pin is pulled low when the transmitter buffer is full or the receiver buffer is empty and it is driven High when the transmitter buffer is empty or the receiver buffer is full. The RDY_A and RDY_B may be wired OR connected since only one signal is active at any one time while the other is in the High Z state.
- D6 Must be Zero.
- D7 Wait Enable—enables the wait function.

WR2

- D1, D0 System Configuration—These specify the data transfer from MPSC channels to the CPU, either interrupt or DMA based.
 - 0 0 Channel A and Channel B both use interrupts.
 - 0 1 Channel A uses DMA, Channel B uses interrupts.
 - 1 0 Channel A and Channel B both use DMA.
 - 1 1 Illegal Code.
- D2 Priority—this bit specifies the relative priorities of the internal MPSC interrupt/DMA sources.
 - 0 (Highest) RxA, TxA, RxB, TxB, ExTA, ExTB (Lowest).
 - 1 (Highest) RxA, RxB, TxA, TxB, ExTA, ExTB (Lowest).
- D5, D4, D3 Interrupt Code—specifies the behavior of the MPSC when it receives an interrupt acknowledge sequence from the CPU. (See Interrupt Vector Mode Table.)

0 X X	Non-vectored interrupts—intended for use with external DMA CONTROLLER. The Data Bus remains in a high impedance state during INTA sequences.	1 0 1	8085 Vector Mode 2—intended for use as any secondary MPSC in a daisy chained priority structure. (See System Interface section).
1 0 0	8085 Vector Mode 1—intended for use as the primary MPSC in a daisy chained priority structure. (See System Interface section).	1 1 0	8086/88 Vector Mode—intended for use as either a primary or secondary in a daisy chained priority structure. (See System Interface section).
		D6	Must be zero.
		D7	zero Pin 10 = \overline{RTS}_B one Pin 10 = \overline{SYNDET}_B

Write Register 2 (WR2): Channel A Only

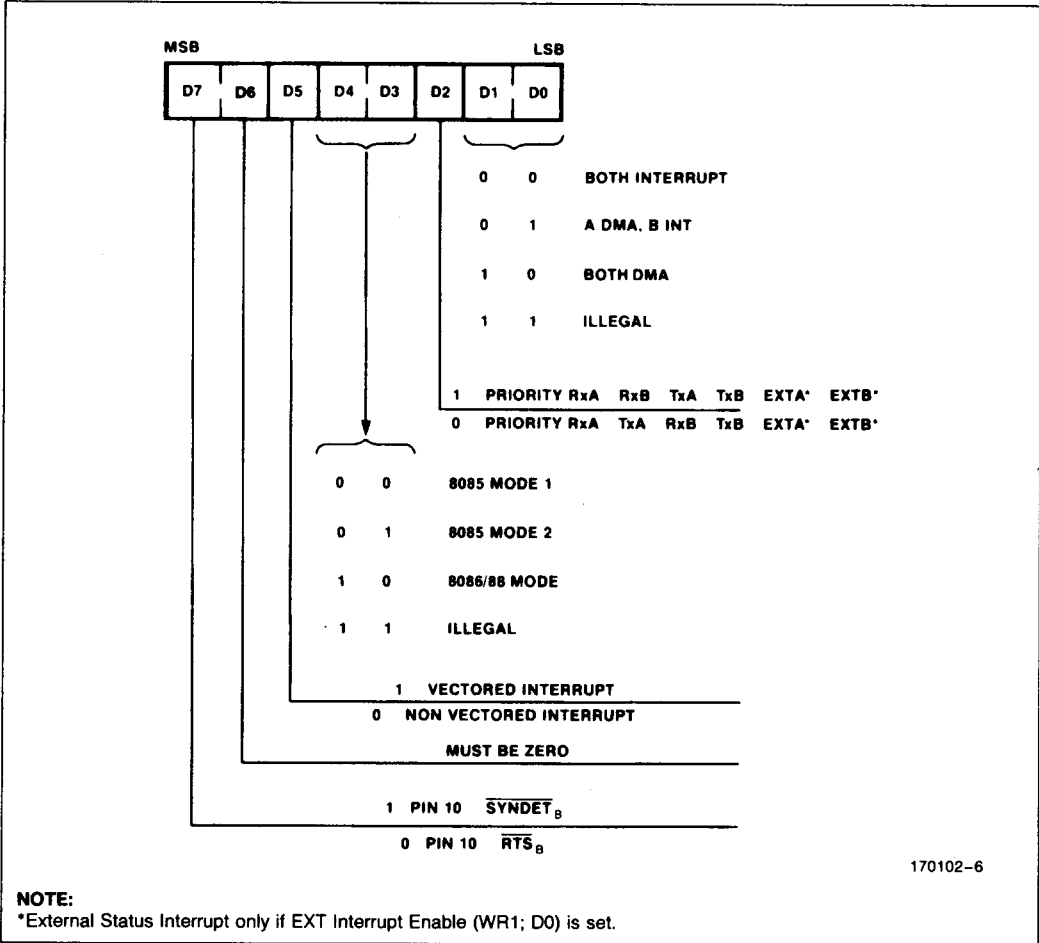

The following table describes the MPSC's response to an interrupt acknowledge sequence:

D5	D4	D3	IPI	MODE	INTA	Data Bus							
0	X	X	X	Non-vectorred	Any INTA	D7 High Impedance D0							
1	0	0	0	85 Mode 1	1st INTA 2nd INTA 3rd INTA	1 V7 0	1 V6 0	0 V5 0	0 V4* 0	1 V3* 0	1 V2* 0	0 V1 0	1 V0 0
1	0	0	1	85 Mode 1	1st INTA 2nd INTA 3rd INTA	1 High Impedance High Impedance	1 High Impedance High Impedance	0 High Impedance High Impedance	0 High Impedance High Impedance	1 High Impedance High Impedance	1 High Impedance High Impedance	0 High Impedance High Impedance	1 High Impedance High Impedance
1	1	0	0	86 Mode	1st INTA 2nd INTA	High Impedance V7 V6 V5 V4 V3 V2* V1* V0*	High Impedance V7 V6 V5 V4 V3 V2* V1* V0*	High Impedance V7 V6 V5 V4 V3 V2* V1* V0*	High Impedance V7 V6 V5 V4 V3 V2* V1* V0*	High Impedance V7 V6 V5 V4 V3 V2* V1* V0*	High Impedance V7 V6 V5 V4 V3 V2* V1* V0*	High Impedance V7 V6 V5 V4 V3 V2* V1* V0*	High Impedance V7 V6 V5 V4 V3 V2* V1* V0*
1	0	1	0	85 Mode 2	1st INTA 2nd INTA 3rd INTA	High Impedance V7 V6 V5 V4* V3* V2* V1 V0	High Impedance V7 V6 V5 V4* V3* V2* V1 V0	High Impedance V7 V6 V5 V4* V3* V2* V1 V0	High Impedance V7 V6 V5 V4* V3* V2* V1 V0	High Impedance V7 V6 V5 V4* V3* V2* V1 V0	High Impedance V7 V6 V5 V4* V3* V2* V1 V0	High Impedance V7 V6 V5 V4* V3* V2* V1 V0	High Impedance V7 V6 V5 V4* V3* V2* V1 V0
1	0	1	1	85 Mode 2	1st INTA 2nd INTA 3rd INTA	High Impedance High Impedance High Impedance	High Impedance High Impedance High Impedance	High Impedance High Impedance High Impedance	High Impedance High Impedance High Impedance	High Impedance High Impedance High Impedance	High Impedance High Impedance High Impedance	High Impedance High Impedance High Impedance	High Impedance High Impedance High Impedance
1	1	0	1	86 Mode	1st INTA 2nd INTA	High Impedance High Impedance	High Impedance High Impedance	High Impedance High Impedance	High Impedance High Impedance	High Impedance High Impedance	High Impedance High Impedance	High Impedance High Impedance	High Impedance High Impedance

NOTE:

*These bits are variable if the "status affects vector" mode has been programmed, (WR1B, D2).

Interrupt/DMA Mode, Pin Functions, and Priority

Ch. A WR2			Int/DMA Mode		Pin Functions				Priority	
					RDY _A / RxDRQ _A Pin 32	RDY _B / TxDRQ _A Pin 11	PIP/ RxDRQ _B Pin 29	IPO/ TxDRQ _B Pin 30		
D ₂	D ₁	D ₀	CH. A	CH. B						
0	0	0	INT	INT	RDY _A	RDY _B	IPI	IPO	Rx _A , Tx _A , Rx _B , Tx _B , EXT _A , EXT _B	
1	0	0	INT	INT					Rx _A , Rx _B , Tx _A , Tx _B , EXT _A , EXT _B	
0	0	1	DMA		RxDRQ _A	TxDRQ _A	IPI	IPO	Rx _A , Tx _A (DMA)	
				INT					Rx _A (¹), Rx _B , Tx _B , EXT _A , EXT _B (INT)	
1	0	1	DMA						Rx _A , Tx _A (DMA)	
				INT					Rx _A (¹), Rx _B , Tx _B , EXT _A , EXT _B (INT)	
0	1	0	DMA	DMA	RxDRQ _A	TxDRQ _A	RxDRQ _B	TxDRQ _B	Rx _A , Tx _A , Rx _B , Tx _B (DMA)	
									Rx _A (¹), Rx _B (¹), EXT _A , EXT _B (INT)	
1	1	0	DMA	DMA					Rx _A , Rx _B , Tx _A , Tx _B (DMA)	
									Rx _A (¹), Rx _B (¹), EXT _A , EXT _B (INT)	

NOTE:

1. Special Receive Condition

Interrupt Vector Mode Table

8085 Modes 8086/88 Mode	V ₄ V ₂	V ₃ V ₁	V ₂ V ₀	Channel	Condition
	0	0	0	B	Tx Buffer Empty Ext/Status Change Rx Char. Available Special Rx Condition (Note 1)
	0	0	1		
	0	1	0		
	0	1	1		
	1	0	0	A	Tx Buffer Empty Ext/Status Change Rx Char. Available Special Rx Condition (Note 1)
	1	0	1		
	1	1	0		
	1	1	1		

NOTE:

1. Special Receive Condition = Parity Error, Rx Overrun Error, Framing Error, End of Frame (SDLC).

2

Write Register 2 (WR2): Channel B

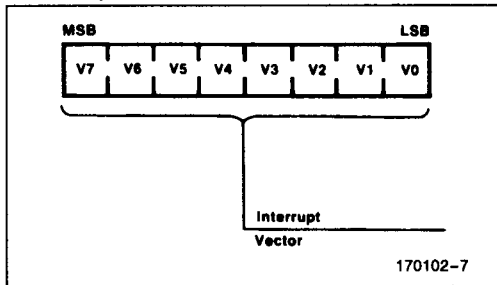

WR2 CHANNEL B

D7-D0

Interrupt vector—This register contains the value of the interrupt vector placed on the data bus during interrupt acknowledge sequences.

Write Register 3 (WR3):

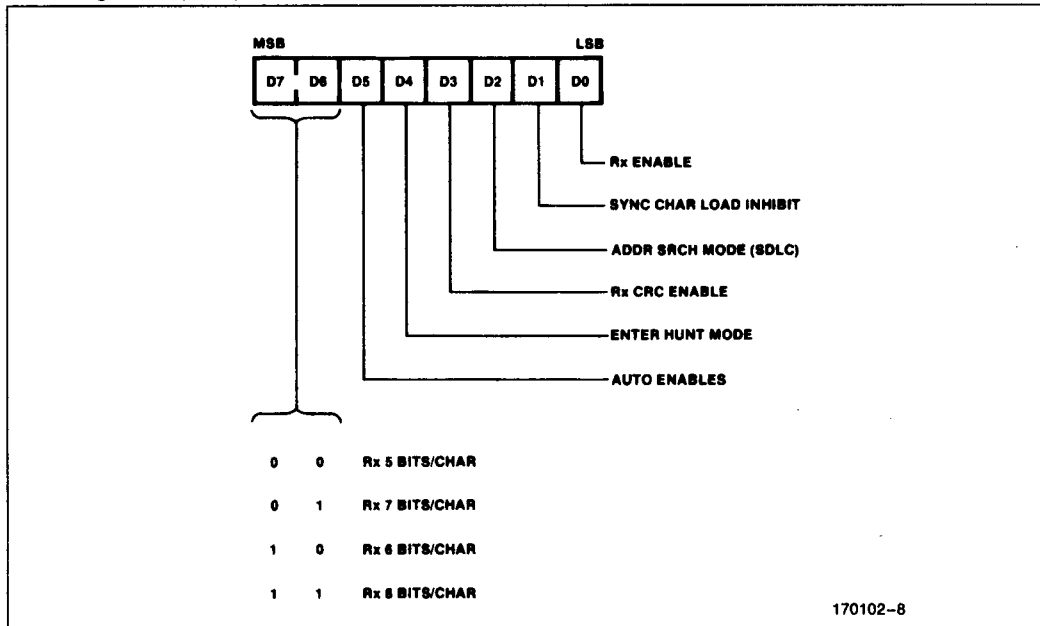

WR3

- D0 Receiver Enable—A one enables the receiver to begin. This bit should be set only after the receiver has been initialized.
- D1 Sync Character Load Inhibit—A one prevents the receiver from loading sync characters into the receive buffers. In SDLC, this bit must be zero.
- D2 Address Search Mode—If the SDLC mode has been selected, the MPSC will receive all frames unless this bit is a 1. If this bit is a 1, the MPSC will receive only frames with address (OFFH) or the value loaded into WR6. This bit must be zero in non-SDLC modes.
- D3 Receive CRC Enable—A one in this bit enables (or re-enables) CRC calculation. CRC calculation starts with the last character placed in the Receiver FIFO. A zero in this bit disables, but does not reset, the Receiver CRC generator.
- D4 Enter Hunt Phase—After initialization, the MPSC automatically enters the Hunt mode. If synchronization is lost, the Hunt phase can be re-entered by writing a one to this bit.
- D5 Auto Enable—A one written to this bit causes \overline{CD} to be automatic enable signal for the receiver and CTS to be an automatic enable signal for the transmitter. A zero written to this bit limits the effect of \overline{CD} and CTS signals to setting/resetting their corresponding bits in the status register (RRO).

D7, D6

- Receive Character length
- 0 0 Receive 5 Data bits/character
- 0 1 Receive 7 Data bits/character
- 1 0 Receive 6 Data bits/character
- 1 1 Receive 8 Data bits/character

WR4

- D0 Parity—A one in this bit causes a parity bit to be added to the programmed number of data bits per character for both the transmitted and received character. If the MPSC is programmed to receive 8 bits per character, the parity bit is not transferred to the microprocessor. With other receiver character lengths, the parity bit is transferred to the microprocessor.

Write Register 4 (WR4):

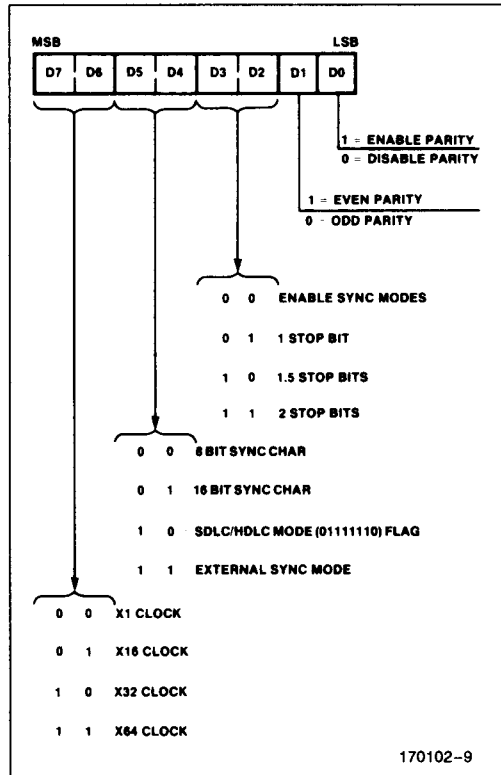

- D1 Even/Odd Parity—If parity is enabled, a one in this bit causes the MPSC to transmit and expect even parity, and a zero causes it to send and expect odd parity.
- D3, D2 Stop bits/sync mode
 - 0 0 Selects synchronous modes
 - 0 1 Async mode, 1 stop bit/character
 - 1 0 Async mode, 1/2 stop bits/character
 - 1 1 Async mode, 2 stop bits/character
- D5, D4 Sync mode select
 - 0 0 8-bit sync character
 - 0 1 16-bit sync character
 - 1 0 SDLC mode (Flag sync)
 - 1 1 External sync mode
- D7, D6 Clock Mode—Selects the clock/data rate multiplier for both the receiver and the transmitter. 1x mode must be selected for synchronous modes. If the 1x mode is selected, bit synchronization must be done externally.

- 0 0 Clock rate = Data rate × 1
- 0 1 Clock rate = Data rate × 16
- 1 0 Clock rate = Data rate × 32
- 1 1 Clock rate = Data rate × 64

Write Register 5 (WR5):

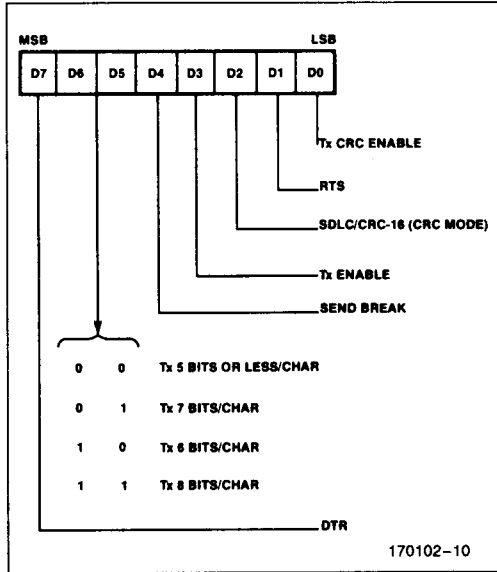

WR5

D0 Transmit CRC Enable—A one in this bit enables the transmitter CRC generator. The CRC calculation is done when a character is moved from the transmit buffer into the shift register. A zero in this bit disables CRC calculations. If this bit is not set when a transmitter underrun occurs, the CRC will not be sent.

- D1** Request to Send—A one in this bit forces the \overline{RTS} pin active (low) and zero in this bit forces the \overline{RTS} pin inactive (high).
- D2** CRC Select—A one in this bit selects the CRC-16 polynomial ($X^{16} + X^{15} + X^2 + 1$) and a zero in this bit selects the CCITT-CRC polynomial ($X^{16} + X^{12} + X^5 + 1$). In SDLC mode, CCITT-CRC must be selected.
- D3** Transmitter Enable—A zero in this bit forces a marking state on the transmitter output. If this bit is set to zero during data or sync character transmission, the marking state is entered after the character has been sent. If this bit is set to zero during transmission of a CRC character, sync or flag bits are substituted for the remainder of the CRC bits.
- D4** Send Break—A one in this bit forces the transmit data low. A zero in this bit allows normal transmitter operation.
- D6, D5** Transmit Character length
 - 0 0 Transmit 1–5 bits/character
 - 0 1 Transmit 7 bits/character
 - 1 0 Transmit 6 bits/character
 - 1 1 Transmit 8 bits/character

Bits to be sent must be right justified least significant bit first, e.g.:

D7 D6 D5 D4 D3 D2 D1 D0
0 0 B5 B4 B3 B2 B1 B0

D7 Data Terminal Ready—When set, this bit forces the \overline{DTR} pin active (low). When reset, this bit forces the \overline{DTR} pin inactive (high).

Five or less mode allows transmission of one to five bits per character. The microprocessor must format the data in the following way:								
D7	D6	D5	D4	D3	D2	D1	D0	
1	1	1	1	0	0	0	B0	Sends one data bit
1	1	1	0	0	0	B1	B0	Sends two data bits
1	1	0	0	0	B2	B1	B0	Sends three data bits
1	0	0	0	B3	B2	B1	B0	Sends four data bits
0	0	0	B4	B3	B2	B1	B0	Sends five data bits



Write Register 6 (WR6):

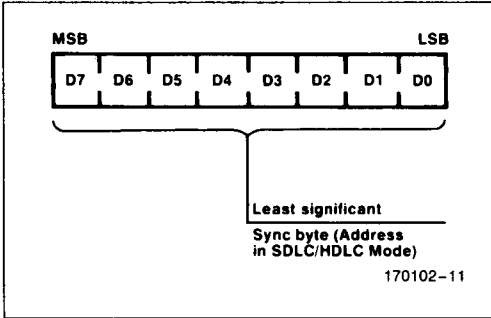

Write Register 7 (WR7):

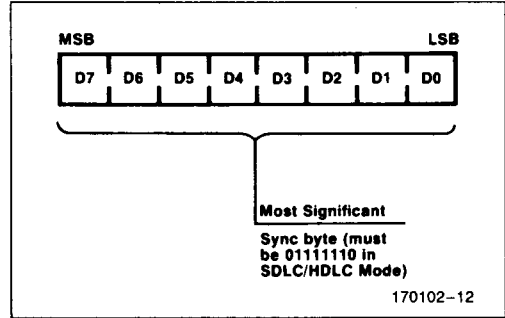

WR6

D7-D0

Sync/Address—This register contains the transmit sync character in Monosync mode, the low order 8 sync bits in Bisync mode, or the Address byte in SDLC mode.

WR7

D7-D0

Sync/Flag—This register contains the receive sync character in Monosync mode, the high order 8 sync bits in Bisync mode, or the Flag character (01111110) in SDLC mode. WR7 is not used in External Sync mode.

RR0

D0

Receive Character Available—This bit is set when the receive FIFO contains data and is reset when the FIFO is empty.

D1

Interrupt In-Service*—If an Internal Interrupt is pending, this bit is set at the falling edge of the second \overline{INTA} pulse of an \overline{INTA} cycle. In non-vector mode, this bit is set at the falling edge of \overline{RD} after pointer 2 is specified. This bit is reset when an EOI command is issued and there are no other interrupts in-service at that time.

D2

Transmit Buffer Empty—This bit is set whenever the transmit buffer is

*This bit is only valid when $\overline{IP1}$ is active low and is always zero in Channel B.

Read Register 0 (RR0):

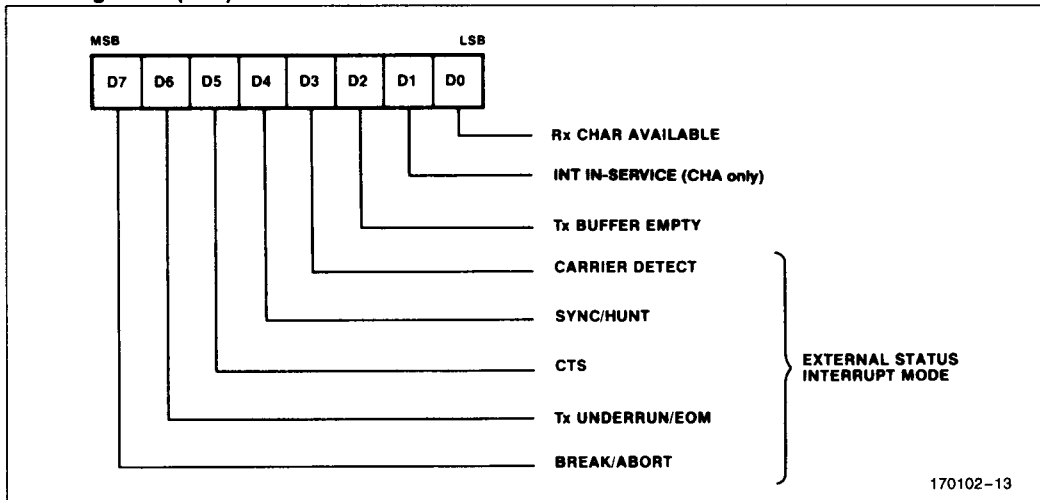

empty except when CRC characters are being sent in a synchronous mode. This bit is reset when the transmit buffer is loaded. This bit is set after an MPSC reset.

D3 Carrier Detect—This bit contains the state of the \overline{CD} pin at the time of the last change of any of the External/Status bits (CD, CTS, Sync/Hunt, Break/Abort, or Tx Underrun/EOM). Any change of state of the \overline{CD} pin causes the CD bit to be latched and causes an External/Status interrupt. This bit indicates current state of the \overline{CD} pin immediately following a Reset External/Status Interrupt command.

D4 Sync/Hunt—In asynchronous modes, the operation of this bit is similar to the CD status bit, except that Sync/Hunt shows the state of the \overline{SYNDET} input. Any High-to-Low transition on the \overline{SYNDET} pin sets this bit, and causes an External/Status interrupt (if enabled). The Reset External/Status Interrupt command is issued to clear the interrupt. A Low-to-High transition clears this bit and sets the External/Status interrupt. When the External/Status interrupt is set by the change in state of any other input or condition, this bit shows the inverted state of the \overline{SYNDET} pin at time of the change. This bit must be read immediately following a Reset External/Status Interrupt command to read the current state of the \overline{SYNDET} input.

In the External Sync mode, the Sync/Hunt bit operates in a fashion similar to the Asynchronous mode, except the Enter Hunt Mode control bit enables the external sync detection logic. When the External Sync Mode and Enter Hunt Mode bits are set (for example, when the receiver is enabled following a reset), the \overline{SYNDET} input must be held High by the external logic until external character synchronization is achieved. A High at the \overline{SYNDET} input holds the Sync/Hunt status in the reset condition.

When external synchronization is achieved, \overline{SYNDET} must be driven Low on the second rising edge of \overline{RxC} after the rising edge of \overline{RxC} on which the last bit of the sync character was received. In other words, af-

ter the sync pattern is detected, the external logic must wait for two full Receive Clock cycles to activate the \overline{SYNDET} input. Once \overline{SYNDET} is forced Low, it is good practice to keep it Low until the CPU informs the external sync logic that synchronization has been lost or a new message is about to start. The High-to-Low transition of the \overline{SYNDET} output sets the Sync/Hunt bit, which sets the External/Status interrupt. The CPU must clear the interrupt by issuing the Reset External/Status Interrupt Command.

When the \overline{SYNDET} input goes High again, another External/Status interrupt is generated that must also be cleared. The Enter Hunt Mode control bit is set whenever character synchronization is lost or the end of message is detected. In this case, the MPSC again looks for a High-to-Low transition on the \overline{SYNDET} input and the operation repeats as explained previously. This implies the CPU should also inform the external logic that character synchronization has been lost and that the MPSC is waiting for \overline{SYNDET} to become active.

In the Monosync and Bisync Receive modes, the Sync/Hunt status bit is initially set to 1 by the Enter Hunt Mode bit. The Sync/Hunt bit is reset when the MPSC establishes character synchronization. The High-to-Low transition of the Sync/Hunt bit causes an External/Status interrupt that must be cleared by the CPU issuing the Reset External/Status Interrupt command. This enables the MPSC to detect the next transition of other External/Status bits.

When the CPU detects the end of message or that character synchronization is lost, it sets the Enter Hunt Mode control bit, which sets the Sync/Hunt bit to 1. The Low-to-High transition of the Sync/Hunt bit sets the External/Status Interrupt, which must also be cleared by the Reset External/Status Interrupt Command. Note that the \overline{SYNDET} pin acts as an output in this mode, and goes low every time a sync pattern is detected in the data stream.

- In the SDLC mode, the Sync/Hunt bit is initially set by the Enter Hunt mode bit, or when the receiver is disabled. In any case, it is reset to 0 when the opening flag of the first frame is detected by the MPSC. The External/Status interrupt is also generated, and should be handled as discussed previously.
- Unlike the Monosync and Bisync modes, once the Sync/Hunt bit is reset in the SDLC mode, it does not need to be set when the end of message is detected. The MPSC automatically maintains synchronization. The only way the Sync/Hunt bit can be set again is by the Enter Hunt Mode bit, or by disabling the receiver.
- D5** Clear to Send—This bit contains the inverted state of the $\overline{\text{CTS}}$ pin at the time of the last change of any of the External/Status bits (CD, CTS, Sync/Hunt, Break/Abort, or Tx Underrun/EOM). Any change of state of the $\overline{\text{CTS}}$ pin causes the CTS bit to be latched and causes an External/Status interrupt. This bit indicates the inverse of the current state of the $\overline{\text{CTS}}$ pin immediately following a Reset External/Status Interrupt command.
- D6** Transmitter Underrun/End of Message—This bit is in a set condition following a reset (internal or external). The only command that can reset this bit is the Reset Transmit Underrun/EOM Latch command (WR0, D₆ and D₇). When the Transmit Underrun condition occurs, this bit is set, which causes the External/Status Interrupt which must be reset by issuing a Reset External/Status command (WR0; command 2).
- D7** Break/Abort—In the Asynchronous Receive mode, this bit is set when a Break sequence (null character plus framing error) is detected in the data stream. The External/Status interrupt, if enabled, is set when break is detected. The interrupt service routine must issue the Reset External/Status Interrupt command (WR0, Command 2) to the break detection logic so the Break sequence termination can be recognized.
- The Break/Abort bit is reset when the termination of the Break sequence is detected in the incoming data stream. The termination of the Break sequence also causes the External/Status interrupt to be set. The Reset External/Status Interrupt command must be issued to enable the break detection logic to look for the next Break sequence. A single extraneous null character is present in the receiver after the termination of a break; it should be read and discarded.
- In the SDLC Receive mode, this status bit is set by the detection of an Abort sequence (seven or more 1's). The External/Status interrupt is handled the same way as in the case of a Break. The Break/Abort bit is not used in the Synchronous Receive mode.
- D0** All Sent—This bit is set when all characters have been sent, in asynchronous modes. It is reset when characters are in the transmitter, in asynchronous modes. In synchronous modes, this bit is always set.
- RR1:**
D3, D2, D1 Residue Codes—Bit synchronous protocols allow I-fields that are not an integral number of characters. Since transfers from the MPSC to the CPU are character oriented, the residue codes provide the capability of receiving leftover bits. Residue bits are right justified in the last data byte received or first CRC byte.
- D4** Parity Error—If parity is enabled, this bit is set for received characters whose parity does not match the programmed sense (Even/Odd). This bit is latched. Once an error occurs, it remains set until the Error Reset command is written.
- D5** Receive Overrun Error—This bit indicates that the receive FIFO has been overloaded by the receiver. The last character in the FIFO is overwritten and flagged with this error. Once the overwritten character is read, this error condition is latched until reset by the Error Reset command. If the MPSC is in the status affects vector mode, the overrun causes a special Receive Condition Vector.
- D6** CRC/Framing Error—In async modes, a one in this bit indicates a receive framing error. In synchronous modes, a one in this bit indicates that the calculated CRC value does not match the last two bytes received. It can be reset by issuing an Error Reset command.

SDLC Residue Code Table (1 Field Bits in 2 Previous Bytes)

RR1			8 bits/char		7 bits/char		6 bits/char		5 bits/char	
D3	D2	D1	First CRC Byte	Last Data Byte	First CRC Byte	Last Data Byte	First CRC Byte	Last Data Byte	First CRC Byte	Last Data Byte
1	0	0	0	3	0	2	0	1	0	5
0	1	0	0	4	0	3	0	2	0	1
1	1	0	0	5	0	4	0	3	0	2
0	0	1	0	6	0	5	0	4	0	3
1	0	1	0	7	0	6	0	5	—	—
0	1	1	0	8	0	—	—	—	—	—
1	1	1	1	8	—	—	—	—	—	—
0	0	0	2	8	1	7	0	6	0	4

2

Read Register 1 (RR1): (Special Receive Condition Mode)

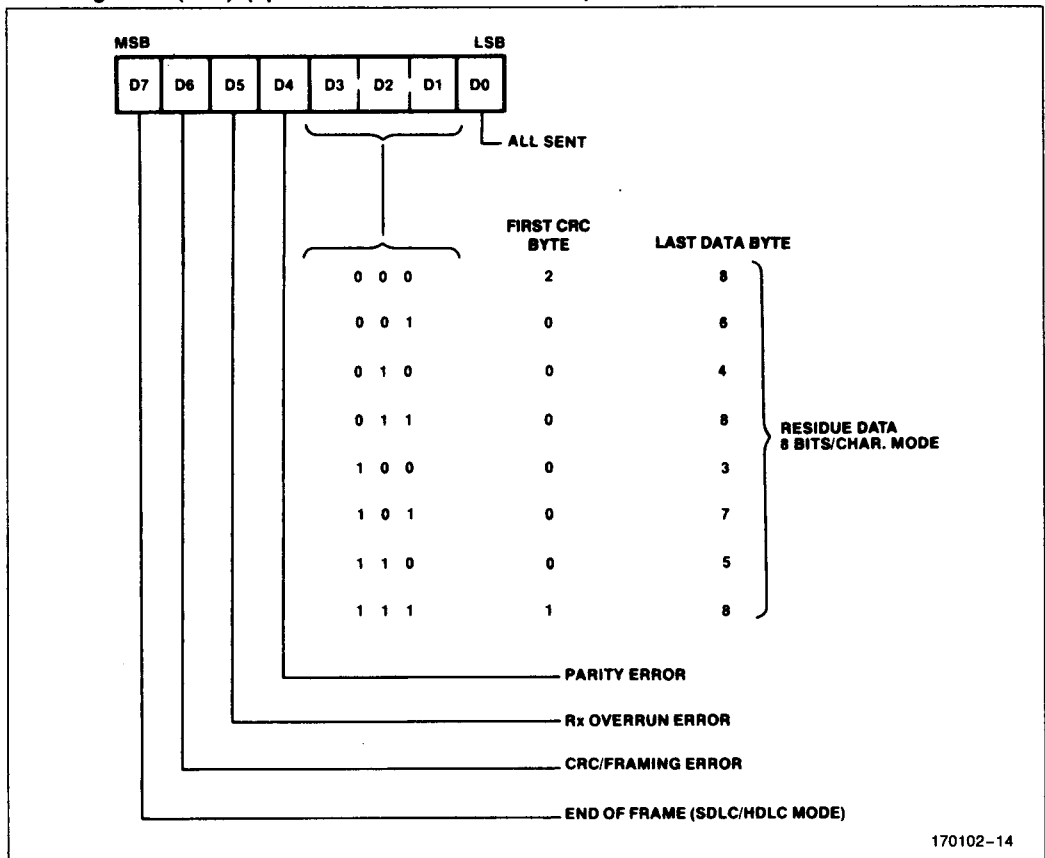

D7 End of Frame—This bit is valid only in SDLC mode. A one indicates that a valid ending flag has been received. This bit is reset either by an Error Reset command or upon reception of the first character of the next frame.

Read Register 2 (RR2):

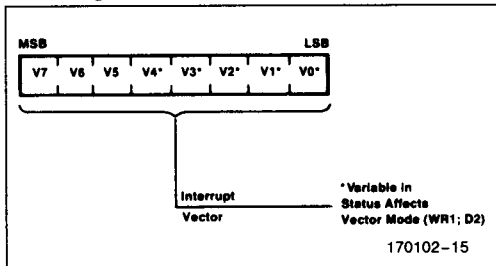

RR2 Channel B

D7-D0 Interrupt Vector—Contains the interrupt vector programmed into WR2. If the status affects vector mode is selected (WR1; D2), it contains the modified vector (See WR2). RR2 contains the modified vector for the highest priority interrupt pending. If no interrupts are pending, the variable bits in the vector are set to one.

SYSTEM INTERFACE

General

The MPSC to Microprocessor System interface can be configured in many flexible ways. The basic interface types are polled, wait, interrupt driven, or direct memory access driven.

Polled operation is accomplished by repetitively reading the status of the MPSC, and making decisions based on that status. The MPSC can be polled at any time.

Wait operation allows slightly faster data throughput for the MPSC by manipulating the Ready input to the microprocessor. Block Read or Write Operations to the MPSC are started at will by the microprocessor and the MPSC deactivates its RDY signal if it is not yet ready to transmit the new byte, or if reception of new byte is not completed.

Interrupt driven operation is accomplished via an internal or external interrupt controller. When the MPSC requires service, it sends an interrupt request signal to the microprocessor, which responds with

an interrupt acknowledge signal. When the internal or external interrupt controller receives the acknowledge, it vectors the microprocessor to a service routine, in which the transaction occurs.

DMA operation is accomplished via an external DMA controller. When the MPSC needs a data transfer, it requests a DMA cycle from the DMA controller. The DMA controller then takes control of the bus and simultaneously does a read from the MPSC and a write to memory or vice-versa.

The following section describes the many configurations of these basic types of system interface techniques for both serial channels.

POLLED OPERATION

In the polled mode, the CPU must monitor the desired conditions within the read registers. All data available, status, and error conditions are represented by the appropriate bits in read registers 0 and 1 for channels A and B.

There are two ways in which the software task of monitoring the status of the MPSC has been reduced. One is the "ORing" of all conditions into the Interrupt Pending bit. (RR0; D1 channel A only). This bit is set when the MPSC requires service, allowing the CPU to monitor one bit instead of four status registers. The other is available when the "status-affects-vector" mode is selected. By reading RR2 Channel B, the CPU can read a vector whose value will indicate that one or more of group of conditions has occurred, narrowing the field of possible conditions. See WR2 and RR2 in the Detailed Command Description section.

WAIT OPERATION

Wait Operation is intended to facilitate data transmission or reception using block move operations. If a block of data is to be transmitted, for example, the CPU can execute a String I/O instruction to the MPSC. After writing the first byte, the CPU will attempt to write a second byte immediately as is the case of block move. The MPSC forces the RDY signal low which inserts wait states in the CPU's write cycle until the transmit buffer is ready to accept a new byte. At that time, the RDY signal is high allowing the CPU to finish the write cycle. The CPU then attempts the third write and the process is repeated.

Similar operation can be programmed for the receiver. During initialization, wait on transmit (WR1; D5 = 0)

Software Flow, Polled Operation

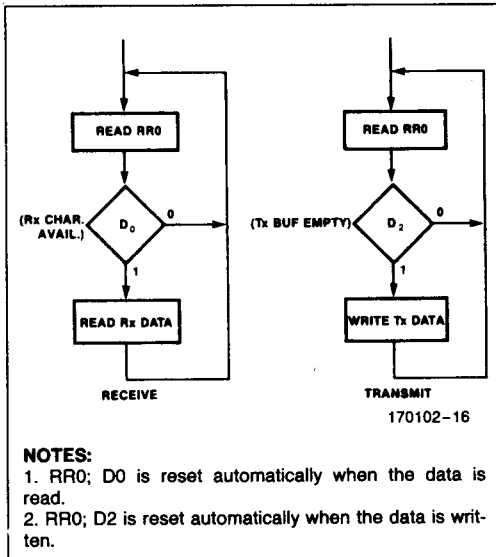

or wait on receive (WR1; D5 = 1) can be selected. The wait operation can be enabled/disabled by setting/resetting the Wait Enable Bit (WR1; D7).

NOTE:

CAUTION: ANY CONDITION THAT CAN CAUSE THE TRANSMITTER TO STOP (E.G., CTS GOES INACTIVE) OR THE RECEIVER TO STOP (E.G., RX DATA STOPS) WILL CAUSE THE MPSC TO HANG THE CPU UP IN WAIT STATES UNTIL RESET. EXTREME CARE SHOULD BE TAKEN WHEN USING THIS FEATURE.

INTERRUPT DRIVEN OPERATION

The MPSC can be programmed into several interrupt modes: Non-Vectored, 8085 vectored, and 8088/86 vectored. In both vectored modes, multiple MPSC's can be daisy-chained.

In the vectored mode, the MPSC responds to an interrupt acknowledge sequence by placing a call instruction (8085 mode) and interrupt vector (8085 and 8088/86 mode) on the data bus.

The MPSC can be programmed to cause an interrupt due to up to 14 conditions in each channel. The status of these interrupt conditions is contained in Read Registers 0 and 1. These 14 conditions are all directed to cause 3 different types of internal interrupt request for each channel: receive/interrupts, transmit interrupts and external/status interrupts (if enabled).

This results in up to 6 internal interrupt request signals. The priority of those signals can be programmed to one of two fixed modes:

Highest Priority Lowest Priority

RxA RxB TxA TxB ExTA ExTB

RxA TxA RxB TxB ExTA ExTB

The interrupt priority resolution works differently for vectored and non-vectored modes.



Hardware Configuration, Polled Operation

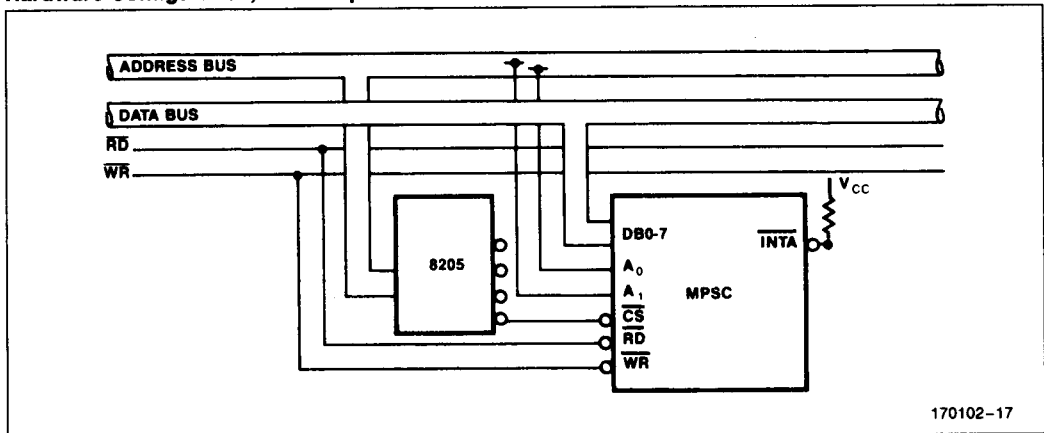

Interrupt Condition Grouping

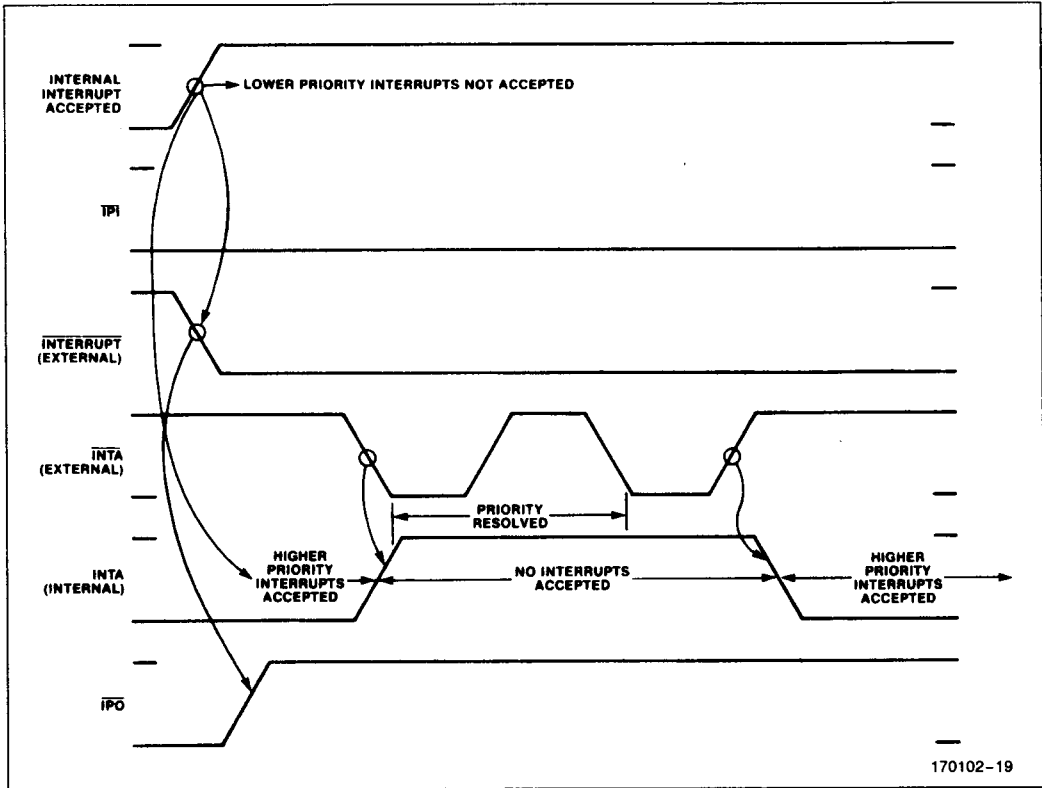
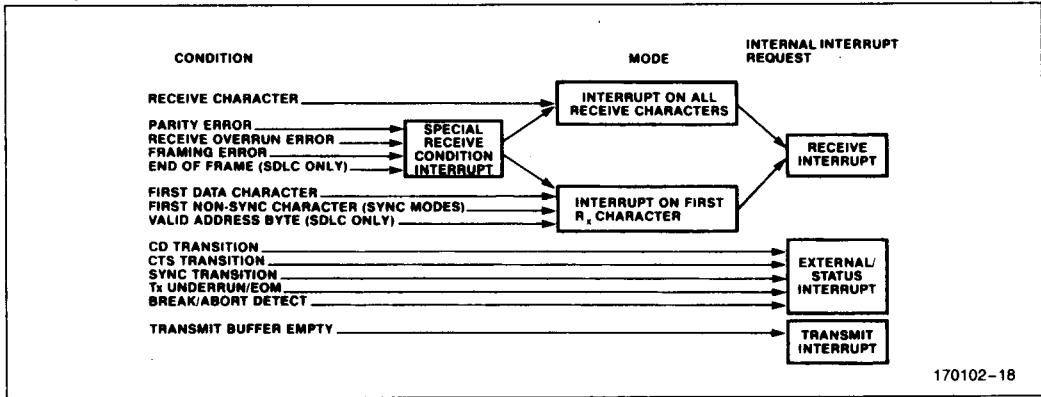

PRIORITY RESOLUTION: VECTORED MODE

Any interrupt condition can be accepted internally to the MPSC at any time, unless the MPSC's internal INTA signal is active, unless a higher priority interrupt is currently accepted, or if IPI is inactive (high). The MPSC's internal INTA is set on the leading (fall-

ing) edge of the first External \overline{INTA} pulse and reset on the trailing (rising) edge of the second External \overline{INTA} pulse. After an interrupt is accepted internally, and External \overline{INT} request is generated and the IPO goes inactive. IPO and IPI are used for daisy-chaining MPSC's together.

In-Service Timing

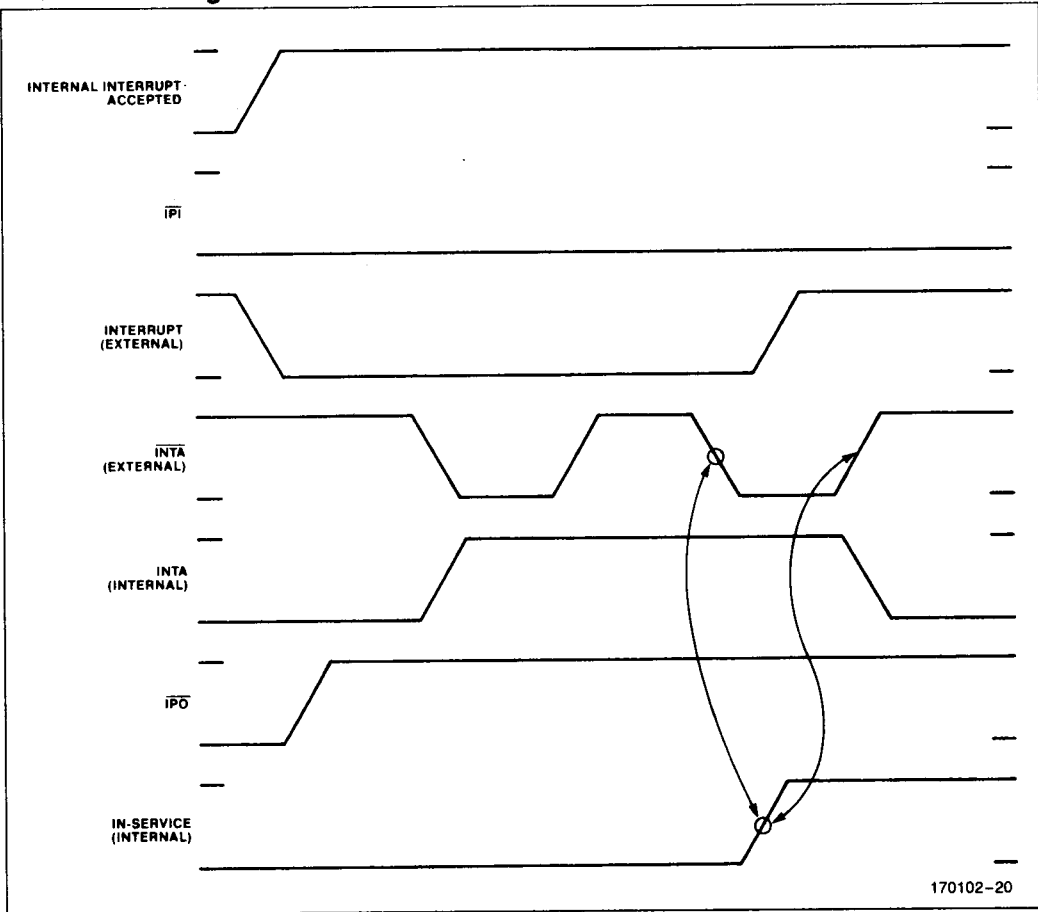

2

The MPSC's internal \overline{INTA} is set on the leading (falling) edge of the first external \overline{INTA} pulse, and reset on the trailing (rising) edge of the second external \overline{INTA} pulse. After an interrupt is accepted internally, and external \overline{INT} request is generated and \overline{IPO} goes inactive (high). \overline{IPO} and \overline{IPI} are used for daisy-chaining MPSC's together.

Each of the six interrupt sources has an associated In-Service latch. After priority has been resolved, the highest priority In-Service latch is set. After the In-Service latch is set, the \overline{INT} pin goes inactive (high).

NOTE:

If the External \overline{INT} pin is active and the \overline{IPI} signal is pulled inactive high, the \overline{INT} signal will also go inactive. \overline{IPI} qualifies the External \overline{INT} Signal.

EOI Command Timing

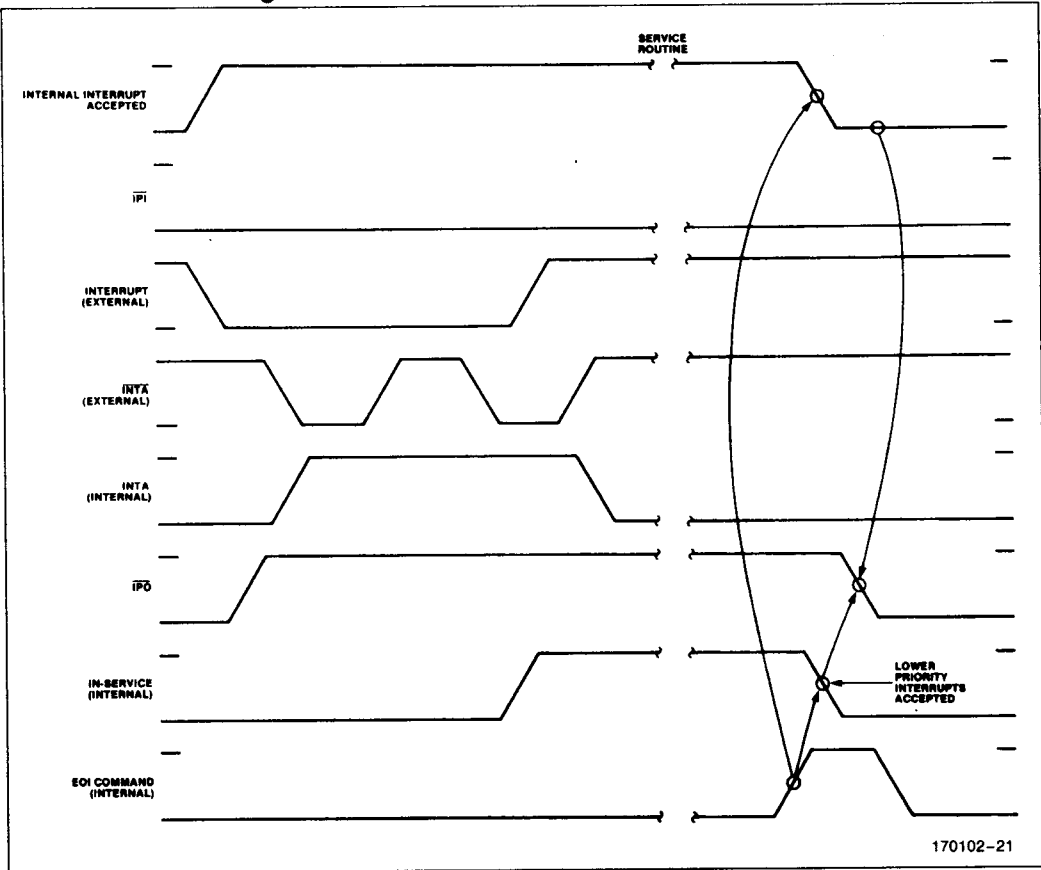

Lower priority interrupts are not accepted internally while the In-Service latch is set. However, higher priority interrupts are accepted internally and a new external \overline{INT} request is generated. If the CPU responds with a new \overline{INTA} sequence, the MPSC will respond as before, suspending the lower priority interrupt.

After the interrupt is serviced, the End-of-Interrupt (EOI) command should be written to the MPSC. This command will cause an internal pulse that is used to reset the In-Service Latch which allows service for lower priority interrupts in the daisy-chain to resume, provided a new \overline{INTA} sequence does not start for a higher priority interrupt (higher than the highest under service). If there is no interrupt pending internally, the \overline{IPO} follows \overline{IPI} .

Non-Vectored Interrupt Timing

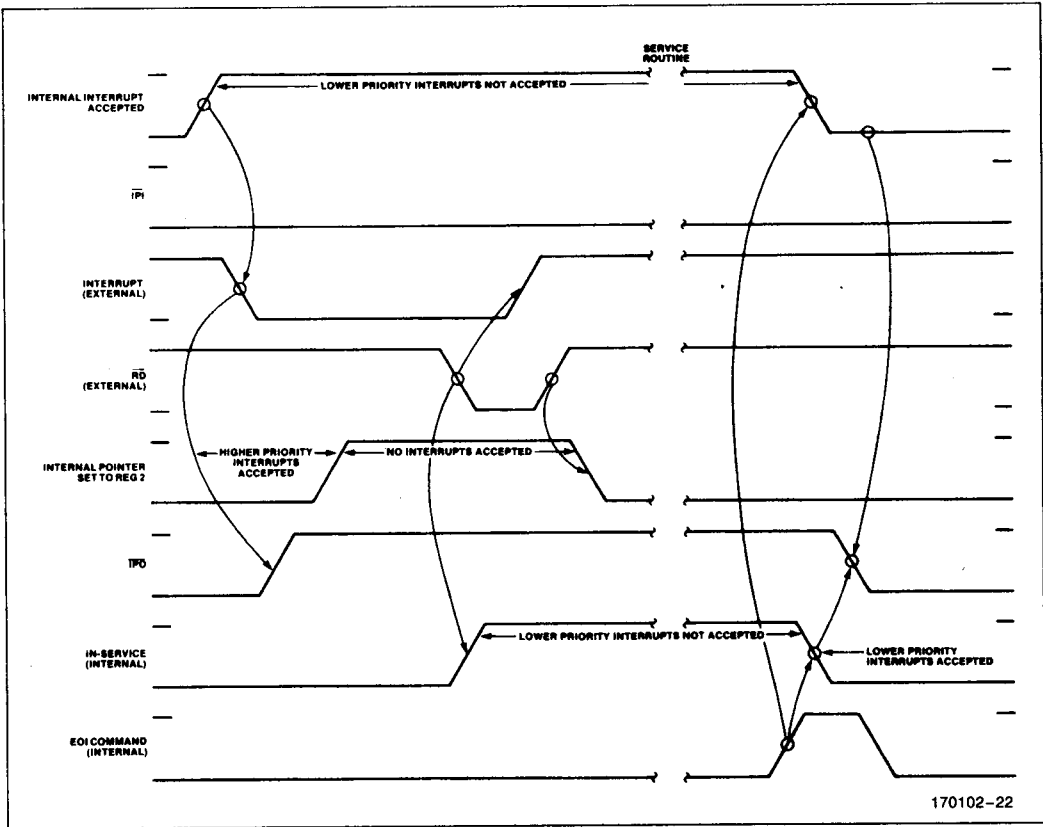

2

170102-22

**PRIORITY RESOLUTION:
NON-VECTORED MODE**

In non-vector mode, the MPSC does not respond to interrupt acknowledge sequences. The \overline{INTA} input (pin 27) must be pulled high for proper operation. The MPSC should be programmed to the Status-Affects-Vector mode, and the CPU should read RR2 (Ch. B) in its service routine to determine which interrupt requires service.

In this case, the internal pointer being set to RR2 provides the same function as the internal INTA sig-

nal in the vectored mode. It inhibits acceptance of any additional internal interrupts and its leading edge starts the interrupt priority resolution circuit. The interrupt priority resolution is ended by the leading edge of the read signal used by the CPU to retrieve the modified vector. The leading edge of read sets the In-Service latch and forces the external \overline{INT} output inactive (high). The internal pointer is reset to zero after the trailing edge of the read pulse.

NOTE:

That if RR2 is specified but not read, no internal interrupts, regardless of priority, are accepted.

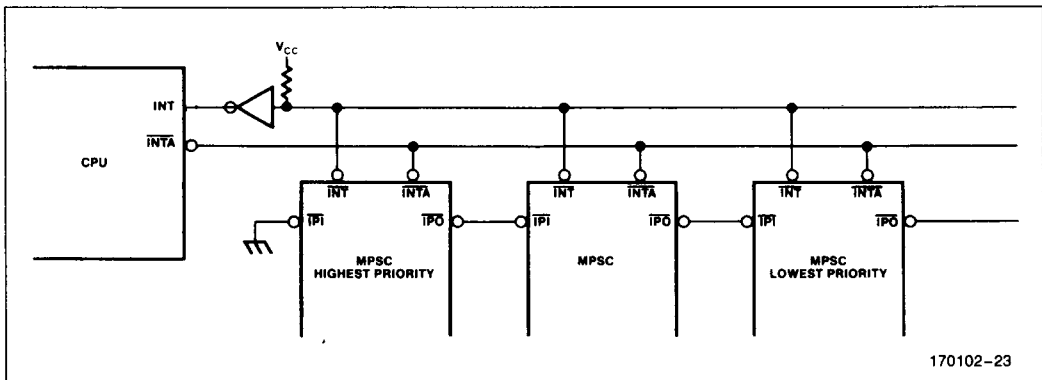

DAISY CHAINING MPSC

In the vectored interrupt mode, multiple MPSC's can be daisy-chained on the same \overline{INT} , \overline{INTA} signals. These signals, in conjunction with the \overline{IPI} and \overline{IPO} allow a daisy-chain-like interrupt resolution scheme. This scheme can be configured for either 8085 or 8086/88 based system.

In either mode, the same hardware configuration is called for. The \overline{INT} request lines are wire-OR'ed together at the input of a TTL inverter which drives the \overline{INT} pin of the CPU. The \overline{INTA} signal from the CPU drives all of the daisy-chained MPSC's.

The MPSC drives \overline{IPO} (Interrupt Priority Output) inactive (high) if \overline{IPI} (Interrupt Priority Input) is inactive (high), or if the MPSC has an interrupt pending.

The \overline{IPO} of the highest priority MPSC is connected to the \overline{IPI} of the next highest priority MPSC, and so on.

If \overline{IPI} is active (low), the MPSC knows that all higher priority MPSC's have no interrupts pending. The \overline{IPI} pin of the highest priority MPSC is strapped active (low) to ensure that it always has priority over the rest.

MPSC's Daisy-chained on an 8088/86 CPU should be programmed to the 8088/86 Interrupt mode (WR2; D4, D3 Ch. A). MPSC's Daisy-chained on an 8085 CPU should be programmed to 8085 interrupt mode 1 if it is the highest priority MPSC. In this mode, the highest priority MPSC issues the CALL instruction during the first \overline{INTA} cycle, and the interrupting MPSC provides the interrupt vector during the following \overline{INTA} cycles. Lower priority MPSC's should be programmed to 8085 interrupt mode 2.

MPSC's used alone in 8085 systems should be programmed to 8085 mode 1 interrupt operation.

DMA Acknowledge Circuit

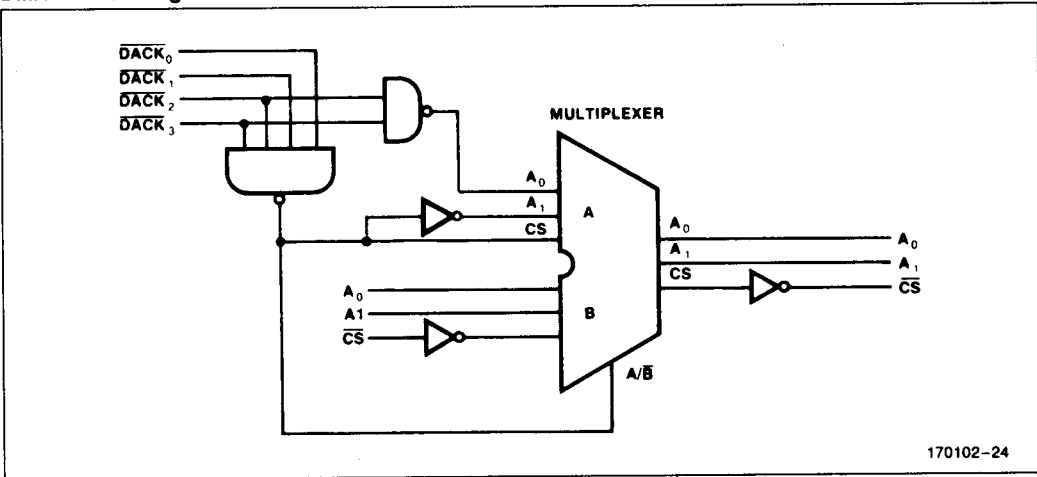

170102-24

2

DMA Timing

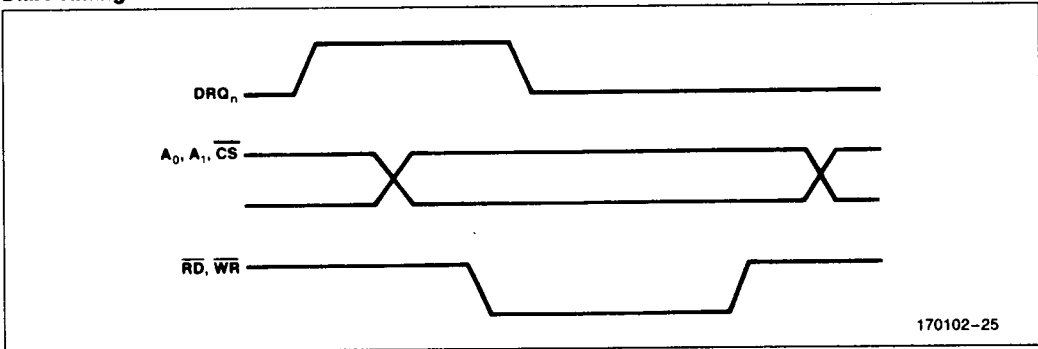

170102-25

DMA OPERATION

Each MPSC can be programmed to utilize up to four DMA channels: Transmit Channel A, Receive Channel A, Transmit Channel B, Receive Channel B. Each DMA Channel has an associated DMA Request line. Acknowledgement of a DMA cycle is done via normal data read or write cycles. This is accomplished by encoding the DACK signals to generate A_0 , A_1 , and \overline{CS} , and multiplexing them with the normal A_0 , A_1 , and \overline{CS} signals.

PERMUTATIONS

Channels A and B can be used with different system interface modes. In all cases it is possible to poll the MPSC. The following table shows the possible per-

mutations of interrupt, wait, and DMA modes for channels A and B. Bits D_1 , D_0 of WR2 Ch. A determine these permutations.

Permutation WR2 Ch. A		Channel A	Channel B
D_1	D_0		
0	0	Wait Interrupt Polled	Wait Interrupt Polled
0	1	DMA Polled	Interrupt Polled
1	0	DMA Polled	DMA Polled

NOTE:
 $D_1, D_0 = 1, 1$ is illegal.

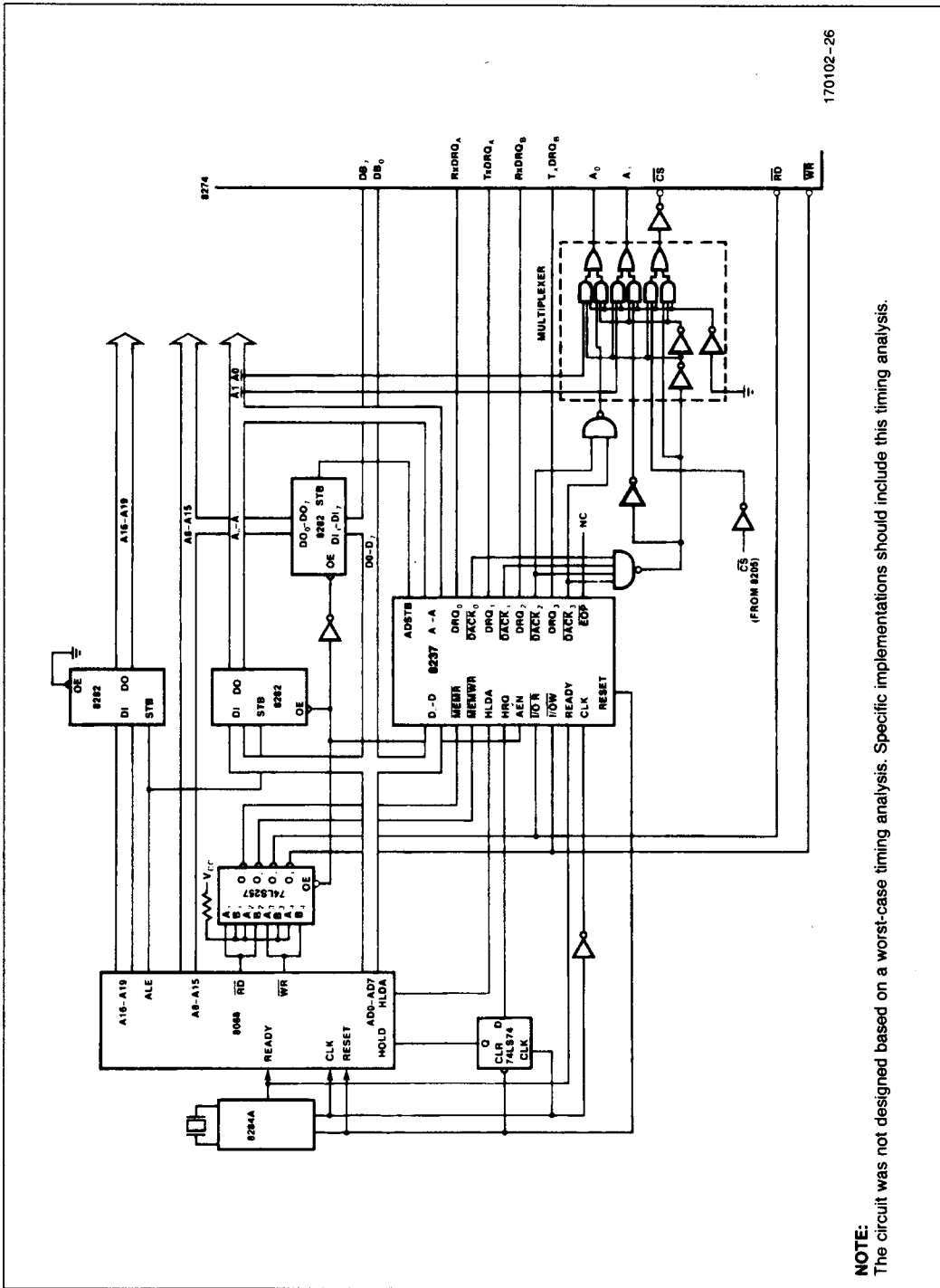

NOTE: The circuit was not designed based on a worst-case timing analysis. Specific implementations should include this timing analysis.

PROGRAMMING HINTS

This section will describe some useful programming hints which may be useful in program development.

Asynchronous Operation

At the end of transmission, the CPU must issue "Reset Transmit Interrupt/DMA Pending" command in WR0 to reset the last transmit empty request which was not satisfied. Failing to do so will result in the MPSC locking up in a transmit empty state forever.

Non-Vectored Mode

In non-vectored mode, the Interrupt Acknowledge pin (INTA) on the MPSC must be tied high through a pull-up resistor. Failing to do so will result in unpredictable response from the 8274.

HDLC/SDLC Mode

When receiving data in SDLC mode, the CRC bytes must be read by the CPU (or DMA controller) just like any other data field. Failing to do so will result in receiver buffer overflow. The CRC bytes are not to be used for CRC verification. Residue bits may be contained in the first CRC byte. Also, the End of Frame Interrupt indicates that the entire frame has been received. At this point, the CRC result (RR1: D6) and residue code (RR1; D3, D2, D1) may be checked.

Status Register RR2

RR2 contains the vector which gets modified to indicate the source of interrupt (See the section titled MPSC Modes of Operation). However, the state of the vector does not change if no new interrupts are generated. The contents of RR2 are only changed when a new interrupt is generated. In order to get the correct information, RR2 must be read only after an interrupt is generated, otherwise it will indicate the previous state.

Initialization Sequence

The MPSC initialization routine must issue a channel Reset Command at the beginning. WR4 should be defined before other registers. At the end of the initialization sequence, Reset External/Status and Error Reset commands should be issued to clear any spurious interrupts which may have been caused at power up.

Transmit Under-run/EOM Latch

In SDLC/HDLC, bisync and monosync mode, the transmit under-run/EOM must be reset to enable the CRC check bytes to be appended to the transmit frame or transmit message. The transmit under-run/EOM latch can be reset only after the first character is loaded into the transmit buffer. When the transmitter under-runs at the end of the frame, CRC check bytes are appended to the frame/message. The transmit under-run/EOM latch can be reset at any time during the transmission after the first character. However, it should be reset *before* the transmitter under-runs otherwise, both bytes of the CRC may not be appended to the frame/message. In the receive mode in bisync operation, the CPU must read the CRC bytes and two more SYNC characters before checking for valid CRC result in RR1.

Sync Character Load Inhibit

In bisync/monosync mode only, it is possible to prevent loading sync characters into the receive buffers by setting the sync character load inhibit bit (WR3; D1 = 1). Caution must be exercised in using this option. It may be possible to get a CRC character in the received message which may match the sync character and not get transferred to the receive buffer. However, sync character load inhibit should be enabled during all pre-frame sync characters so the software routine does not have to read them from the MPSC.

In SDLC/HDLC mode, sync character load inhibit bit must be reset to zero for proper operation.

EOI Command

EOI command can only be issued through channel A irrespective of which channel had generated the interrupt.

Priority in DMA Mode

There is no priority in DMA mode between the following four signals: TxDRQ(CHA), RxDRQ(CHA), TxDRQ(CHB), RxDRQ(CHB). The priority between these four signals must be resolved by the DMA controller. At any given time, all four DMA channels from the 8274 are capable of going active.

ABSOLUTE MAXIMUM RATINGS*

Ambient Temperature
 Under Bias 0°C to + 70°C

Storage Temperature
 (Ceramic Package) - 65°C to + 150°C
 (Plastic Package) - 40°C to + 125°C

Voltage on Any Pin with
 Respect to Ground - 0.5V to + 7.0V

NOTICE: This is a production data sheet. The specifications are subject to change without notice.

**WARNING: Stressing the device beyond the "Absolute Maximum Ratings" may cause permanent damage. These are stress ratings only. Operation beyond the "Operating Conditions" is not recommended and extended exposure beyond the "Operating Conditions" may affect device reliability.*

D.C. CHARACTERISTICS $T_A = 0^\circ\text{C to } +70^\circ\text{C}; V_{CC} = +5\text{V } \pm 10\%$

Symbol	Parameter	Min	Max	Units	Test Conditions
V _{IL}	Input Low Voltage	-0.5	+0.8	V	
V _{IH}	Input High Voltage	+2.0	V _{CC} + 0.5	V	
V _{OL}	Output Low Voltage		+0.45	V	I _{OL} = 2.0 mA
V _{OH}	Output High Voltage	+2.4		V	I _{OH} = 200 μA
I _{IL}	Input Leakage Current		± 10	μA	V _{IN} = V _{CC} to 0V
I _{OFL}	Output Leakage Current		± 10	μA	V _{OUT} = V _{CC} to 0.45V
I _{CC}	V _{CC} Supply Current		200	mA	

NOTE:

1. For Extended Temperature EXPRESS, use MIL8274 electrical Parameters.

CAPACITANCE $T_A = 25^\circ\text{C}; V_{CC} = \text{GND} = 0\text{V}$

Symbol	Parameter	Min	Max	Units	Test Conditions
C _{IN}	Input Capacitance		10	pF	f _c = 1 MHz
C _{OUT}	Output Capacitance		15	pF	Unmeasured pins returned to GND
C _{I/O}	Input/Output Capacitance		20	pF	

A.C. CHARACTERISTICS $T_A = 0^\circ\text{C}$ to $+70^\circ\text{C}$; $V_{CC} = +5V \pm 10\%$

Symbol	Parameter	Min	Max	Units	Test Conditions
t_{CY}	CLK Period	250	4000	ns	
t_{CL}	CLK Low Time	105	2000	ns	
t_{CH}	CLK High Time	105	2000	ns	
t_r	CLK Rise Time	0	30	ns	
t_f	CLK Fall Time	0	30	ns	
t_{AR}	A0, A1 Setup to $\overline{RD} \downarrow$	0		ns	
t_{AD}	A0, A1 to Data Output Delay		200	ns	$C_L = 150 \text{ pF}$
t_{RA}	A0, A1 Hold after $\overline{RD} \uparrow$	0		ns	
t_{RD}	$\overline{RD} \downarrow$ to Data Output Delay		200	ns	$C_L = 150 \text{ pF}$
t_{RR}	\overline{RD} Pulse Width	250		ns	
t_{DF}	Output Float Delay		120	ns	
t_{AW}	\overline{CS} , A0, A1 Setup to $\overline{WR} \downarrow$	0		ns	
t_{WA}	\overline{CS} , A0, A1 Hold after $\overline{WR} \uparrow$	0		ns	
t_{WW}	\overline{WR} Pulse Width	250		ns	
t_{DW}	Data Setup to $\overline{WR} \uparrow$	150		ns	
t_{WD}	Data Hold after $\overline{WR} \uparrow$	0		ns	
t_{PI}	\overline{IPI} Setup to $\overline{INTA} \downarrow$	0		ns	
t_{IP}	\overline{IPI} Hold after $\overline{INTA} \uparrow$	10		ns	
t_{II}	\overline{INTA} Pulse Width	250		ns	
t_{PIPO}	$\overline{IPI} \downarrow$ to \overline{IPO} Delay		100	ns	
t_{ID}	$\overline{INTA} \downarrow$ to Data Output Delay		200	ns	
t_{CQ}	\overline{RD} or \overline{WR} to $\overline{DRQ} \downarrow$		150	ns	
t_{RV}	Recovery Time Between Controls	300		ns	
t_{CW}	\overline{CS} , A0, A1 to \overline{RDY}_A or \overline{RDY}_B Delay		140	ns	
t_{DCY}	Data Clock Cycle	4.5		tcy	
t_{DCL}	Data Clock Low Time	180		ns	
t_{DCH}	Data Clock High Time	180		ns	
t_{TD}	\overline{TxC} to \overline{TxD} Delay (x1 Mode)		300	ns	
t_{DS}	RxD Setup to $\overline{RxC} \uparrow$	0		ns	
t_{DH}	RxD Hold after $\overline{RxC} \uparrow$	140		ns	
t_{TD}	\overline{TxC} to \overline{INT} Delay	4	6	tcy	
t_{IRD}	RxC to \overline{INT} Delay	7	10	tcy	
t_{PL}	\overline{CTS} , \overline{CD} , \overline{SYNDET} Low Time	200		ns	
t_{PH}	\overline{CTS} , \overline{CD} , \overline{SYNDET} High Time	200		ns	
t_{IPD}	External \overline{INT} from \overline{CTS} , \overline{CD} , \overline{SYNDET}		500	ns	

2

A.C. TESTING INPUT/OUTPUT WAVEFORM

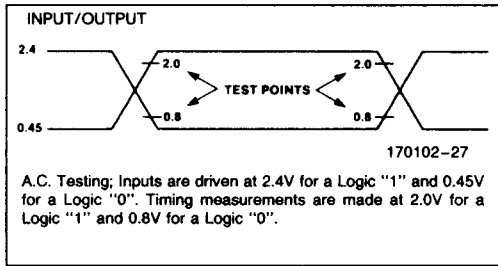

A.C. TESTING LOAD CIRCUIT

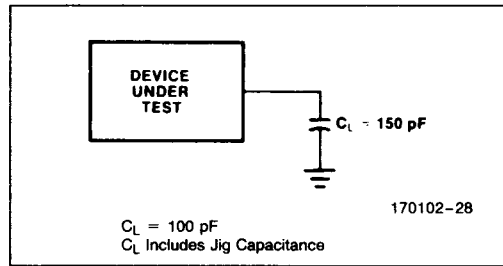

WAVEFORMS

CLOCK CYCLE

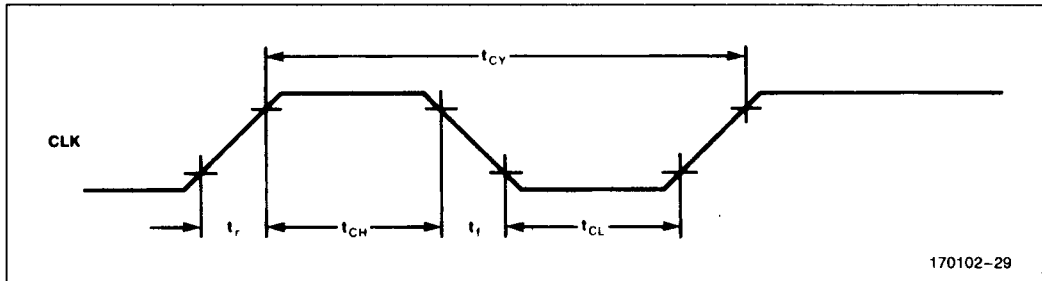

READ CYCLE

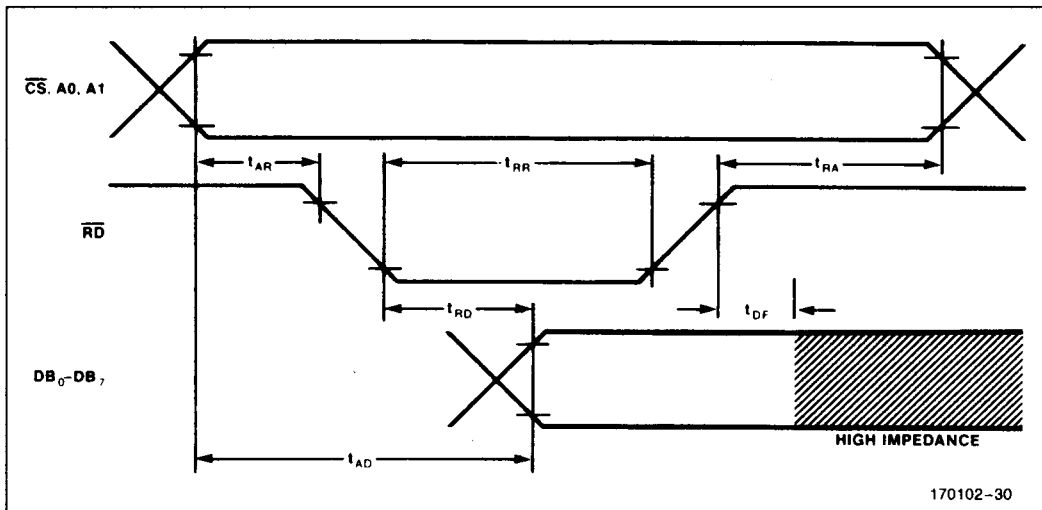

WAVEFORMS (Continued)

WRITE CYCLE

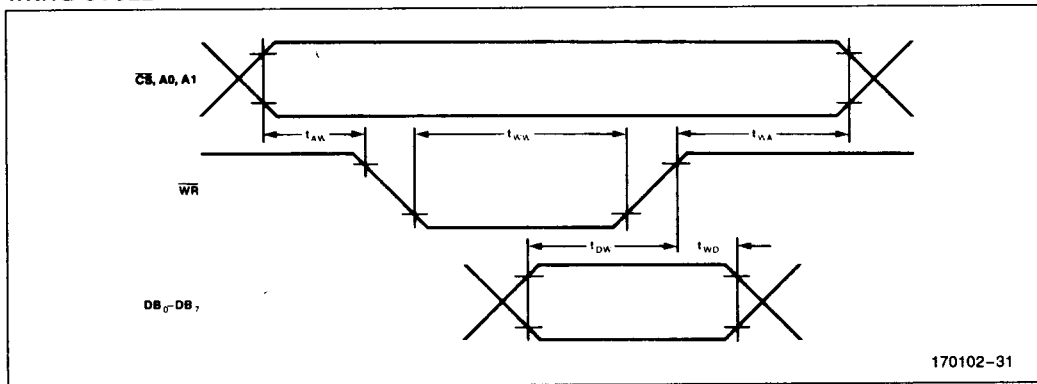

2

DMA CYCLE

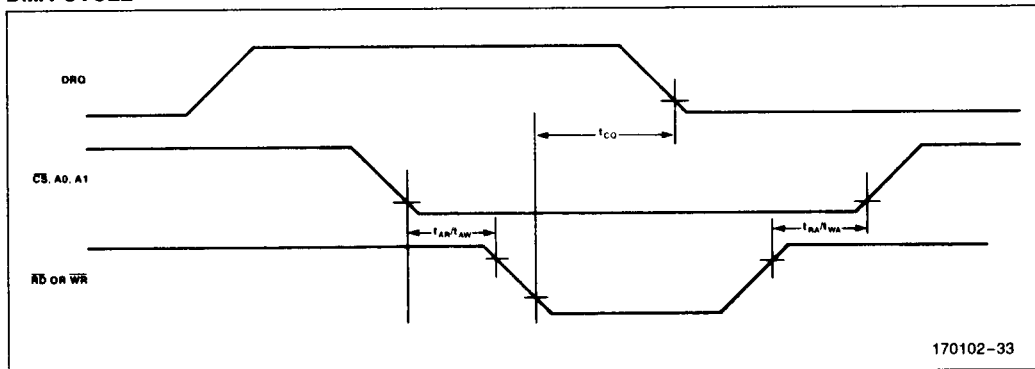

READ/WRITE CYCLE (SOFTWARE POLLED MODE)

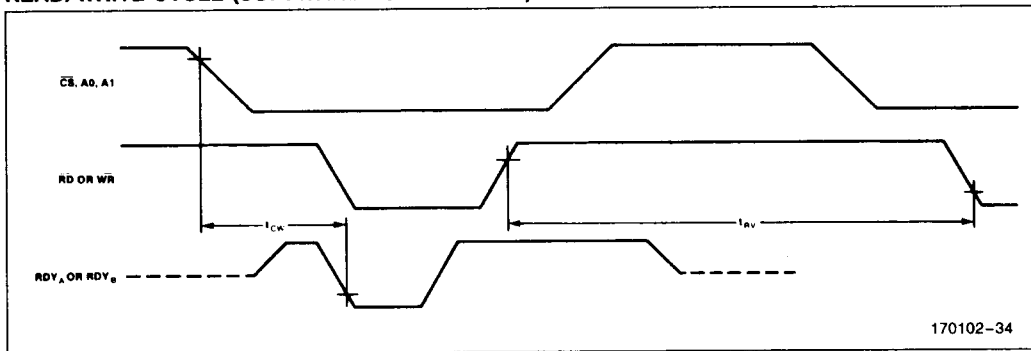

INTA CYCLE

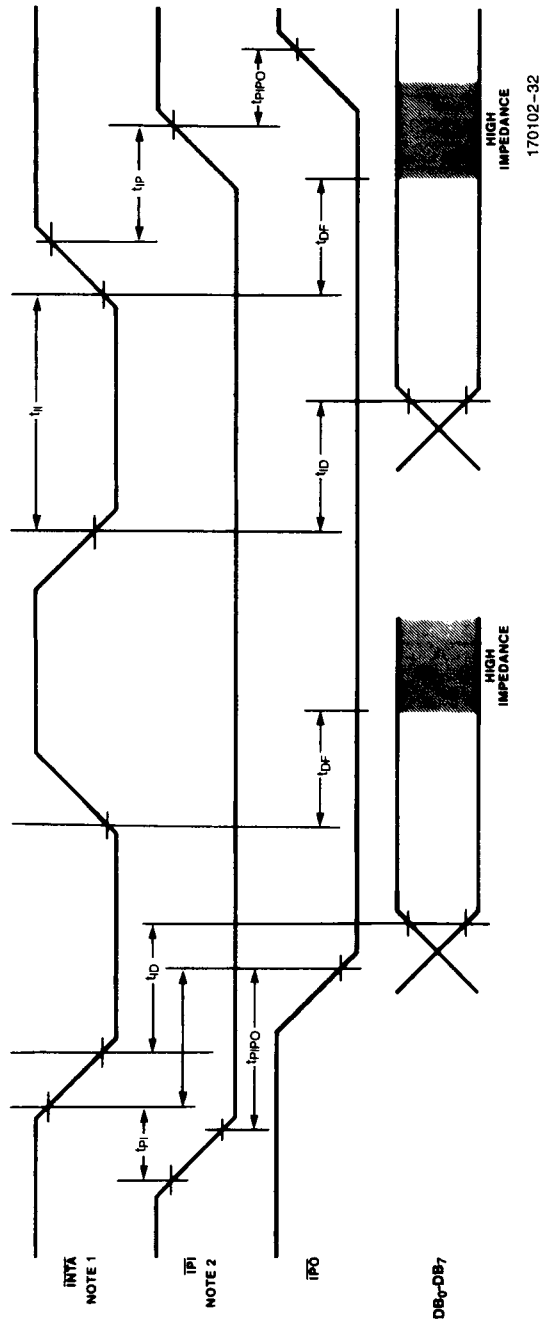

NOTES:

1. INTA signal as \overline{RD} signal.
2. IPI signal acts as CS signal.

WAVEFORMS (Continued)

TRANSMIT DATA CYCLE

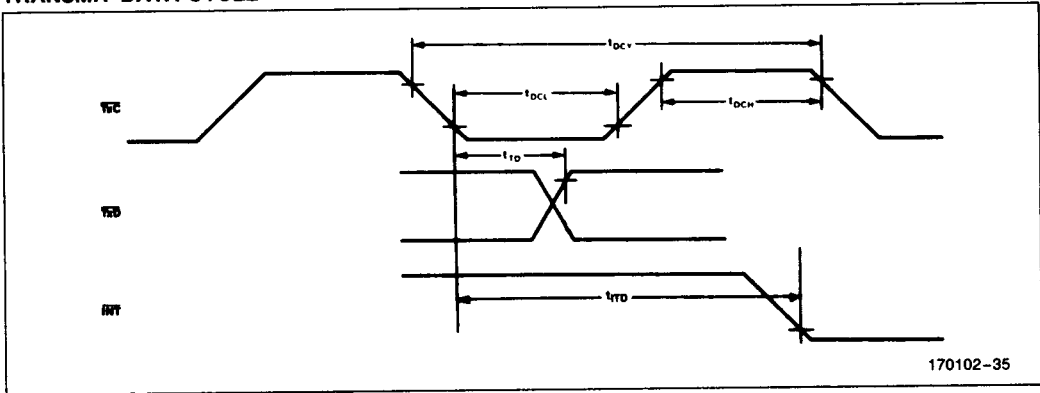

2

RECEIVE DATA CYCLE

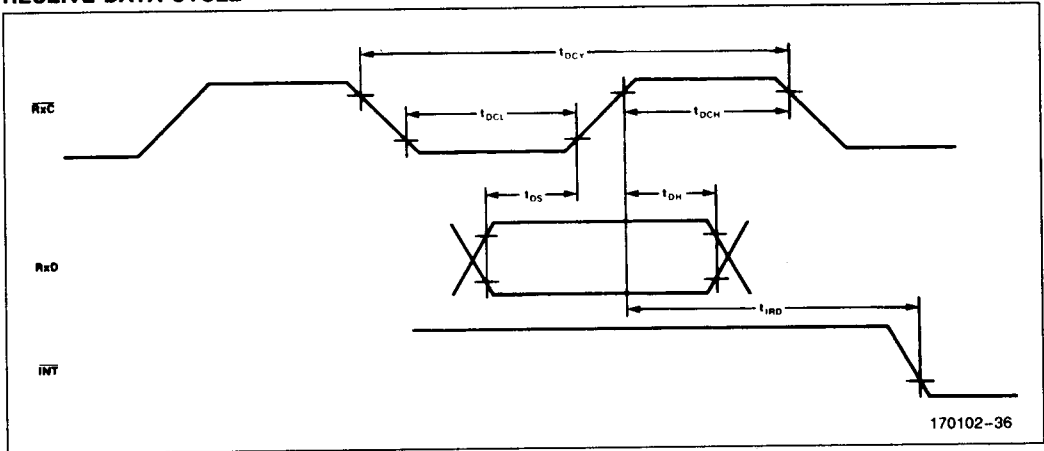

OTHER TIMING

