



TWC 319.5R
Thinnest
Wireless Contact
Compatible
with most
Interlogix® & Qolsys® Systems



TWC 345R
Thinnest
Wireless Contact
Compatible
with most
Honeywell® & 2GIG® Systems



TWC PIR345
INTERIOR
MOTION DETECTOR
Compatible
with most
Honeywell® & 2GIG®
Systems

HOME» PRODUCTS»» WIRELESS ALARM CONTACTS»» TWC PIR345 INSTRUCTION MANUAL-1

TWC PIR345 INSTRUCTION MANUAL

TANE ALARM PRODUCTS®
Wireless Interior Motion Detector
TWC PIR345
Instruction Manual

Congratulations:

Properly installed, your TANE ALARM PRODUCTS TWC PIR345 Interior PIR Motion Detector will provide dependable operation and security. Please read and follow these instructions carefully.

Product Design:

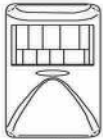

Front View

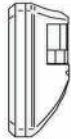

Side View



Back View

1. Parts description

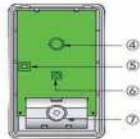
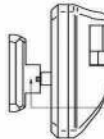
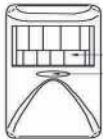

- ① Fresnel lens ② LED indicator ③ Ball Joint ④ Sensor
- ⑤ Tamper switch ⑥ LED indicator ⑦ Battery holder

2. PRODUCT DESCRIPTION

The TWC PIR345 utilizes a dual element pyroelectric infrared sensor. It's able to accurately detect the human infrared spectrum, and features a high-sensitivity setting with low false alarm rates. The transmission frequency of TWC PIR345 is 345MHz. This product is widely used for Banks, Post Offices, Malls, Private Homes, Jewelry Stores, Hotels and similar places where a high level of security is required. A signal is triggered by the following condition:

- 1) Human motion is detected;
- 2) The Tamper Switch is switched off or on;
- 3) The battery voltage is below the threshold of 2.6V;
- 4) Supervisory signal transmission is the interval of about 70 minutes.

3. PRODUCT SPECIFICATIONS

Sensing angle: 120°
Sensor range: 30 ft×40 ft.
Suggested Installation Height: 7.2 ft. above floor level
Sensor type: Dual element pyroelectric infrared sensor
Transmitter Frequency: 345 MHz
Wireless Signal Range: >300 ft (open air, line of sight)
Battery Type: One (1) CR2/CR15270 3V Lithium Battery or Equivalent
Battery Life: 3-5 years
Operating temperature: 14-122°F
Relative humidity: 5-90% no condensation
Dimension: 3.51 in×2.06 in×1.32 in

4. Installation Instructions:

4.1 Battery Installation

Unit:in(mm)

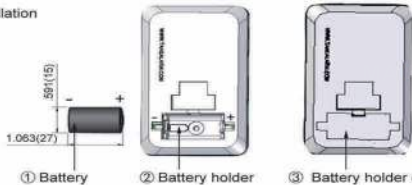

4.2 Jumper Installation

Motion detection sensitivity can be selected by a Jumper switch. The ON position is for High Sensitivity (detection distance is greater than 315 in(8m). The OFF position is for Normal Sensitivity (detection distance is less than 315 in(8m).

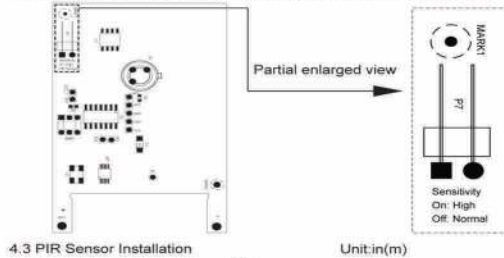

4.3 PIR Sensor Installation

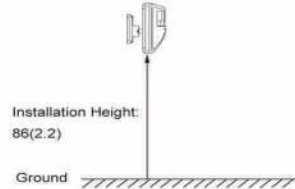

5. Operating Instructions

5.1 Warming up

After powering up, the red LED will start flashing, indicating the motion sensor is warming up. After 30 seconds, the LED will stop flashing, indicating the warm up is complete. The motion detector will then enter the Walk-Test Mode.

5.2 Walk-Test Mode

The Walk-Test mode is used to test the motion detector's pattern of coverage. Each time motion is detected the LED will remain on for about 6 seconds, and an alarm message will be transmitted.

When the LED goes out, the sensor is ready to detect motion again. If no motion has been detected for 2 minutes, or if 40 motions have been detected, the motion detector will exit the Walk-Test mode and enter the normal operation mode.

5.3 Normal Operation Mode

After completing the Walk-Test Mode, the motion detector will enter the Normal Operation Mode. In the Normal Operation Mode, if human motion is detected an alarm message will be transmitted immediately, and the motion detector will not transmit again for a period of 3 minutes.

In Normal Operation Mode, if the tamper switch is triggered, an alarm message will be transmitted immediately.

5.4 Low Battery

In Normal Operation Mode, the LED will flash when a low-battery condition is detected. The LED will continue to flash until the battery has been replaced, and the low battery condition has been corrected.

6. Caution

6.1 Choose the best tilt-angle and installation height to make sure human motion can be detected within the motion detector's pattern of coverage.

6.2 Avoid positions that are close to air conditioners, refrigerators, electric heaters, electric ovens, and other devices which can cause rapid temperature changes. Do not position the motion detector in direct sunlight or where significant vibration occurs.

7. Lens Pattern

7.1 Side View





TWC 319.5R
Thinnest
Wireless Contact
Compatible
with most
Interlogix® & Qolsys® Systems



TWC 345R
Thinnest
Wireless Contact
Compatible
with most
Honeywell® & 2GIG® Systems



TWC PIR345
INTERIOR
MOTION DETECTOR
Compatible
with most
Honeywell® & 2GIG®
Systems

HOME» PRODUCTS» WIRELESS ALARM CONTACTS» TWC PIR345 INSTRUCTION MANUAL-2

TWC PIR345 INSTRUCTION MANUAL

7.2 Top view

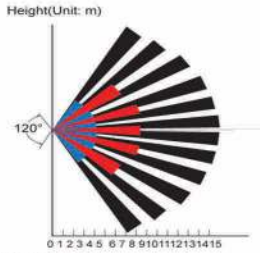

8. Mounting the PIR Sensor

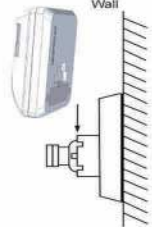
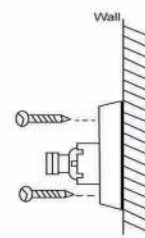
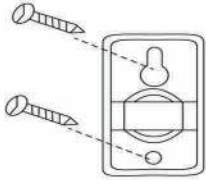

9. Product Dimensions

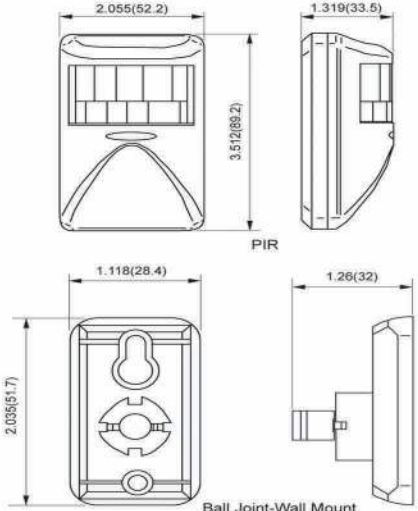

Unit:in(mm)

10. Important Installation and Use Tips

- 10.1 Do not install the motion detector where it will be exposed to bright lighting or direct sunlight.
- 10.2 Avoid installing the motion detector in a position where large objects will interfere with its pattern of coverage.
- 10.3 Do not install the motion detector near equipment such as air conditioners, heaters, etc.
- 10.4 To ensure proper functioning, the motion detector should be tested at least once every 6 months.

Limited Warranty

The Tane Alarm Products Best Product Guarantee since 1984@ TANE ALARM PRODUCTS guarantees NO STICKING and NO FALSE ALARMS. If during normal use you have a false alarm, contact us for a Return Merchandise Authorization – RMA*

Our engineers will test the PIR and upon their recommendation we will replace the defective PIR:

- If the PIR failed at installation (out of the box), we will replace it with \$20.00 in credit.
- If the PIR failed after installation (requiring a service call), we will replace it with \$50.00 in credit.
- If the PIR failed due to a high voltage surge or lightning strike, we will replace it two for one.

This life of the installation guarantee is non-transferable.

All other warranties are excluded.

There are no implied warranties of merchantability or fitness for any particular purpose.

FCC COMPLIANCE STATEMENT

CAUTION: Changes or modifications not expressly approved could void authority to use this equipment. This device complies with Part 15 of FCC Rules. Operation is subject to the following two conditions: (1) This device may not cause harmful interference, and (2) this device must accept any interference received, including interference that may cause undesired operation.

This equipment has been tested and found to comply with the limits for a Class B digital device, pursuant to Part 15 of the FCC Rules. These limits are designed to provide reasonable protection against harmful interference in a residential installation. This equipment generates, uses and can radiate radio frequency energy and, if not installed and used in accordance with the instructions, may cause harmful interference to radio communications. However, there is no guarantee that interference will not occur in a particular installation. If this equipment does cause harmful interference to radio or television reception, which can be determined by turning the equipment off and on, the user is encouraged to try to correct the interference by one or more of the following measures:

- Reorient or relocate the receiving antenna.
- Increase the separation between the equipment and receiver.
- Connect the equipment into an outlet on a circuit different from that to which the receiver is connected.

Consult the dealer or an experienced radio/television technician for help.

INDUSTRY CANADA STATEMENT

This device complies with Industry Canada license-exempt RSS standard(s). Operation is subject to the following two conditions: (1) this device may not cause interference, and (2) this device must accept any interference, including interference that may cause undesired operation of the device. Le présent appareil est conforme aux CNR d'Industrie Canada applicables aux appareils radio exempts de licence. L'exploitation est autorisée aux deux conditions suivantes: (1) l'appareil ne doit pas produire de brouillage, et (2) l'utilisateur de l'appareil doit accepter tout brouillage radioélectrique subi, même si le brouillage est susceptible d'en compromettre le fonctionnement.

Este equipo ha sido probado y está dentro de los límites para dispositivos digitales de la Clase B, en conformidad con la parte 15 de las Reglas de la FCC. Estos límites están diseñados para proporcionar una protección razonable contra interferencias perjudiciales en una instalación residencial. Este equipo genera, utiliza y puede irradiar energía de radiofrecuencia y, si no se instala y utiliza de acuerdo con las instrucciones, puede causar interferencias perjudiciales a las comunicaciones de radio. Sin embargo, esto no es una garantía que no produzca interferencias en alguna instalación en particular. Si este equipo causa interferencias perjudiciales de recepción por radio o televisión, lo cual se puede determinar apagando el equipo, se recomienda al usuario que trate de corregir la interferencia mediante una o más de las siguientes medidas:

- Re-ubique o cambie de lugar la antena receptora.
- Aumente la distancia entre el equipo y el receptor.
- Conecte el equipo a un toma corriente en un circuito diferente al que está conectado el receptor.
- Consulte al distribuidor o a un técnico de radio / TV con experiencia para que lo ayude.

MODEL: TWC PIR345
FCC ID: 2AU1X - TWCPIR345
IC: 21828 - TWCPIR345

TANE ALARM PRODUCTS
906 Jericho Turnpike,
New Hyde Park, NY 11040
Tel: 800-852-5050 • 516-328-3351
Fax: 516-328-9125
WWW.TANEALARM.COM
info@tanealarm.com



ISO9001 ISO14001

