

# Sure Cross® MultiHop H12 Data Radio



## Datasheet

The Sure Cross® wireless system is a radio frequency network with integrated I/O that operates in most environments to eliminate the need for wiring runs. Wireless MultiHop data radio networks are formed around a MultiHop master and one or more slaves and extend the range of a Modbus or other serial communication network.



- Wireless industrial I/O device with two NPN discrete inputs, two NMOS discrete outputs, two 0 to 20 mA analog inputs, one thermistor input, two SDI-12 inputs, and two switch power outputs
- Selectable transmit power levels of 250 mW or 1 Watt for 900 MHz models and 65 mW for 2.4 GHz models
- *FlexPower*® power options allow for 10 V DC to 30 V DC, solar, and battery power sources for low power applications.
- Self-healing, auto-routing radio frequency network with multiple hops extends the network's range and improves radio link performance
- Serial and I/O communication on a Modbus platform
- Message routing improves link performance
- DIP switches select operational modes: master, repeater, or slave
- Built-in site survey mode enables rapid assessment of a location's RF transmission properties
- Frequency Hopping Spread Spectrum (FHSS) technology ensures reliable data delivery

## Models

Models	Frequency	Supply Voltage	Housing	I/O
DX80DR9M-H12	900 MHz ISM Band	10 to 30 V dc or battery supply module	IEC IP67; NEMA 6	<b>Inputs:</b> Two NPN discrete, two 0 to 20 analog, one thermistor, and two SDI-12 <b>Outputs:</b> Two NMOS discrete <b>Switch Power:</b> Two (for SDI-12) <b>Serial interface:</b> RS-485
DX80DR9M-H12E		10 to 30 V dc or integrated battery	IEC IP65; NEMA 4X	
DX80DR2M-H12	2.4 GHz ISM Band	10 to 30 V dc or battery supply module	IEC IP67; NEMA 6	
DX80DR2M-H12E		10 to 30 V dc or integrated battery	IEC IP65; NEMA 4X	



DX80...C (IP20; NEMA 1) models are also available. To order this model with an IP20 housing, add a C to the end of the model number: DX80DR9M-H12C.

To order an integrated battery model without the battery, add a **-NB** to the model number. If you purchase a model without the battery, Banner Engineering recommends lithium D cell battery **BWA-BATT-001**.

## Configuration Instructions

### Setting Up Your MultiHop Network

To set up and install your wireless MultiHop network, follow these steps:

1. If your radios have DIP switches, configure the DIP switches of all devices.
2. Connect the sensors to the MultiHop radios if applicable.
3. Apply power to all devices.
4. If your MultiHop radio has rotary dials, set the MultiHop Radio (Slave) ID. If your MultiHop radio has no rotary dials, continue to the next step.
5. Form the wireless network by binding the slave and repeater radios to the master radio. If the binding instructions are not included in this datasheet, refer to the quick start guide or product manual.
6. Observe the LED behavior to verify the devices are communicating with each other.
7. Configure any I/O points to use the sensors connected to the Sure Cross devices.
8. Conduct a site survey between the MultiHop radios. If the site survey instructions are not included in this datasheet, refer to the product manual.
9. Install your wireless sensor network components. If the installation instructions are not included in this datasheet, refer to the product manual.

For additional information, refer to one of the following documents:

- MultiHop Data Radio Quick Start Guide: [152653](#)
- MultiHop Data Radio Instruction Manual: [151317](#)
- MultiHop Register Guide: [155289](#)



## Configure the DIP Switches

Before changing DIP switch positions, disconnect the power. Any changes made to the DIP switches are not recognized until after power is cycled to the device.

For devices powered by batteries integrated into the housing, triple-click button 2, then double-click button 2 to reset the device without removing the battery.

For parameters not set using the DIP switches, use the configuration software to make configuration changes. For parameters set using the DIP switches, the DIP switch positions override any changes made using the configuration software.

### Access the Internal DIP Switches

Follow these steps to access the internal DIP switches.



1. Unscrew the four screws that mount the cover to the bottom housing.
2. Remove the cover from the housing without damaging the ribbon cable or the pins the cable plugs into.
3. Gently unplug the ribbon cable from the board mounted into the bottom housing. Skip this step if there is no ribbon cable (integrated battery models) or the ribbon cable is glued down (C housing models).
4. Remove the black cover plate from the bottom of the device's cover.  
The DIP switches are located behind the rotary dials.
5. Make the necessary changes to the DIP switches.
6. Place the black cover plate back into position and gently push into place.
7. If necessary, plug the ribbon cable in after verifying that the blocked hole lines up with the missing pin.
8. Mount the cover back onto the housing.

### DIP Switch Settings (MultiHop)

Device Settings	Switches							
	1	2	3	4	5	6	7	8
Serial line baud rate 19200 OR User defined receiver slots	OFF <sup>1</sup>	OFF <sup>1</sup>						
Serial line baud rate 38400 OR 32 receiver slots	OFF	ON						
Serial line baud rate 9600 OR 128 receiver slots	ON	OFF						
Serial line baud rate Custom OR 4 receiver slots	ON <sup>2</sup>	ON <sup>2</sup>						
Parity: None			OFF <sup>1</sup>	OFF <sup>1</sup>				
Parity: Even			OFF	ON				
Parity: Odd			ON	OFF				
Disable serial (low power mode) and enable the receiver slots select for switches 1-2			ON <sup>2</sup>	ON <sup>2</sup>				
Transmit power 900 MHz radios: 1.00 Watt (30 dBm) 2.4 GHz radios: 0.065 Watts (18 dBm) and 60 ms frame					OFF <sup>1</sup>			
Transmit power 900 MHz radios: 0.25 Watts (24 dBm) 2.4 GHz radios: 0.065 Watts (18 dBm) and 40 ms frame					ON			
Application mode: Modbus						OFF <sup>1</sup>		
Application mode: Transparent						ON		
MultiHop radio setting: Repeater							OFF <sup>1</sup>	OFF <sup>1</sup>
MultiHop radio setting: Master							OFF	ON
MultiHop radio setting: Slave							ON <sup>2</sup>	OFF <sup>2</sup>
MultiHop radio setting: Reserved							ON	ON

<sup>1</sup> Default configuration

<sup>2</sup> Default configuration for the E housing models only

### Application Mode

The MultiHop radio operates in either Modbus mode or transparent mode. Use the internal DIP switches to select the mode of operation. All MultiHop radios within a wireless network must be in the same mode.

**Modbus** mode uses the Modbus protocol for routing packets. In Modbus mode, a routing table is stored in each parent device to optimize the radio traffic. This allows for point to point communication in a multiple data radio network and acknowledgement/retry of radio packets. To access a radio's I/O, the radios must be running in Modbus mode.

In **transparent** application mode, all incoming packets are stored, then broadcast to all connected data radios. The data communication is packet based and not specific to any protocol. The application layer is responsible for data integrity. For one to one data radios it is possible to enable broadcast acknowledgement of the data packets to provide better throughput. In transparent mode, there is no access to the radio's I/O.

### Baud Rate and Parity

The baud rate (bits per second) is the data transmission rate between the device and whatever it is physically wired to. Set the parity to match the parity of the device you are wired to.

### Disable Serial

Disable an unused local serial connection to reduce the power consumption of a data radio powered from the solar assembly or from batteries. All radio communications remain operational.

### Receiver Slots

The number of receiver slots indicates the number of times out of 128 slots/frames the radio can transmit to its parent radio. Setting a slave's receiver slots to four reduces the total power consumption by establishing that the slave can only transmit to its parent four times per 128 slots.

### Transmit Power Levels/Frame Size

The 900 MHz data radios can be operated at 1 watt (30 dBm) or 0.250 watt (24 dBm). For most models, the default transmit power is 1 watt.

For 2.4 GHz radios, the transmit power is fixed at 0.065 watt (18 dBm) and DIP switch 5 is used to set the frame timing. The default position (OFF) sets the frame timing to 60 milliseconds. To increase throughput, set the frame timing to 40 milliseconds. For battery-powered devices, increasing the throughput decreases battery life.



**Important:** Prior to date code 15341 and radio firmware version 3.6, the frame timing was 40 ms (OFF) or 20 ms (ON).

## Wire Your Sure Cross® Device

Use the following wiring diagrams to first wire the sensors and then apply power to the Sure Cross devices.

### Terminal Blocks and Wiring

Connecting power to the communication pins will cause permanent damage. For the DX80...C models, PWR in the wiring diagram refers to V+ on the wiring board. Refer to the Class I Division 2/Zone 2 control drawings (p/n 143086) for wiring specifications and limitations.

Figure 1. DR\*M-H12

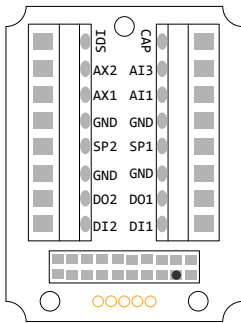

Figure 2. DR\*M-H12C

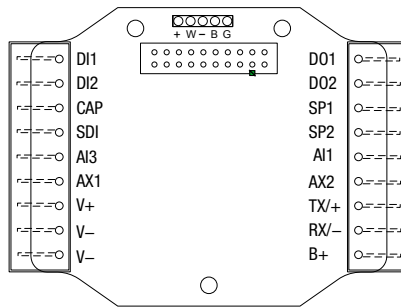
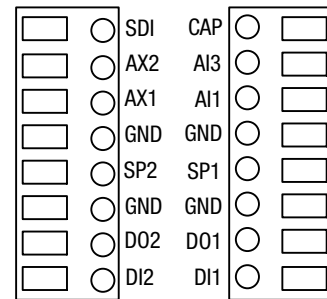

Figure 3. DR\*M-H12E



AIx or Ax. Analog IN x  
 AX1. Not used  
 AX2. Thermistor IN.  
 B+. 3.6 V DC to 5.5 V DC (use for battery powered models only)  
 CAP. Not used.  
 DIx. Discrete IN x

DOx. Discrete OUT x  
 GND. Ground/DC common connection  
 RX/-. Serial communication line for the Gateway. No connection for Nodes  
 SDI. SDI-12 IN

SPx. Switch Power; provides variable power sources for external devices  
 TX/+. Serial communication line for the Gateway; no connection for Nodes  
 V+. 10 V DC to 30 V DC power connection  
 V-. Ground/DC common connection

Figure 4. Discrete Input Wiring for PNP Sensors

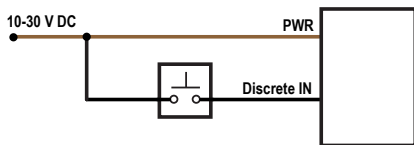

Figure 5. Discrete Input Wiring for NPN Sensors

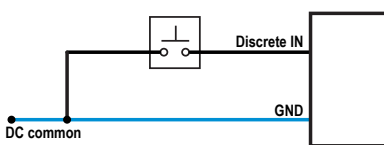

Figure 6. Discrete Output Wiring (NPN or NMOS)

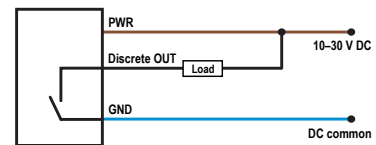

Figure 7. Analog Input Wiring (10-30 V DC Power)

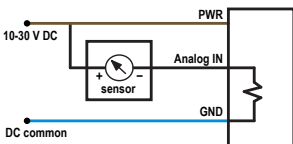

Figure 8. Thermistor Input

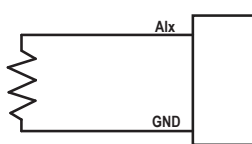
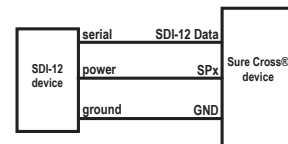

Figure 9. Input Wiring for SDI-12 Sensors



Do not exceed analog input ratings for analog inputs. Wire the thermistor for the M-H12 model to AX2. Wire the thermistor for the M-H12C model to AX1.

### Apply Power to the RS-485 FlexPower MultiHop Model

Connecting power to the communication pins will cause permanent damage. For FlexPower devices, do not apply more than 5.5 V to the gray wire. The FlexPower MultiHop radios operate equally well when powered from the brown or gray wire; it is not necessary to supply both. The power for the sensors can be supplied by the radio's SPx terminals or from the 10 V DC to 30 V DC used to power the radio.

5-pin M12 Male Quick Disconnect Connector	Pin	Wire Color	Wiring Description
	1	Brown (bn)	10 V DC to 30 V DC
	2	White (wh)	RS-485 / D1 / B / +
	3	Blue (bu)	DC common (GND)
	4	Black (bk)	RS-485 / D0 / A / -
	5	Gray (gy)	3.6 V DC to 5.5 V DC

### Apply Power to the DX80...M-HxC Model

Connecting power to the communication pins will cause permanent damage. For *FlexPower* devices, do not apply more than 5.5 V to the gray wire. The FlexPower MultiHop radios operate equally well when powered from the brown or gray wire; it is not necessary to supply both. The power for the sensors can be supplied by the radio's SPx terminals or from the 10 V DC to 30 V DC used to power the radio.

Terminal	Wiring Description	Terminal	Wiring Description
V+	10 V DC to 30 V DC	Rx/-	RS-485 / D0 / A / -
Tx/+	RS-485 / D1 / B / +	B+	3.6 V DC to 5.5 V DC
V-	DC common (GND)		

### Apply Power to the DX80...E Radios

Connecting power to the communication pins will cause permanent damage. The integrated battery DX80...E radios may also be powered by 10 V DC to 30 V DC. The power for the sensors can be supplied by the radio's SPx terminals or from the 10 V DC to 30 V DC used to power the radio. The BAT connection is a low voltage connection to the internal battery. Remove the internal battery if a low voltage source is connected to the BAT terminal. When powering the device from the integrated battery, the BAT connection must remain open.

		Integrated battery (RS-485) for P1E, M-H1E, M-H12E, and P16E Models	Integrated battery (RS-232) for P3E, P4E, M-H3E, and M-H4E Models
	1	10 V DC to 30 V DC (optional)	10 V DC to 30 V DC (optional)
	2	RS-485 / D1 / B / +	RS-232 Tx
	3	DC common (GND)	DC common (GND)
	4	RS-485 / D0 / A / -	RS-232 Rx

### Set the MultiHop Radio (Slave) ID

The slave ID is an identifying number used for devices within a Modbus system. When using more than one Modbus slave, assign each slave a unique ID number.

For MultiHop radios with rotary dials, use the rotary dials to set the device's MultiHop Radio ID. The left dial sets the left digit and the right dial sets the right digit.

- Modbus Slave IDs 01 through 10—Reserved for slaves directly connected to the host (local I/O). Polling messages addressed to these devices are not relayed over the wireless link.
- Modbus Slave IDs 11 through 60—Use for MultiHop master, repeater, and slave radios. Up to 50 devices (local slaves and remote slaves) may be used in this system.

If your MultiHop radio does not have rotary dials, you must use the master radio to set the Slave ID during the binding process.

### MultiHop Configuration Software

Use Banner's MultiHop Configuration Software to view your MultiHop radio network and configure the radio and its I/O.

Figure 10. MultiHop Configuration Software Network and Device Overview screen

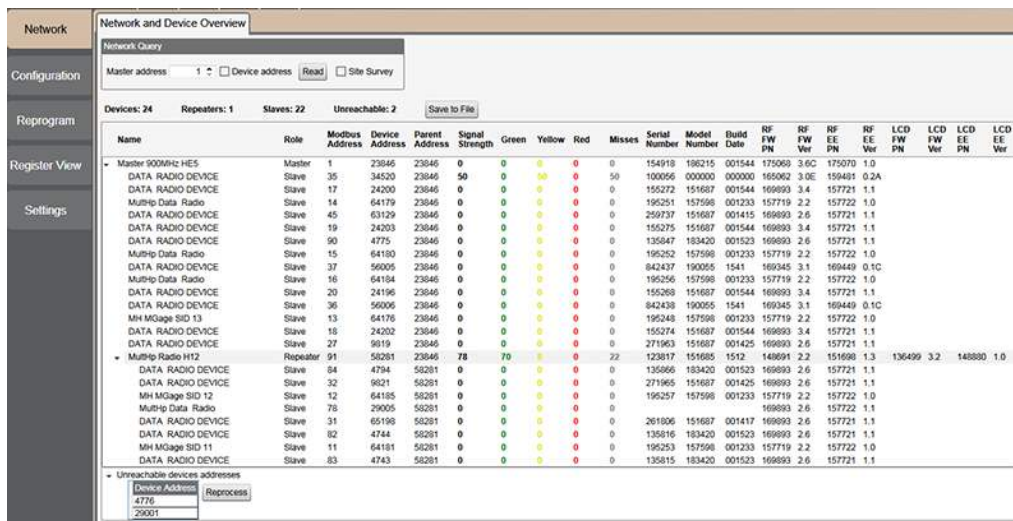

The software connects to a MultiHop master radio using one of four methods.

- Serial; using a USB to RS-485 (for RS-485 radios) or a USB to RS-232 (for RS-232 radios) converter cable.
- Modbus TCP; using an Ethernet connection to an Ethernet radio master.
- Serial DXM; using a USB cable to a DXM Controller to access a MultiHop master radio.
- TCP DXM; using an Ethernet connection to a DXM Controller to access a MultiHop master radio.

For MultiHop DX80DR9\* models, Banner recommends using **BWA-UCT-900**, an RS-485 to USB adapter cable with a wall plug that can power your 900 MHz 1 Watt MultiHop radio while you configure it. The adapter cable is not required when connecting to a DXM Controller.

Download the most recent software revision from the Wireless Reference Library on Banner Engineering's website: [www.bannerengineering.com](http://www.bannerengineering.com).

### Configuring the SDI-12 Inputs

The SDI-12 interface on the MultiHop radio can support up to five devices with (12) 32-bit register values each. The radio's SDI-12 interface can be configured to increase the number of registers per device address for devices with large register sets. The factory default enables one SDI-12 device using device address 1 with up to nine registers with a SDI-12 command of "M!".

Configure the MultiHop device by writing to non-volatile Modbus registers with configuration parameters. Read or write the device configuration parameters using standard Modbus commands. For more information about manually configuring the SDI-12 interface, refer to the MultiHop Register Parameter document, p/n 155289.

### Basic SDI-12 Interface Parameters

Up to five devices/commands can be accessed using the SDI-12 interface. There are three parameters for each device/command: Enable, Device Address, Device Command. For more information, refer to the SDI-12 Technical Notes.

**Enable.** Instructs the MultiHop Radio device to activate or deactivate the SDI-12 device. Write a 1 to enable, and write a 0 to disable. The factory default for device 1 is enabled; devices 2 through 5 are disabled.

**Device Address.** Each SDI-12 device must have a unique device address. This parameter is the ASCII code for the device address. Valid device addresses are 0–9 and a–z that map to ASCII codes 48–57 and 97–122, respectively. The factory default addresses are:

- SDI-12 Device 0 uses ASCII code 48
- SDI-12 Device 1 uses ASCII code 49
- SDI-12 Device 2 uses ASCII code 50
- SDI-12 Device 3 uses ASCII code 51
- SDI-12 Device 4 uses ASCII code 52

**Device Command** The SDI-12 interface supports "M!" or "C!" commands. Use the Device Command parameter to define which command to use for this device. The factory default is "M!" commands for all devices (value of 10 in the Modbus register).

Supported MI Commands		Supported CI Commands	
SDI-12 Command	Register Value	SDI-12 Command	Register Value
xM!	0 or 10	xC!	1 or 20
xM1!	11	xC1!	21
xM2!	12	xC2!	22
xM3!	13	xC3!	23
xM4!	14	xC4!	24
xM5!	15	xC5!	25
xM6!	16	xC6!	26
xM7!	17	xC7!	27
xM8!	18	xC8!	28
xM9!	19	xC9!	29

The Modbus configuration registers are listed. All registers are defined as Modbus holding registers. The factory default values are shown in parentheses. All values are in decimal, unless noted otherwise.

Device/CMD Configuration	Registers (Default Value)		
	Enable	Device Address	Device Command
SDI-12 Device/CMD 1	1751 (1)	11001 (48) <sup>1</sup>	11002 (10)
SDI-12 Device/CMD 2	1701 (0)	11201 (49)	11202 (10)
SDI-12 Device/CMD 3	1651 (0)	11401 (50)	11402 (10)
SDI-12 Device/CMD 4	1601 (0)	11601 (51)	11602 (10)
SDI-12 Device/CMD 5	1551 (0)	11801 (52)	11802 (10)

### SDI-12 Device Result Registers

The result registers store all information received from the SDI-12 devices.

The registers are 16-bit registers and require two registers to store a 32-bit value. The factory default configuration defines the result registers as 32-bit registers, floating point format, and the first nine result registers are enabled for use. A host system reads the SDI-12 device data from these registers.

Result Registers	Register 1	Register 2	Register 3	Register 4	Register 5	Register 6
SDI-12 Device/CMD 1 Result Upper	11101	11103	11105	11107	11109	11111
SDI-12 Device/CMD 1 Result Lower	11102	11104	11106	11108	11110	11112
SDI-12 Device/CMD 2 Result Upper	11301	11303	11305	11307	11309	11311
SDI-12 Device/CMD 2 Result Lower	11302	11304	11306	11308	11310	11312
SDI-12 Device/CMD 3 Result Upper	11501	11503	11505	11507	11509	11511
SDI-12 Device/CMD 3 Result Lower	11502	11504	11506	11508	11510	11512
SDI-12 Device/CMD 4 Result Upper	11701	11703	11705	11707	11709	11711
SDI-12 Device/CMD 4 Result Lower	11702	11704	11706	11708	11710	11712
SDI-12 Device/CMD 5 Result Upper	11901	11903	11905	11907	11909	11911
SDI-12 Device/CMD 5 Result Lower	11902	11904	11906	11908	11910	11912

Result Registers	Register 7	Register 8	Register 9	Register 10	Register 11	Register 12
SDI-12 Device/CMD 1 Result Upper	11113	11115	11117	11119	11121	11123
SDI-12 Device/CMD 1 Result Lower	11114	11116	11118	11120	11122	11124

<sup>1</sup> The default device addresses 48 through 52 are in ASCII.

Result Registers	Register 7	Register 8	Register 9	Register 10	Register 11	Register 12
SDI-12 Device/CMD 2 Result Upper	11313	11315	11317	11319	11321	11323
SDI-12 Device/CMD 2 Result Lower	11314	11316	11318	11320	11322	11324
SDI-12 Device/CMD 3 Result Upper	11513	11515	11517	11519	11521	11523
SDI-12 Device/CMD 3 Result Lower	11514	11516	11518	11520	11522	11524
SDI-12 Device/CMD 4 Result Upper	11713	11715	11717	11719	11721	11723
SDI-12 Device/CMD 4 Result Lower	11714	11716	11718	11720	11722	11724
SDI-12 Device/CMD 5 Result Upper	11913	11915	11917	11919	11921	11923
SDI-12 Device/CMD 5 Result Lower	11914	11916	11918	11920	11922	11924

## SDI-12 Device Settings

Device / Cmd Configuration	Registers (Default Value)							
	Enable	Device Address	Switch Power Enable	Device Command	Sample HI	Sample Low	Warmup Time	Voltage
SDI-12 Device/CMD 1	1751 (1)	11001 (48) <sup>2</sup>	1754 (1)	11002 (10)	1752 (0)	1753 (22500)	1755 (50)	1756 (148)
SDI-12 Device/CMD 2	1701 (0)	11201 (49)	1704 (0)	11202 (10)	1702 (0)	1703 (22500)	1705 (50)	1706 (148)
SDI-12 Device/CMD 3	1651 (0)	11401 (50)	1654 (0)	11402 (10)	1652 (0)	1653 (22500)	1655 (50)	1656 (148)
SDI-12 Device/CMD 4	1601 (0)	11601 (51)	1604 (0)	11602 (10)	1602 (0)	1603 (22500)	1605 (50)	1606 (148)
SDI-12 Device/CMD 5	1551 (0)	11801 (52)	1554 (0)	11802 (10)	1552 (0)	1553 (22500)	1555 (50)	1556 (148)

These SDI-12 probes have been tested and are functional with the factory default settings.

MFG	Models	Technical Note
Acclima	SEN-SDI (TDT SDI-12 Soil Moisture Sensor)	<a href="#">SDI-12 and the Acclima TDT SDI-12 Soil Moisture Probe</a>
Adcon Telemetry	HydraProbell	
AquaCheck	Sub-surface Probe	<a href="#">SDI-12 and the AquaCheck Sub-Surface Soil Moisture Probe</a>
Decagon	MPS-2, MPS-6, 5TE, TS1, T8	<a href="#">SDI-12 and the Decagon 5TE Soil Moisture Probe</a> <a href="#">SDI-12 and the Decagon GS3 Soil Moisture Probe</a> <a href="#">SDI-12 and the Decagon MPS-2 Soil Moisture Probe</a>
HSTI	HydraScout	<a href="#">SDI-12 and the HydraScout HSTI Probe</a>
Sentek	EnviroSCAN	<a href="#">SDI-12 and the Sentek EnviroScan Soil Moisture Probe</a>

## Installing Your Sure Cross® Radios

Please refer to one of these instruction manuals to install your wireless network components.

- Performance Wireless I/O Network Instruction Manual: [132607](#)
- MultiHop Data Radio Instruction Manual: [151317](#)

## Modbus Registers

Register (4xxx)	Input #	Inputs	Units	I/O Range		Holding Register Representation		Terminal Block Labels
				Min. Value	Max. Value	Min. (Dec.)	Max. (Dec.)	
1	1	Discrete IN 1	-	0	1	0	1	DI1
2	2	Discrete IN 2	-	0	1	0	1	DI2
	...							
5	5	Analog IN 1 *	mA	0.0	20.0	0	65535	AI1
6	6							
7	7	Analog IN 2 *	mA	0.0	20.0	0	65535	AI3
8	8	Thermistor *	°F	-1638.3	1638.4	-32768	32767	AXx <sup>3</sup>
9	9							
10	10							
11	11							
12	12	SDI-12 Device/CMD 5 *						SDI
13	13	SDI-12 Device/CMD 4 *						SDI
14	14	SDI-12 Device/CMD 3 *						SDI
15	15	SDI-12 Device/CMD 2 *						SDI
16	16	SDI-12 Device/CMD 1						SDI

\* The factory default setting for SDI-12 devices 2 through 5, analog inputs 1 and 2, and the thermistor are disabled.

<sup>2</sup> The default device addresses 48 through 52 are in ASCII.

<sup>3</sup> Using AX2 for the M-H12 models and AX1 for the M-H12C models.

Register (4xxx)	Output #	Outputs	Units	I/O Range		Holding Register Representation		Terminal Block Labels
				Min. Value	Max. Value	Min. (Dec.)	Max. (Dec.)	
501	1	Discrete OUT 1	-	0	1	0	1	DO1
502	2	Discrete OUT 2	-	0	1	0	1	DO2
503	3	Switch Power 1						SP1
504	4	Switch Power 2						SP2

## Modbus Addressing Convention

All Modbus addresses refer to Modbus holding registers. When writing your own Modbus scripts, use the appropriate commands for interfacing to holding registers. Parameter description headings refer to addresses in the range of 40000 as is customary with Modbus convention.

## Storage and Sleep Modes

**Storage Mode** (applies to battery-powered models only)—While in **storage mode**, the radio does not operate. To put any integrated battery Sure Cross® radio into storage mode, press and hold button 1 for five seconds. To wake the device, press and hold button 1 for five seconds. The radio is in storage mode when the LEDs stop blinking, but in some models, the LCD remains on for an additional minute after the radio enters storage mode. After a device has entered storage mode, you must wait one minute before waking it.

**Sleep Mode** (applies to both battery and 10–30 V DC powered models)—During normal operation, the Sure Cross radio devices enter **sleep mode** after 15 minutes of operation. The radio continues to function, but the LCD goes blank. To wake the device, press any button.

## Install or Replace the Battery on a DX80E Model

To replace the lithium "D" cell battery or batteries in any DX80E model, follow these steps.

1. Remove the four screws mounting the face plate to the housing and remove the face plate. If there is a radio cover on the faceplate, do not remove the radio cover from the face plate.
2. If applicable, remove the discharged battery or batteries.
3. Install the new battery or batteries.
4. Verify the positive and negative terminals align to the positive and negative terminals of the battery holder mounted within the case.
5. Allow up to 60 seconds for the device to power up.
6. Properly dispose of used batteries according to local regulations by taking it to a hazardous waste collection site, an e-waste disposal center, or other facility qualified to accept lithium batteries.



**CAUTION:** There is a risk of explosion if the battery is replaced incorrectly.

For outside or high humidity environments, dielectric grease may be applied to the battery terminals to prevent moisture and corrosion buildup.

As with all batteries, these are a fire, explosion, and severe burn hazard. Do not burn or expose them to high temperatures. Do not recharge, crush, disassemble, or expose the contents to water.

For non-hazardous locations, the replacement battery is model **BWA-BATT-011**. For non-hazardous or hazardous locations, the replacement battery is Xeno model XL-205F, Banner model **BWA-BATT-001**. For pricing and availability, contact Banner Engineering.

## Specifications

### MultiHop Radio Specifications

#### Radio Range<sup>‡</sup>

900 MHz, 1 Watt: Up to 9.6 km (6 miles)  
2.4 GHz, 65 mW: Up to 3.2 km (2 miles)

#### Antenna Minimum Separation Distance

900 MHz, 150 mW and 250 mW: 2 m (6 ft)  
900 MHz, 1 Watt: 4.57 m (15 ft)  
2.4 GHz, 65 mW: 0.3 m (1 ft)

#### Radio Transmit Power

900 MHz, 1 Watt: 30 dBm (1 W) conducted (up to 36 dBm EIRP)  
2.4 GHz, 65 mW: 18 dBm (65 mW) conducted, less than or equal to 20 dBm (100 mW) EIRP

#### Spread Spectrum Technology

FHSS (Frequency Hopping Spread Spectrum)

#### Antenna Connection

Ext. Reverse Polarity SMA, 50 Ohms  
Max Tightening Torque: 0.45 N·m (4 lbf·in)

#### Radio Packet Size (MultiHop)

900 MHz: 175 bytes (85 Modbus registers)  
2.4 GHz: 75 bytes (37 Modbus registers)

#### 900 MHz Compliance (1 Watt)

FCC ID UE3RM1809: FCC Part 15, Subpart C, 15.247  
IC: 7044A-RM1809  
IFT: RCPBARM13-2283



(NOM approval only applies to 900 MHz models)

#### 2.4 GHz Compliance (MultiHop)

FCC ID UE300DX80-2400: FCC Part 15, Subpart C, 15.247  
Radio Equipment Directive (RED) 2014/53/EU  
IC: 7044A-DX8024

ANATEL: 15966-21-04042 Este equipamento não tem direito à proteção contra interferência prejudicial e não pode causar interferência em sistemas devidamente autorizados. Para maiores informações, consulte o site da ANATEL [www.gov.br/anatel/pt-br/](http://www.gov.br/anatel/pt-br/)

<sup>‡</sup> Radio range is with the 2 dB antenna that ships with the product. High-gain antennas are available, but the range depends on the environment and line of sight. Always verify your wireless network's range by performing a Site Survey.



## RS-485 Communication Specifications

### Communication Hardware (MultiHop RS-485)

Interface: 2-wire half-duplex RS-485  
 Baud rates: 9.6k, 19.2k (default), or 38.4k via DIP switches; 1200 and 2400 via the MultiHop Configuration Software  
 Data format: 8 data bits, no parity, 1 stop bit

## MultiHop M-H12 Specifications

### Supply Voltage

M-H12 or "C" Housing Models: 10 V DC to 30 V DC (Outside the USA: 12 V DC to 24 V DC,  $\pm 10\%$ ) on the brown wire, or 3.6 V DC to 5.5 V DC low power option on the gray wire<sup>5</sup>  
 "E" Housing Models: 3.6 V DC (internal battery) or 10 V DC to 30 V DC

### Power Consumption

Master radio consumption (900 MHz): Maximum current draw is < 100 mA and typical current draw is < 30 mA at 24 V DC. (2.4 GHz consumption is less.)  
 Repeater/slave radio consumption (900 MHz): Maximum current draw is < 40 mA and typical current draw is < 20 mA at 24 V DC. (2.4 GHz consumption is less.)

### Discrete Inputs

Rating: 3 mA max current at 30 V DC  
 Sample Rate: 40 milliseconds  
 ON Condition (NPN): Less than 0.7 V  
 OFF Condition (NPN): Greater than 2 V or open

### Thermistor Input (MultiHop)

Model: Omega's 44006 or 44031 family of 10 kOhm thermistors  
 Sample Rate: 1 second  
 Accuracy: 0.4 °C (10 °C to 50 °C); Up to 0.8 °C (-40 °C to 85 °C)

### Discrete Output

ON Condition: Less than 0.7 V  
 OFF Condition: Open

### Discrete Output Rating (MultiHop NMOS)

Less than 1 A max current at 30 V DC  
 ON-State Saturation: Less than 0.7 V at 20 mA

### Certifications



**Banner Engineering Europe**  
 Park Lane, Culliganlaan 2F bus  
 3, 1831 Diegem, BELGIUM  
 (CE approval only applies  
 to 2.4 GHz models)

### Housing

Polycarbonate housing and rotary dial cover; polyester labels; EDPM rubber cover gasket; nitrile rubber, non-sulphur cured button covers  
 Weight: 0.26 kg (0.57 lbs)  
 Mounting: #10 or M5 (SS M5 hardware included)  
 Max. Tightening Torque: 0.56 N-m (5 lbf-in)

### Interface

Two bi-color LED indicators, Two buttons, Six character LCD

### Wiring Access

M-H12 models: Four PG-7, one 1/2-inch NPT, one 5-pin M12 male quick-disconnect connector  
 "C" Housing Models: External terminals  
 "E" Housing Models: Two 1/2-inch NPT

### Analog Inputs

Rating: 24 mA  
 Impedance: Approximately 22 Ohms<sup>6</sup>  
 Sample Rate: 1 second  
 Accuracy: 0.1% of full scale  $\pm 0.01\%$  per °C  
 Resolution: 12-bit

### Certifications for DX8x...C (External Wiring Terminal) and DX8x...E Models



CSA: Class 1 Division 2 Groups ABCD, Class 1 Zone 2 AEx/Ex nA II T4 — Certificate: 1921239



ATEX: II 3 G Ex nA IIC T4 Gc (Group IIC Zone 2) — Certificate LCIE 10 ATEX 1012 X

Refer to the Class I Division 2/Zone 2 control drawings (p/n 143086) for wiring specifications and limitations. Install the device in a suitable enclosure with provision for connection of Division 2 / Zone 2 wiring methods in accordance with local codes, as acceptable to the local inspection authority having jurisdiction. All battery-powered devices must only use the lithium battery manufactured by Xenon, model XL-205F (Banner model number **BWA-BATT-001**).

## Environmental Specifications

### Operating Conditions

-40 °C to +85 °C (-40 °F to +185 °F) (Electronics); -20 °C to +80 °C (-4 °F to +176 °F) (LCD)  
 95% maximum relative humidity (non-condensing)  
 Radiated Immunity: 10 V/m (EN 61000-4-3)

### Shock and Vibration

All models meet IEC 60068-2-6 and IEC 60068-2-27 testing criteria  
 Shock: 30G 11 ms duration, half sine wave per IEC 60068-2-27  
 Vibration: 10 Hz to 55 Hz, 0.5 mm peak-to-peak amplitude per IEC 60068-2-6

### Environmental Ratings

IEC IP67; NEMA 6  
 For installation and waterproofing instructions, go to [www.bannerengineering.com](http://www.bannerengineering.com) and search for the complete instruction manual (p/n 151317)

Operating the devices at the maximum operating conditions for extended periods can shorten the life of the device.

## Environmental Specifications for the C Housings

### Operating Conditions

-40 °C to +85 °C (-40 °F to +185 °F) (Electronics); -20 °C to +80 °C (-4 °F to +176 °F) (LCD)  
 95% maximum relative humidity (non-condensing)  
 Radiated Immunity: 10 V/m (EN 61000-4-3)

### Shock and Vibration

All models meet IEC 60068-2-6 and IEC 60068-2-27 testing criteria  
 Shock: 30G 11 ms duration, half sine wave per IEC 60068-2-27  
 Vibration: 10 Hz to 55 Hz, 0.5 mm peak-to-peak amplitude per IEC 60068-2-6

### Environmental Ratings

"C" Housing Models/External wiring terminals: IEC IP20; NEMA 1  
 Refer to the Sure Cross® DX80 Performance (p/n 132607) or the Sure Cross® MultiHop (p/n 151317) instruction manual for installation and waterproofing instructions.

Operating the devices at the maximum operating conditions for extended periods can shorten the life of the device.

## Environmental Specifications for the E Housing

### Operating Conditions

-40 °C to +85 °C (-40 °F to +185 °F) (Electronics); -20 °C to +80 °C (-4 °F to +176 °F) (LCD)  
 95% maximum relative humidity (non-condensing)  
 Radiated Immunity: 10 V/m (EN 61000-4-3)

### Shock and Vibration

All models meet IEC 60068-2-6 and IEC 60068-2-27 testing criteria  
 Shock: 30G 11 ms duration, half sine wave per IEC 60068-2-27  
 Vibration: 10 Hz to 55 Hz, 0.5 mm peak-to-peak amplitude per IEC 60068-2-6

### Environmental Ratings

IP65  
 Refer to the Sure Cross® DX80 Performance (p/n 132607) or the Sure Cross® MultiHop (p/n 151317) instruction manual for installation and waterproofing instructions.

Operating the devices at the maximum operating conditions for extended periods can shorten the life of the device.

## Accessories

### Included with the DX80 and DX80...C Models

- **BWA-HW-002:** DX80 Access Hardware Kit, containing four PG-7 plastic threaded plugs, four PG-7 nylon gland fittings, four PG-7 hex nuts, one 1/2-inch NPT plug, and one 1/2-inch nylon gland fitting. (Not included with IP20 DX80...C models)

<sup>5</sup> For European applications, power this device from a Limited Power Source as defined in EN 60950-1.

<sup>6</sup> To verify the analog input's impedance, use an Ohm meter to measure the resistance between the analog input terminal (Alx) and the ground (GND) terminal.



- **BWA-HW-001:** Mounting Hardware Kit, containing four M5-0.8 × 25mm SS screws, four M5-0.8 × 16 mm SS screws, four M5-0.8 mm SS hex nuts, and four #8-32 × 3/4" SS bolts
- **BWA-HW-003:** PTFE tape
- **BWA-902-C** (900 MHz) or **BWA-202-C** (2.4 GHz): Antenna, 2 dBd Omni, Rubber Swivel RP-SMA Male (not included with internal antenna models)
- **MQDC1-506:** 5-pin M12 (single ended) straight cordset, 2 m (not included with FlexPower devices)
- **BWA-HW-011:** IP20 Screw Terminal Headers (2 pack) (included only with the IP20 DX80...C models)
- Product datasheet and product family Quick Start Guide ([128185](#) for Performance models or [152653](#) for MultiHop models)

### Included with the DX80..E Models

- Mounting hardware kit
- BWA-HW-003: PTFE tape
- BWA-902-C (900 MHz) or BWA-202-C (2.4 GHz): Antenna, 2 dBd Omni, Rubber Swivel RP-SMA Male. (Not included with Internal antenna models)
- BWA-BATT-001: Replacement battery, 3.6 Volt, "D" Lithium Cell
- BWA-HW-032: Access Hardware for "E" Housing (One each of 1/2-inch plug, 1/2-inch gland)
- Product datasheet and product family Quick Start Guide ([128185](#) for DX80 Gateways or [152653](#) for MultiHop models)

### Thermistor Probes

#### BWA-THERMISTOR-PROBE-003

- Temperature sensor with thermistor **PS103G2**
- Beta Value(K) 0–50°C: 3575
- Base thermistor accuracy of 0.2%
- Operating Temperature Range: –20 °C to +105 °C (–4 °F to +221 °F)
- Maximum Power Rating: 30 mW at 25 °C; derated to 1 mW at 125 °C
- Dissipation Constant: 1 mW/°C
- 316 stainless steel finish; PVC insulation

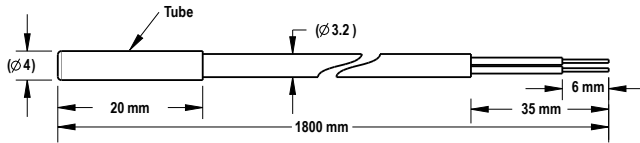

### Splitter Cordsets

5-Pin Threaded M12 Splitter Cordset with Flat Junction—Double Ended				
Model	Trunk (Male)	Branches (Female)	Pinout (Male)	Pinout (Female)
CSB4-M1251M1250	0.3 m (0.98 ft)	Four (no cable)		
			1 = Brown 2 = White 3 = Blue	4 = Black 5 = Gray

5-Pin Threaded M12 Splitter Tee				
Model	Description		Pinout (Male)	Pinout (Female)
CSB-M1250M1250-T	Female trunk, 1 female branch, 1 male branch			
			1 = Brown 2 = White 3 = Blue	4 = Black 5 = Green/Yellow

### Warnings

**Install and properly ground a qualified surge suppressor when installing a remote antenna system.** Remote antenna configurations installed without surge suppressors invalidate the manufacturer's warranty. Keep the ground wire as short as possible and make all ground connections to a single-point ground system to ensure no ground loops are created. No surge suppressor can absorb all lightning strikes; do not touch the Sure Cross® device or any equipment connected to the Sure Cross device during a thunderstorm.

**Exporting Sure Cross® Radios.** It is our intent to fully comply with all national and regional regulations regarding radio frequency emissions. **Customers who want to re-export this product to a country other than that to which it was sold must ensure the device is approved in the destination country.** The Sure Cross wireless products were certified for use in these countries using the antenna that ships with the product. When using other antennas, verify you are not exceeding the transmit power levels allowed by local governing agencies. This device has been designed to operate with the antennas listed on Banner Engineering's website and having a maximum gain of 9 dBm. Antennas not included in this list or having a gain greater than 9 dBm are strictly prohibited for use with this device. The required antenna impedance is 50 ohms. To reduce potential radio interference to other users, the antenna type and its gain should be so chosen such that the equivalent isotropically radiated power (EIRP) is not more than that permitted for successful communication. Consult with Banner Engineering Corp. if the destination country is not on this list.



**Important:** Please download the complete Sure Cross® MultiHop Data Radio technical documentation, available in multiple languages, from [www.bannerengineering.com](http://www.bannerengineering.com) for details on the proper use, applications, Warnings, and installation instructions of this device.



**Important:** Por favor descargue desde [www.bannerengineering.com](http://www.bannerengineering.com) toda la documentación técnica de los Sure Cross® MultiHop Data Radio, disponibles en múltiples idiomas, para detalles del uso adecuado, aplicaciones, advertencias, y las instrucciones de instalación de estos dispositivos.



**Important:** Veuillez télécharger la documentation technique complète des Sure Cross® MultiHop Data Radio sur notre site [www.bannerengineering.com](http://www.bannerengineering.com) pour les détails sur leur utilisation correcte, les applications, les notes de sécurité et les instructions de montage.



**WARNING:**

- **Do not use this device for personnel protection**
- Using this device for personnel protection could result in serious injury or death.
- This device does not include the self-checking redundant circuitry necessary to allow its use in personnel safety applications. A device failure or malfunction can cause either an energized (on) or de-energized (off) output condition.



**Important:**

- **Never operate a 1 Watt radio without connecting an antenna**
- Operating 1 Watt radios without an antenna connected will damage the radio circuitry.
- To avoid damaging the radio circuitry, never apply power to a Sure Cross® Performance or Sure Cross MultiHop (1 Watt) radio without an antenna connected.



**Important:**

- **Electrostatic discharge (ESD) sensitive device**
- ESD can damage the device. Damage from inappropriate handling is not covered by warranty.
- Use proper handling procedures to prevent ESD damage. Proper handling procedures include leaving devices in their anti-static packaging until ready for use; wearing anti-static wrist straps; and assembling units on a grounded, static-dissipative surface.

## Banner Engineering Corp. Limited Warranty

Banner Engineering Corp. warrants its products to be free from defects in material and workmanship for one year following the date of shipment. Banner Engineering Corp. will repair or replace, free of charge, any product of its manufacture which, at the time it is returned to the factory, is found to have been defective during the warranty period. This warranty does not cover damage or liability for misuse, abuse, or the improper application or installation of the Banner product.

**THIS LIMITED WARRANTY IS EXCLUSIVE AND IN LIEU OF ALL OTHER WARRANTIES WHETHER EXPRESS OR IMPLIED (INCLUDING, WITHOUT LIMITATION, ANY WARRANTY OF MERCHANTABILITY OR FITNESS FOR A PARTICULAR PURPOSE, AND WHETHER ARISING UNDER COURSE OF PERFORMANCE, COURSE OF DEALING OR TRADE USAGE.**

**This Warranty is exclusive and limited to repair or, at the discretion of Banner Engineering Corp., replacement. IN NO EVENT SHALL BANNER ENGINEERING CORP. BE LIABLE TO BUYER OR ANY OTHER PERSON OR ENTITY FOR ANY EXTRA COSTS, EXPENSES, LOSSES, LOSS OF PROFITS, OR ANY INCIDENTAL, CONSEQUENTIAL OR SPECIAL DAMAGES RESULTING FROM ANY PRODUCT DEFECT OR FROM THE USE OR INABILITY TO USE THE PRODUCT, WHETHER ARISING IN CONTRACT OR WARRANTY, STATUTE, TORT, STRICT LIABILITY, NEGLIGENCE, OR OTHERWISE.**

Banner Engineering Corp. reserves the right to change, modify or improve the design of the product without assuming any obligations or liabilities relating to any product previously manufactured by Banner Engineering Corp. Any misuse, abuse, or improper application or installation of this product or use of the product for personal protection applications when the product is identified as not intended for such purposes will void the product warranty. Any modifications to this product without prior express approval by Banner Engineering Corp will void the product warranties. All specifications published in this document are subject to change; Banner reserves the right to modify product specifications or update documentation at any time. Specifications and product information in English supersede that which is provided in any other language. For the most recent version of any documentation, refer to: [www.bannerengineering.com](http://www.bannerengineering.com).

For patent information, see [www.bannerengineering.com/patents](http://www.bannerengineering.com/patents).

## Notas Adicionales

Información México: La operación de este equipo está sujeta a las siguientes dos condiciones: 1) es posible que este equipo o dispositivo no cause interferencia perjudicial y 2) este equipo debe aceptar cualquier interferencia, incluyendo la que pueda causar su operación no deseada.

Banner es una marca registrada de Banner Engineering Corp. y podrán ser utilizadas de manera indistinta para referirse al fabricante. "Este equipo ha sido diseñado para operar con las antenas tipo Omnidireccional para una ganancia máxima de antena de 6 dBd y Yagi para una ganancia máxima de antena 10 dBd que en seguida se enlistan. También se incluyen aquellas con aprobación ATEX tipo Omnidireccional siempre que no excedan una ganancia máxima de antena de 6dBd. El uso con este equipo de antenas no incluidas en esta lista o que tengan una ganancia mayor que 6 dBd en tipo omnidireccional y 10 dBd en tipo Yagi, quedan prohibidas. La impedancia requerida de la antena es de 50 ohms."

Antenas SMA	Modelo	Antenas Tipo-N	Modelo
Antena, Omni 902-928 MHz, 2 dBd, junta de caucho, RP-SMA Macho	<b>BWA-902-C</b>	Antena, Omni 902-928 MHz, 6 dBd, fibra de vidrio, 1800mm, N Hembra	<b>BWA-906-A</b>
Antena, Omni 902-928 MHz, 5 dBd, junta de caucho, RP-SMA Macho	<b>BWA-905-C</b>	Antena, Yagi, 900 MHz, 10 dBd, N Hembra	<b>BWA-9Y10-A</b>

## Mexican Importer

Banner Engineering de México, S. de R.L. de C.V.  
David Alfaro Siqueiros 103 Piso 2 Valle oriente  
San Pedro Garza Garcia Nuevo León, C. P. 66269

81 8363.2714

## ANATEL

Modelo (Model): DX80-2400—Este equipamento não tem direito à proteção contra interferência prejudicial e não pode causar interferência em sistemas devidamente autorizados. Para maiores informações, consulte o site da ANATEL [www.gov.br/anatel/pt-br/](http://www.gov.br/anatel/pt-br/)

