

51863 ✓ ACTIVE



PIDG

TE Internal #: 51863

Ring Terminals & Spade Terminals, Ring Tongue, 22 – 16 AWG

Wire Size, .26 – 1.65 mm² Wire Size, 509 – 3260 CMA Wire Size,

Stud Size M3.5, PIDG

[View on TE.com >](#)

Terminals & Splices > Ring Terminals & Spade Terminals > PIDG Ring Tongue Terminals

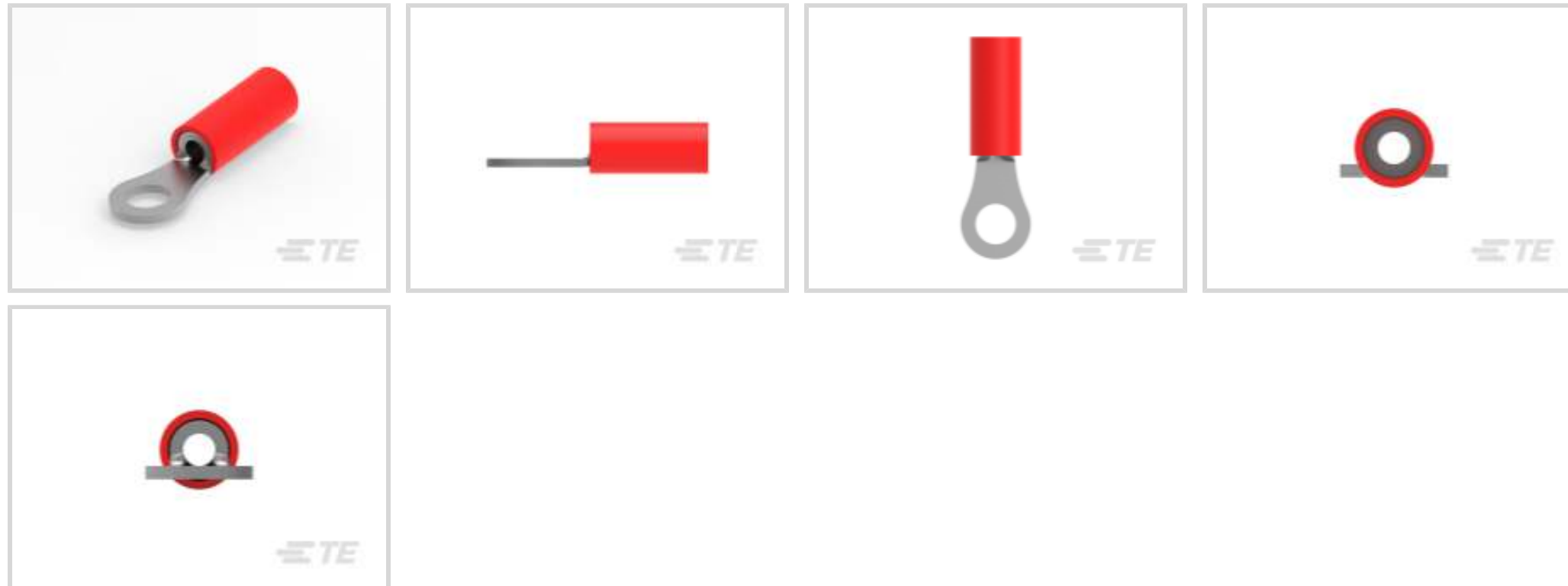

Ring & Spade Terminal Type: **Ring Tongue**

Wire Size: **509 – 3260 CMA**

Stud Size: **M3.5**

[All PIDG Ring Tongue Terminals \(421\)](#)

Features

Product Type Features

Stud Size	M3.5
Sealable	No
Wire Insulation Support Retention Type	Insulation Support

Configuration Features

Number of Holes	1
-----------------	---

Electrical Characteristics

Voltage Rating	300 V
----------------	-------

Body Features

Product Weight	.625 g
Insulation Sleeve Color	Red

Contact Features

Military Part Class	Class I
Ring & Spade Terminal Type	Ring Tongue



Barrel Type	Closed
Terminal Orientation	Straight
Terminal Plating Material	Tin

Mechanical Attachment

Wire Insulation Support	With
-------------------------	------

Dimensions

Wire Size	509 – 3260 CMA
Stud Diameter	3.68 mm[.145 in]
Tongue Thickness	.79 mm[.031 in]
Product Length	19.86 mm[.782 in]
Compatible Insulation Diameter (Max)	3.81 mm[.15 in]
Compatible Insulation Diameter Range	2.03 – 3.81 mm[.08 – .15 in]

Usage Conditions

Insulation Option	Partially Insulated
Operating Temperature Range	105 °C[221 °F]

Operation/Application

Compatible With Wire Base Material	Copper
Compatible With Wire Plating Material	Tin

Industry Standards

Government Qualified Terminal	Yes
-------------------------------	-----

Packaging Features

Packaging Quantity	1000
Packaging Method	Loose Piece

Product Compliance

[For compliance documentation, visit the product page on TE.com>](#)

EU RoHS Directive 2011/65/EU	Compliant
EU ELV Directive 2000/53/EC	Compliant
China RoHS 2 Directive MIIT Order No 32, 2016	No Restricted Materials Above Threshold
EU REACH Regulation (EC) No. 1907/2006	Current ECHA Candidate List: JUNE 2023 (235) Candidate List Declared Against: JUNE 2023 (235)

Does not contain REACH SVHC

Halogen Content

Low Halogen - Br, Cl, F, I < 900 ppm per homogenous material. Also BFR/CFR/PVC Free

Solder Process Capability

Not applicable for solder process capability

Product Compliance Disclaimer

This information is provided based on reasonable inquiry of our suppliers and represents our current actual knowledge based on the information they provided. This information is subject to change. The part numbers that TE has identified as EU RoHS compliant have a maximum concentration of 0.1% by weight in homogenous materials for lead, hexavalent chromium, mercury, PBB, PBDE, DBP, BBP, DEHP, DIBP, and 0.01% for cadmium, or qualify for an exemption to these limits as defined in the Annexes of Directive 2011/65/EU (RoHS2). Finished electrical and electronic equipment products will be CE marked as required by Directive 2011/65/EU. Components may not be CE marked. Additionally, the part numbers that TE has identified as EU ELV compliant have a maximum concentration of 0.1% by weight in homogenous materials for lead, hexavalent chromium, and mercury, and 0.01% for cadmium, or qualify for an exemption to these limits as defined in the Annexes of Directive 2000/53/EC (ELV). Regarding the REACH Regulation, the information TE provides on SVHC in articles for this part number is based on the latest European Chemicals Agency (ECHA) 'Guidance on requirements for substances in articles' posted at this URL: <https://echa.europa.eu/guidance-documents/guidance-on-reach>

Compatible Parts



REPRESENTATION ONLY

TE Part # 47386
DAHT PG PIDG 26-16 ASSY



REPRESENTATION ONLY

TE Part # 47386-4
DAHT PG PIDG 26-16 ASSY



TE Part # 58433-3
PRO CR ASSY, RBY IS9252



TE Part # 59250
T-HEAD PIDG 26-14 ASSY



TE Part # 58423-1
DIE, RBY IS9252



TE Part # 59824-1
TETRA-CRIMP PIDG PG FASTON 22-10 ASSY



REPRESENTATION ONLY

TE Part # 525690
DAHT PG PIDG 20-18 ASSY



TE Part # 539691-2
ERGO DIE R.B.Y



TE Part # 2063030-1
SDE DIESET, RBY, UL



TE Part # 47806-2
DIES PIDG 22-16 DIE SET



TE Part # 59300
T-HEAD PIDG PG 26-16 ASSY



TE Part # 69344
PIDG 26-22 DIE SET

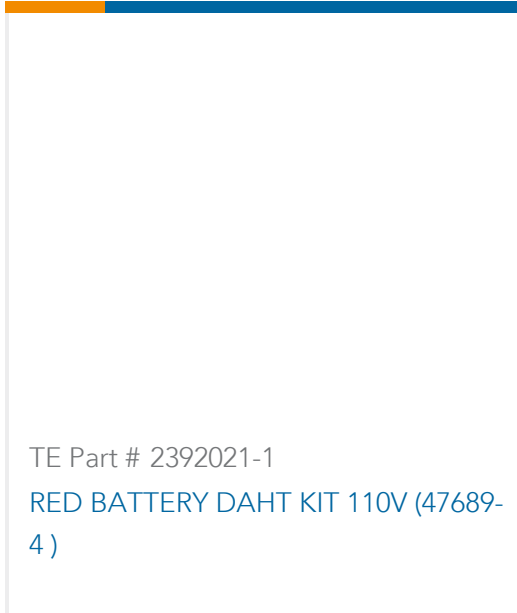
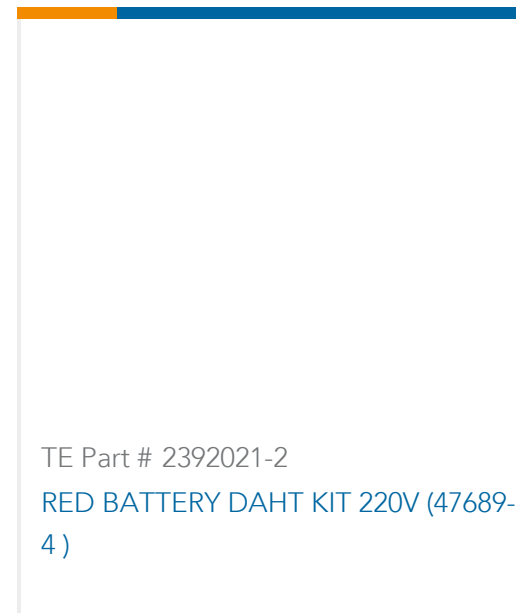

Also in the Series | PIDG

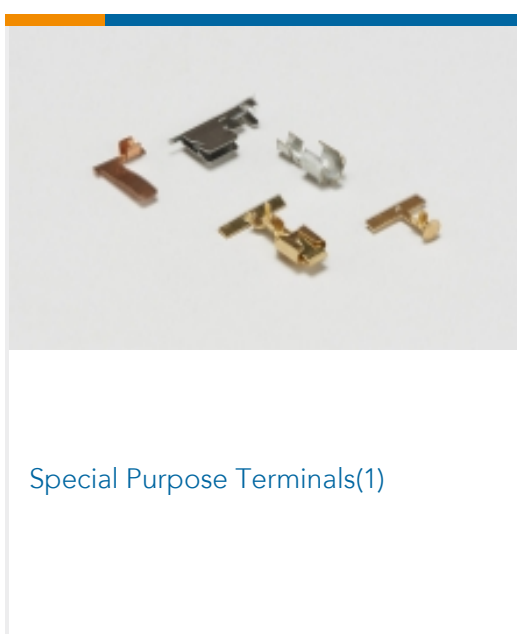
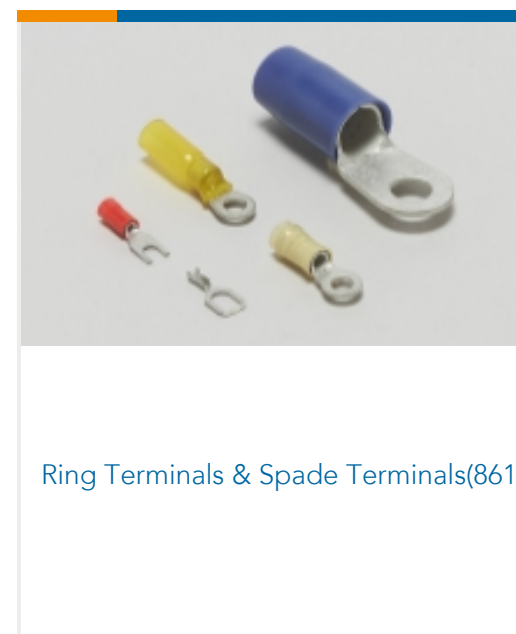
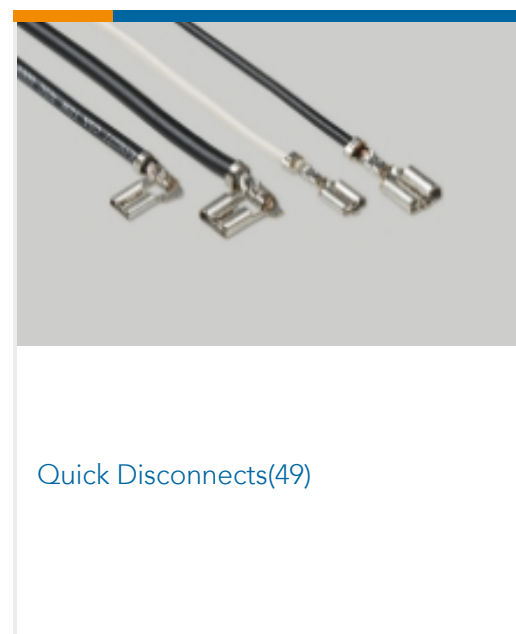
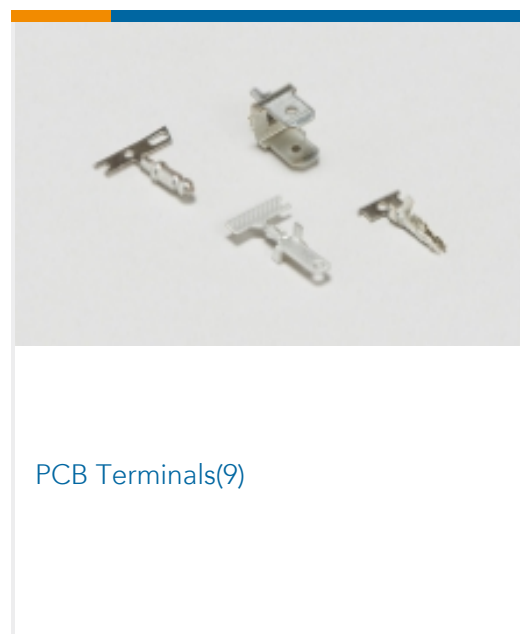
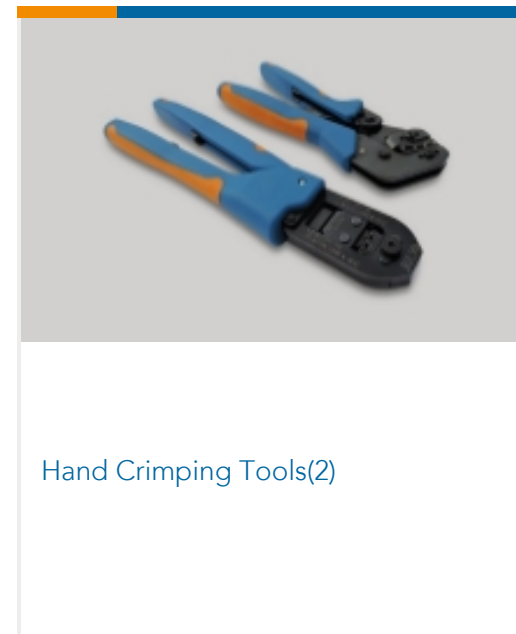
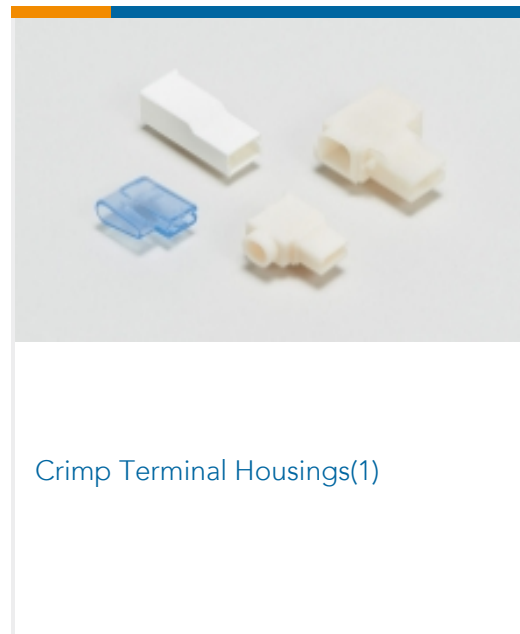
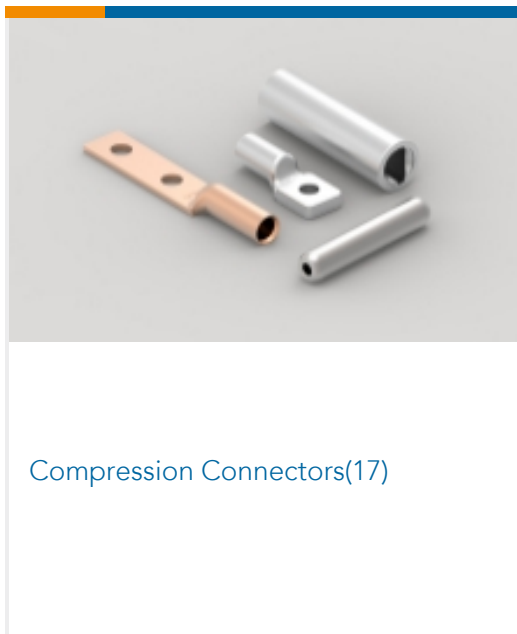

Customers Also Bought

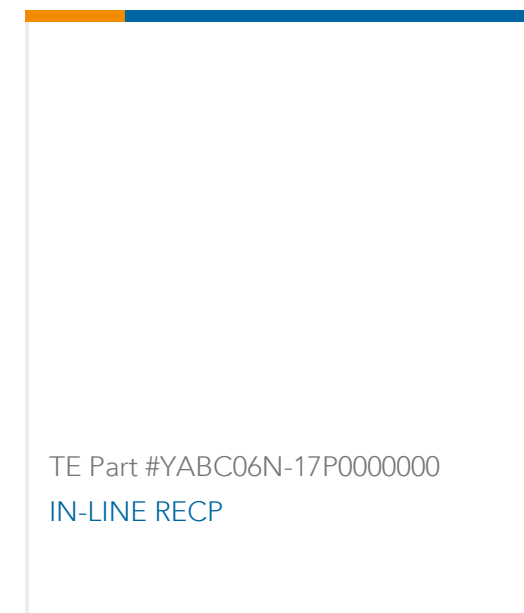
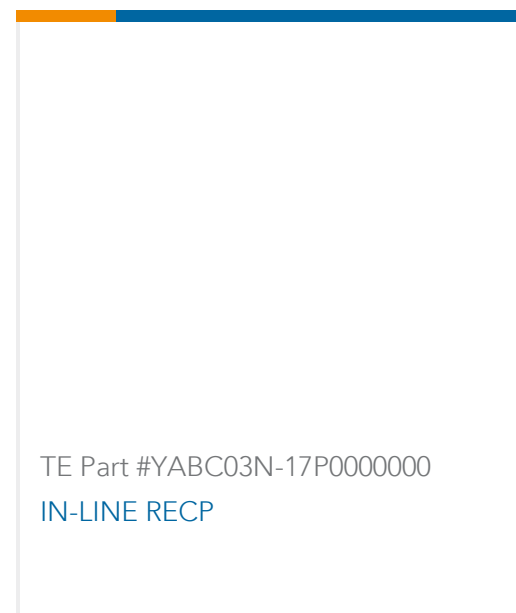
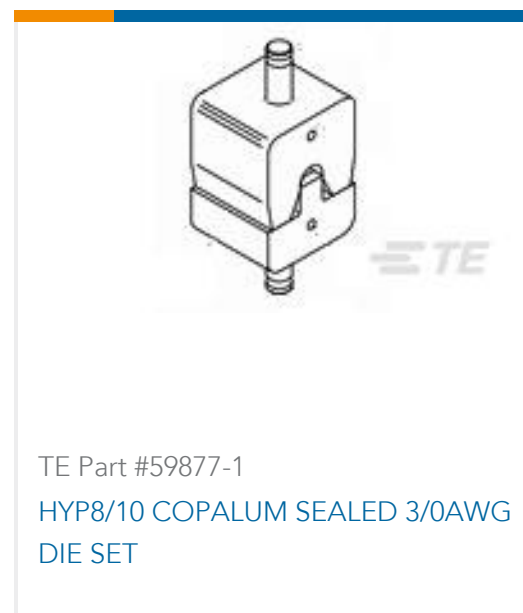
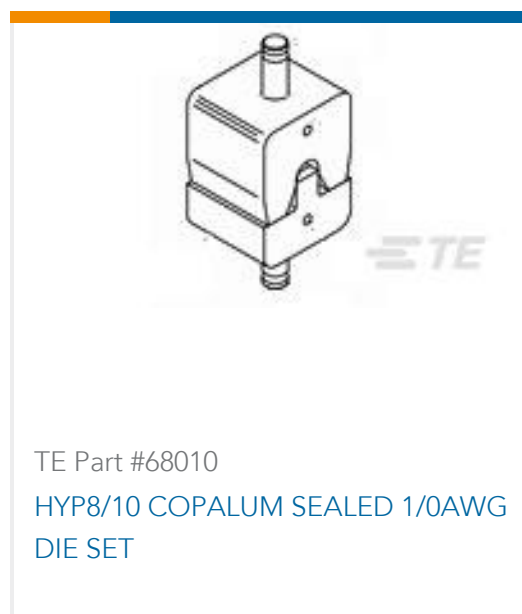

Documents

Product Drawings

TERM, R, PIDG, 22-16/22-18, #6(M3.5)

English

CAD Files

3D PDF

3D

Customer View Model

[ENG_CVM_CVM_51863_AC.2d_dxf.zip](#)

English

Customer View Model

[ENG_CVM_CVM_51863_AC.3d_igs.zip](#)

English

Customer View Model

[ENG_CVM_CVM_51863_AC.3d_stp.zip](#)

English

By downloading the CAD file I accept and agree to the [Terms and Conditions](#) of use.

Datasheets & Catalog Pages

[PIDG TERMINALS & SPLICES Quick Reference Guide](#)

English

Product Specifications

[Application Specification](#)

English

Product Environmental Compliance

[MD_51863_080120161010_dmtec](#)

51863

Ring Terminals & Spade Terminals, Ring Tongue, 22 – 16 AWG Wire Size, .26 – 1.65 mm² Wire Size, 509 – 3260 CMA Wire Size, Stud Size M3.5, PIDG



English

[MD_51863_080120161010_dmtec](#)

English

[Agency Approvals](#)

[UL Report](#)

English