

<b>Order Code</b>	<b>TCK-118</b>
<b>Inductance</b> (each winding)	175 $\mu$ H $\pm$ 25% (at 10 kHz / 50 mV)
<b>Impedance</b> (DCR)	34 m $\Omega$ max.
<b>Rated Current</b>	1.76 A max.
<b>Rated Voltage</b>	500 VDC max. (between windings)
<b>Operating Temperature</b>	-40°C to +105°C
<b>RoHS Exemptions</b>	No Exemptions

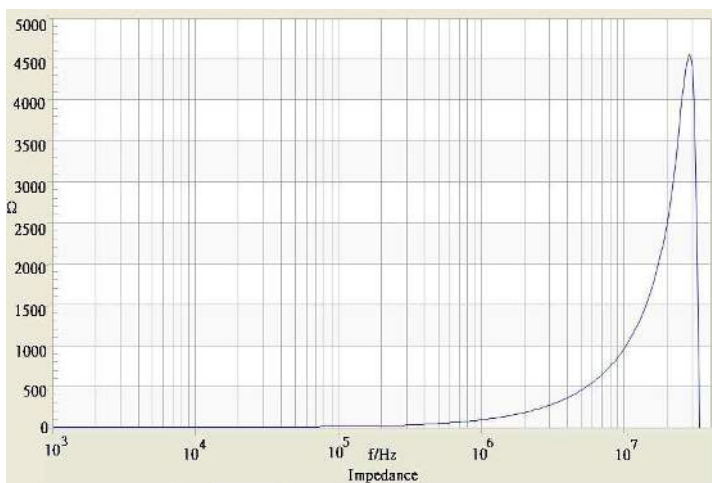

### Impedance Curve



### Outline Dimensions

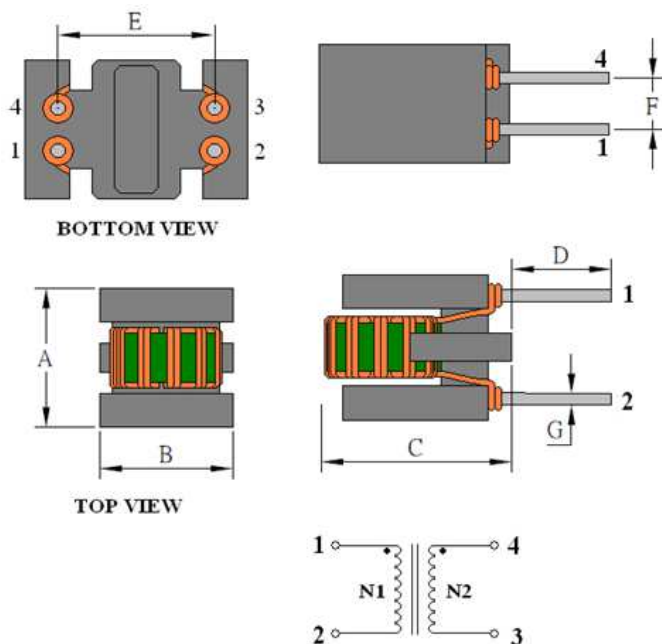

Dimensions [mm]	
<b>A</b>	7.5 max.
<b>B</b>	8.5 max.
<b>C</b>	10.5 max.
<b>D</b>	3.5 $\pm$ 1.0
<b>E</b>	5.08 $\pm$ 0.5
<b>F</b>	2.54 $\pm$ 0.3
<b>G</b>	$\varnothing$ 0.6 $\pm$ 0.1

All specifications valid at +25°C, unless otherwise stated.