

700 mA non-isolated high-voltage buck evaluation board using ICE5BR2280BZ

EVAL_5BR2280BZ_700mA1

About this document



Scope and purpose

This document is an engineering report that describes a non-isolated 15 V, 700 mA high-voltage (HV) buck converter using the latest fifth-generation Infineon fixed-frequency (FF) CoolSET™ ICE5BR2280BZ. The document contains power supply specifications, schematics, bill of materials (BOM), PCB layout and performance data. This evaluation board is designed for users who wish to evaluate the performance of ICE5BR2280BZ and its ease of use.

Intended audience

This document is intended for SMPS design/application engineers, students, etc., who wish to design low-cost and non-isolated buck converters for applications such as auxiliary power supplies for white goods, smart metering, etc.

Table of contents

About this document	1
Table of contents	1
1 Abstract	3
2 Evaluation board	4
3 Specifications of evaluation board	5
4 Circuit diagram	6
5 Circuit description	7
5.1 Line input.....	7
5.2 Start-up.....	7
5.3 Integrated MOSFET and PWM control	7
5.4 Output stage.....	7
5.5 Feedback control.....	7
5.6 Primary-side peak-current control.....	7
5.7 Frequency reduction	7
5.8 Active burst mode	8
5.9 Protection features	8
6 PCB layout	9
6.1 Top side	9
6.2 Bottom side	9
7 Bill of materials	10
8 Test results	12
8.1 Efficiency.....	12
8.2 Standby power	13
8.3 Line and load regulation	13

Table of contents

8.4	Surge immunity (EN 61000-4-5)	14
8.5	Conducted emissions (EN 55022 class B)	14
8.6	Thermal measurement	15
9	Waveforms and scope plots	16
9.1	Start-up with maximum load	16
9.2	Soft-start.....	16
9.3	Drain voltage and current at maximum load	17
9.4	Output ripple voltage at maximum load	17
9.5	ABM operation	18
9.6	Overload protection (odd-skip auto-restart)	18
9.7	Output short test.....	19
10	Design example A	20
10.1	Specification of design example A.....	20
10.2	Full-load efficiency	20
11	References	21
	Revision history	22

1 Abstract

This engineering report describes a 15 V, 700 mA evaluation board designed in a buck converter topology using the fifth-generation FF CoolSET™ ICE5BR2280BZ. The target applications of ICE5BR2280BZ are either auxiliary power supplies for white goods, PCs, servers or TVs, or enclosed adapters for Blu-ray players, set-top boxes, games consoles, smart metering, etc. The 800 V CoolMOS™ integrated into this IC greatly simplifies the design and layout of the PCB. The new improved digital frequency reduction and frequency jitter feature offer lower EMI and higher efficiency. The enhanced active burst mode (ABM) power enables flexibility in standby power operation range selection. In addition, numerous adjustable protection functions have been implemented in ICE5BR2280BZ to protect the system and customize the IC for the chosen application.

2 Evaluation board

This document contains the list of features, the power-supply specifications, schematics, BOM and performance data. Typical operating characteristics such as performance curve and scope waveforms are shown at the end of the report.

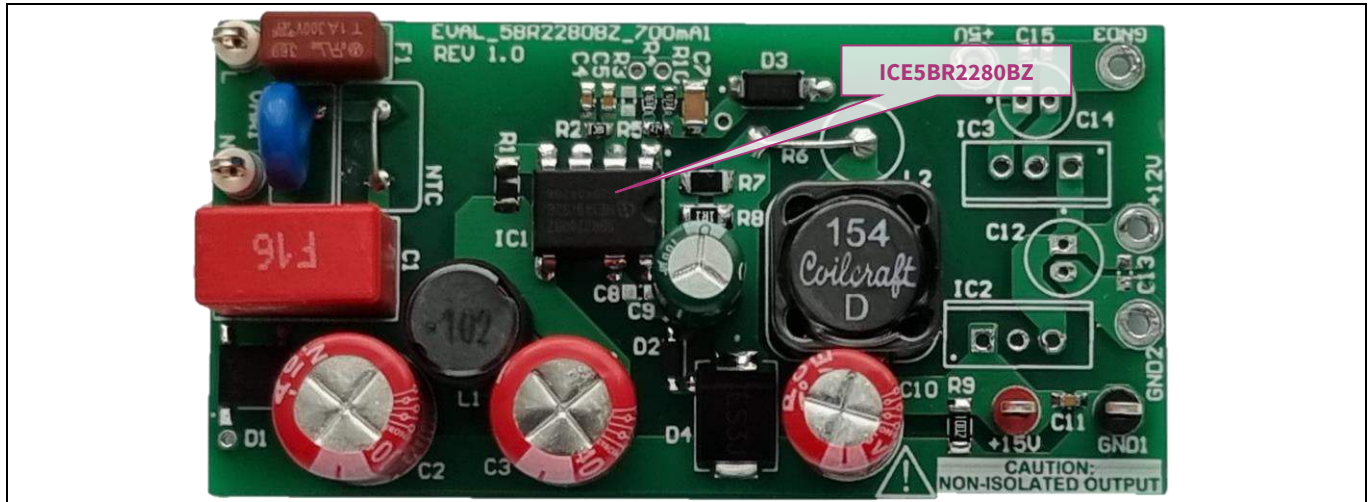

Figure 1 EVAL_5BR2280BZ_700mA1

3 Specifications of evaluation board

Table 1 Specifications of EVAL_5BR2280BZ_700mA1

Description	Symbol	Min.	Typ.	Max.	Units	Comments
Input						
Voltage	V_{IN}	85		264	V AC	2-wire (no P.E.)
Frequency	f_{LINE}	47	50/60	63	Hz	
Output						
Voltage	V_{OUT}		15		V	
Current	I_{OUT}		0.7		A	
Output power	P_{OUT}		10.5		W	
Output voltage accuracy			< ±5%		%	
Over current protection			< 150% of rated current		A	
Ripple and noise voltage	V_{pk-pk}		< 1% (20 MHz bandwidth)		mV	With 10 µF e-cap and 0.1 µF MLCC
Environmental						
Conducted EMI			6		dB	Margin, CISPR 22 class B EN 61000-4-5
Surge immunity						
Differential mode (DM)			± 1		kV	
Ambient temperature	T_{amb}	-20	-	50	°C	Free convection, sea level
PCB form factor			70 × 35		mm	L × W

Note: The table above represents the minimum acceptable performance of the design; actual measurement results are given in the test results section. This evaluation board is designed to demonstrate the maximum output current only.

Circuit diagram

4 Circuit diagram

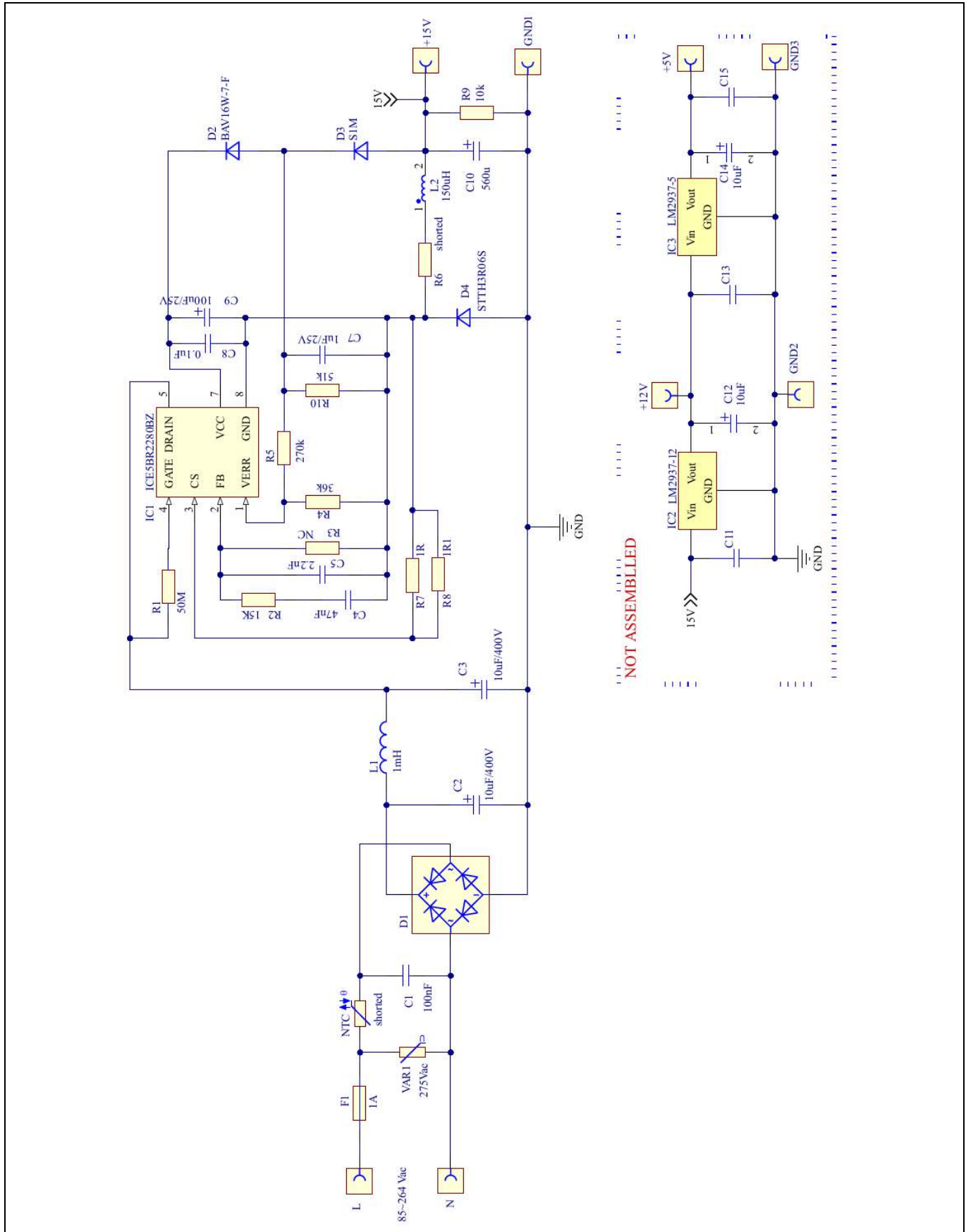

Figure 2 Schematic of EVAL_5BR2280BZ_700mA1

5 Circuit description

5.1 Line input

The AC-line input stage comprises the input fuse F1, varistor VAR1, X-capacitor C1, rectifier diode bridge D1, capacitors C2 and C3, and inductor L1. The X-capacitor C1 and π -filter C2, L1 and C3 act as EMI suppressors.

5.2 Start-up

ICE5BR2280BZ uses a cascode structure to fast-charge the V_{CC} capacitor. Pull-up resistor R1 connected to the GATE pin (pin 4) is used to initiate the start-up phase. When V_{VCC} reaches the turn-on voltage threshold 16 V, the IC begins with a soft-start. The soft-start implemented in ICE5BR2280BZ is a digital time-based function. The preset soft-start time is 12 ms with four steps. If not limited by other functions, the peak voltage on the CS pin will increase in increments from 0.3 V to 1 V. After IC turn-on, the V_{CC} voltage is supplied by output voltage. V_{CC} short-to-GND protection is implemented during the start-up time.

5.3 Integrated MOSFET and PWM control

ICE5BR2280BZ is comprised of a power MOSFET and the controller, which simplifies the circuit layout and reduces the cost of PCB manufacture. The controller together with the MOSFET is placed at the high-side of the converter with a floating ground at the cathode of freewheeling diode D4. An ultra-fast recovery diode D4 is used to allow the inductor demagnetizing current to flow through it and limit the spike current through the power MOSFET, especially when the buck converter operates in CCM mode. Thus, output voltage is sensed only during freewheeling diode conduction time.

5.4 Output stage

The maximum output voltage ripple is determined by the output capacitance and the equivalent series resistance (ESR) of the output capacitor. Selection of a low-ESR capacitor helps to reduce ripple. The dummy load resistor R9 helps output voltage regulation at light-load condition.

5.5 Feedback control

ICE5BR2280BZ integrates a transconductance amplifier for feedback (FB) control. The output is sensed by the voltage divider (R4 and R5) and compared with an internal reference voltage at the VERR pin. An external compensation network (C4, C5 and R2) is recommended on the FB pin to control output voltage.

5.6 Primary-side peak-current control

The MOSFET drain-source current is sensed via external resistors R7 and R8. ICE5BR2280BZ is a current mode controller and has a cycle-by-cycle primary current and FB voltage control, which ensures the converter's maximum power is controlled in every switching cycle. To avoid mis-triggering caused by MOSFET switch-on transient voltage spikes, a leading-edge blanking (LEB) time (t_{CS_LEB}) is integrated in the current sensing (CS) path.

5.7 Frequency reduction

Frequency reduction is implemented in ICE5BR2280BZ to achieve better efficiency at light load. At light load, the reduced switching frequency F_{SW} improves efficiency by reducing the switching losses. When load decreases, V_{FB} and F_{SW} decrease. Typically, F_{SW} at high load is 65 kHz and starts to decrease at $V_{FB} = 1.7$ V. There is no further frequency reduction once it reaches the f_{OSC_MIN} even if the load is further reduced.

5.8 Active burst mode

ABM entry and exit power (two levels) can be selected in ICE5BR2280BZ. Details are illustrated in the product datasheet. ABM power level 1 is used in this evaluation board (R3 = open).

5.9 Protection features

ICE5BR2280BZ provides comprehensive protections to ensure safe system operation. This includes V_{CC} overvoltage (OV) and undervoltage (UV), overload, output OV, overtemperature (controller junction) and V_{CC} short-to-GND. When those faults are found, the system will enter protection mode. Once the fault is removed, the system resumes normal operation.

To protect ICE5BR2280BZ from excess thermal stress during auto-restart protection, a 100 μ F V_{CC} capacitor C9 is used to extend the total auto-restart off-time to around 4 s, as shown in Figure 17.

PCB layout

6 PCB layout

6.1 Top side

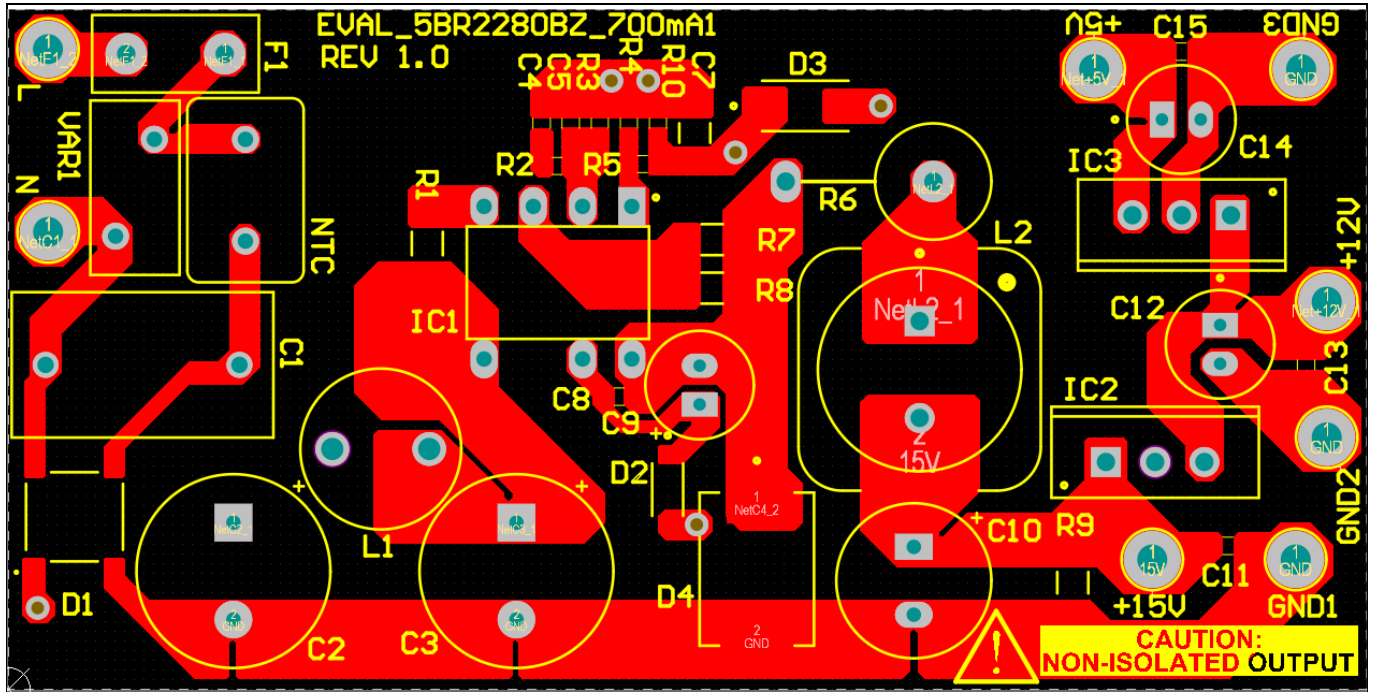

Figure 3 Top-side copper and component legend

6.2 Bottom side

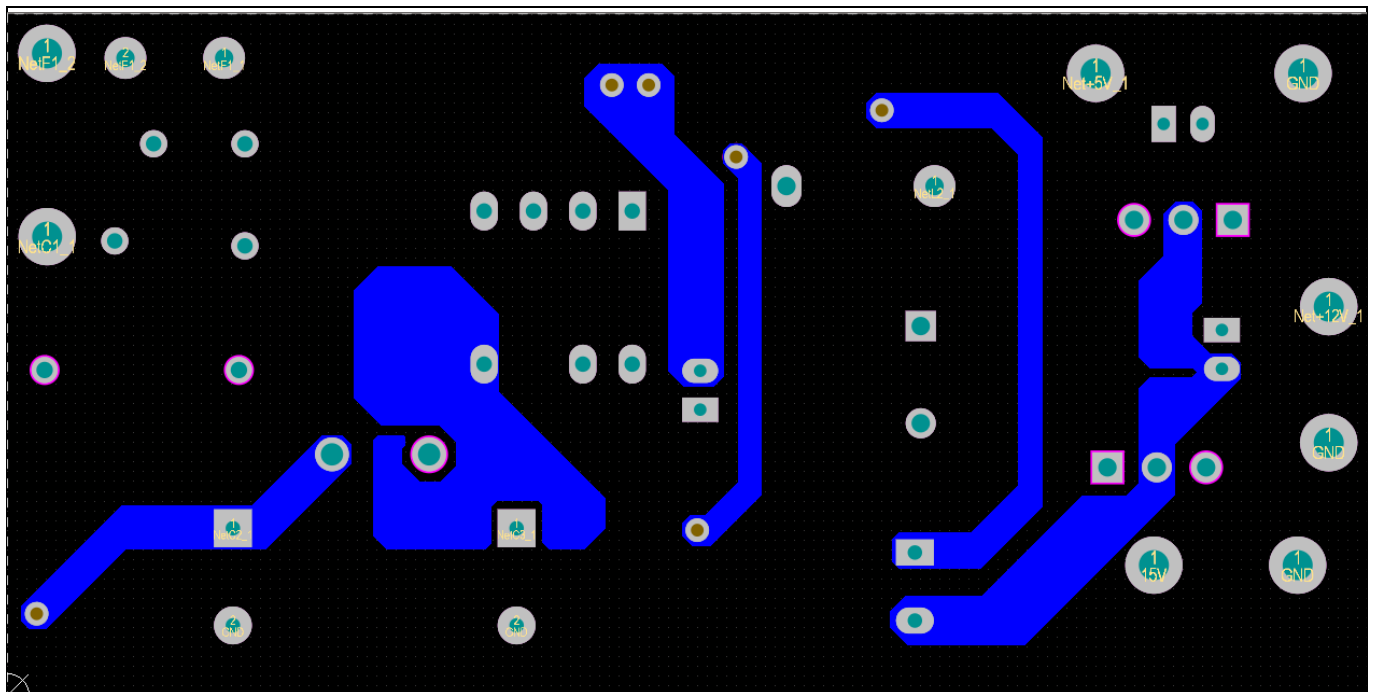

Figure 4 Bottom-side copper

Bill of materials

7 Bill of materials

Table 2 BOM

No.	Designator	Description	Part number	Manufacturer	Quantity
1	C1	Film capacitor 0.1 μ F 10% 310 V AC radial	890334023023	Würth Elektronik	1
2	C2, C3	Aluminum capacitor 10 μ F 20% 450 V radial	450BXF10M10X16	Rubycon	2
3	C4	Ceramic capacitor 47 nF 25 V X7R 0603			1
4	C5	Ceramic capacitor 2.2 nF 25 V X7R 0603			1
5	C7	Ceramic capacitor 1 μ F 25 V X7R 1206			1
6	C8	Ceramic capacitor 0.1 μ F 50 V X7R 0603			Open
7	C9	Aluminum capacitor 100 μ F 20% 50 V radial			1
8	C10	Aluminum capacitor 560 μ F 20% 25 V radial	860160474023	Würth Elektronik	1
9	C11, C13, C15	Ceramic capacitor 0.1 μ F 50 V X7R 0603			Open
10	C12, C14	Aluminum capacitor 10 μ F 20% 50 V radial	50PX10MEFC5X11	Rubycon	Open
11	D1	Bridge rectifier 1-phase 1 kV 1 A 4SOPA	ABS10A-13	Diodes Incorporated	1
12	D2	General-purpose diode 100 V 150 mA SOD-123	BAV16W-7-F	Diodes Incorporated	1
13	D3	General-purpose diode 1 kV 1 A SMA DO-214AC	S1M		1
14	D4	Surface-mount ultra-fast power rectifier	STTH3R06S		1
15	F1	Fuse board MNT 1 A 300 V AC radial			1
16	IC1	Gen5 FF CoolSET™ DIP-7	ICE5BR2280BZ	Infineon Technologies	1
17	IC2	IC linear regulator 12 V 1.5 A TO-220AB	L7812CV		Open
18	IC3	IC linear regulator 5 V 1.5 A TO-220AB	L7805CV		Open
19	L1	Fixed inductor 1000 μ H 0.6 A 1.27 Ω	7447452102	Würth Elektronik	1
20	L2	Fixed inductor 150 μ H 2.5 A	MSS1210-154KED	Coilcraft	1

700 mA non-isolated high-voltage buck evaluation board using ICE5BR2280BZ



Bill of materials

21	NTC	ICL 5 Ω 20% 4.2 A 9.5 mm	B57235S0509M000	TDK	Short
22	R1	Resistor 50 m Ω 300 mW 1206	CRHA1206AF50M0FKE F		1
23	R2	SMD resistor 15 k Ω 1% 1/10 W 0603			1
24	R4	SMD resistor 36 k Ω 1% 1/10 W 0603			1
25	R5	SMD resistor 270 k Ω 1% 1/10 W 0603			1
26	R6	Resistor 2 Ω 3 W TH	MCKNP03UJ020JB00		Short
27	R7	SMD resistor 1 Ω 1% 1/2 W 1206			1
28	R8	SMD resistor 1.1 Ω 1% 1/2 W 1206			1
29	R9	SMD resistor 10K Ω 1% 1/4 W 1206			1
30	R10	SMD resistor 51 k Ω 1% 1/10 W 0603			1
31	VAR1	S07K275E2 275 V AC 10%	B72207S2271K101	Epcos	1
32	Line, neutral	PC test point multipurpose THT, white	5012	Keystone	2
33	GND1, GND2, GND3	PC test point multipurpose THT, black	5011	Keystone	3
34	+5 V, +12 V, +15 V	PC test point multipurpose THT, red	5010	Keystone	3

Test results

8 Test results

8.1 Efficiency

Table 3 Efficiency

Input (V AC/Hz)	Load percentage (%)	P _{IN} (W)	V _{OUT} (V DC)	I _{OUT} (A)	P _{OUT} (W)	Efficiency η (%)	Average η (%)
85 V AC/60 Hz	No load	0.062	16.500	0.000			82.75%
	25	3.225	15.175	0.175	2.65	82.25%	
	50	6.368	15.108	0.350	5.28	82.99%	
	75	9.512	15.074	0.525	7.91	83.12%	
	100	12.742	15.051	0.700	10.53	82.63%	
115 V AC/60 Hz	No load	0.063	16.500	0.000			82.69%
	25	3.242	15.188	0.175	2.65	81.89%	
	50	6.386	15.120	0.350	5.29	82.82%	
	75	9.513	15.087	0.525	7.91	83.18%	
	100	12.704	15.051	0.700	10.53	82.87%	
230 V AC/50 Hz	No load	0.066	16.600	0.000			81.09%
	25	3.328	15.178	0.175	2.65	79.72%	
	50	6.528	15.120	0.350	5.29	81.02%	
	75	9.682	15.095	0.525	7.92	81.77%	
	100	12.865	15.055	0.700	10.53	81.86%	
264 V AC/50 Hz	No load	0.069	16.700	0.000			80.54%
	25	3.355	15.170	0.175	2.65	79.04%	
	50	6.574	15.115	0.350	5.29	80.43%	
	75	9.742	15.088	0.525	7.91	81.23%	
	100	12.931	15.057	0.700	10.53	81.45%	

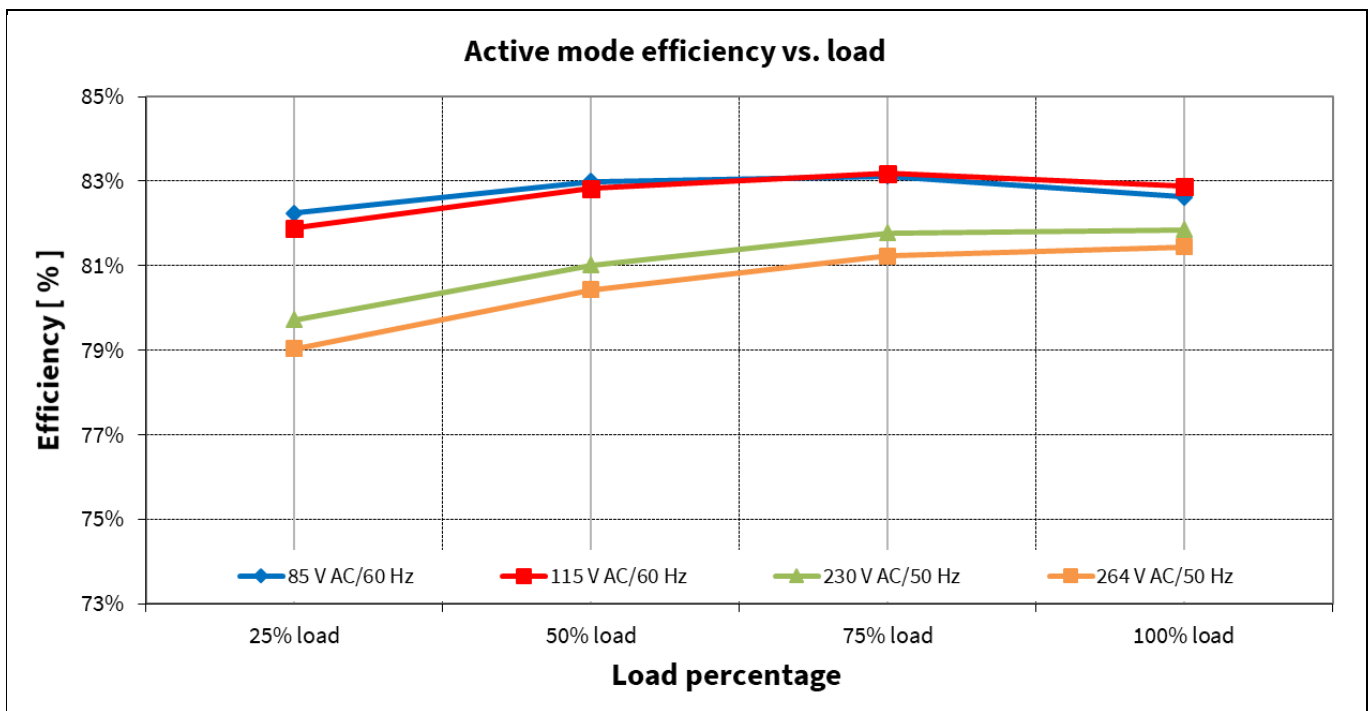

Figure 5 Efficiency vs. AC-line input voltage

Test results

8.2 Standby power

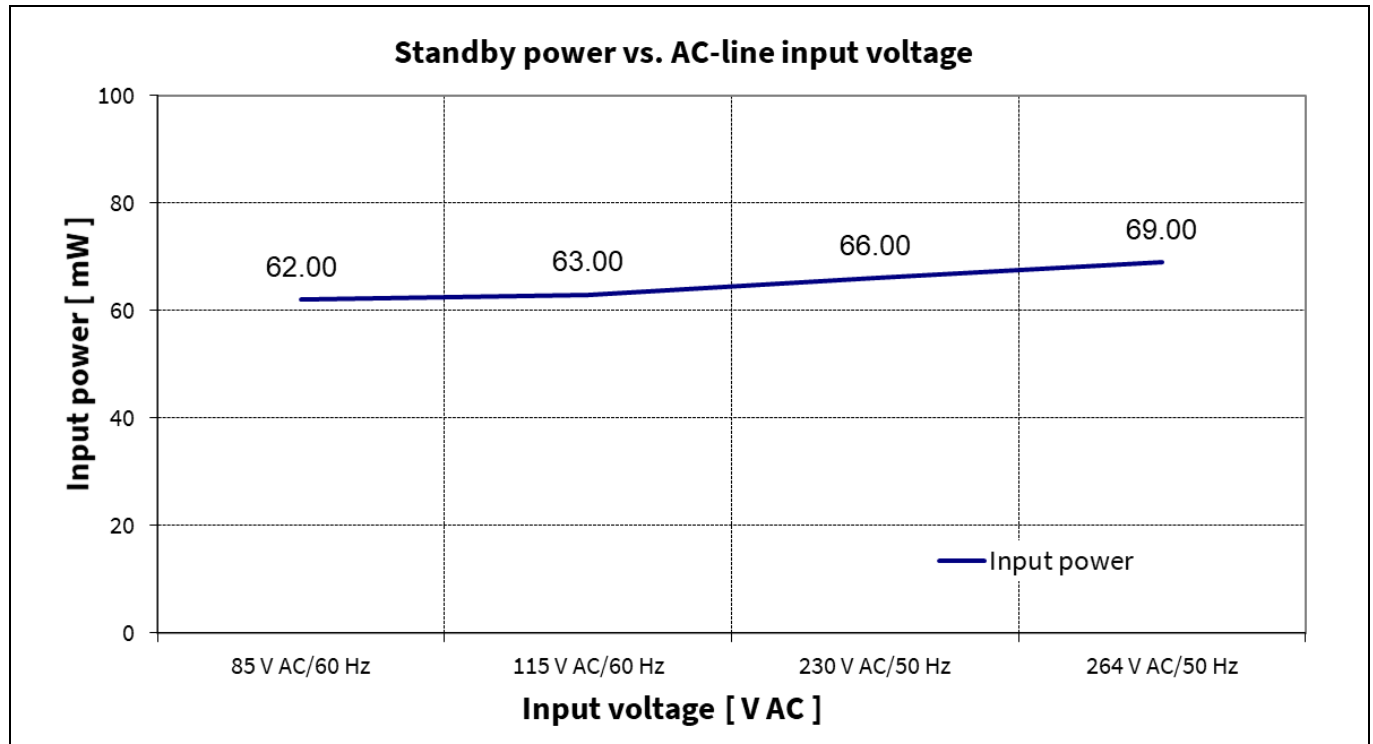

Figure 6 Standby power at 10 kΩ R9 (22 mW) vs. AC-line input voltage. Bleeder resistor R9 prevents output voltage to increase during no load

8.3 Line and load regulation

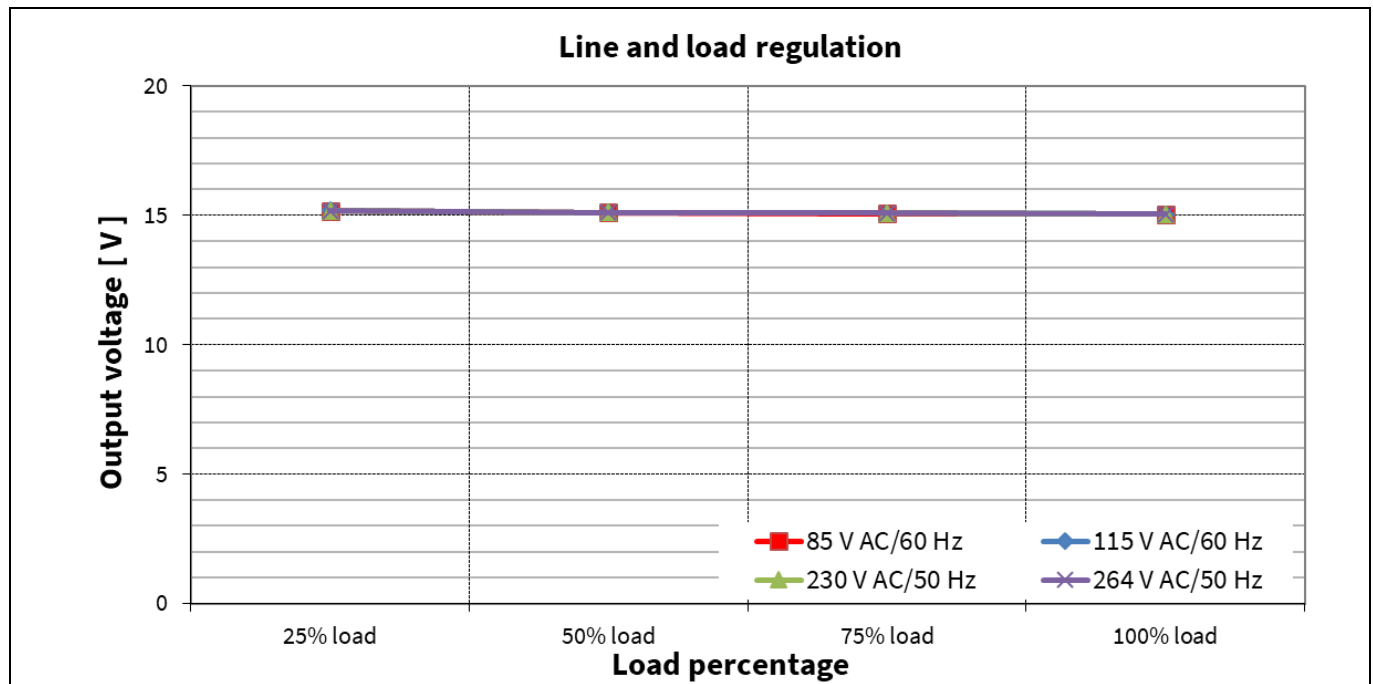

Figure 7 Line and load regulation

Test results

8.4 Surge immunity (EN 61000-4-5)

EN 61000-4-5 installation class 3 (± 1 kV for line-to-line DM). A test failure is defined as a non-recoverable and/or system auto-restart.

Table 4 Surge immunity test result

Description	Test	Level		Number of strikes				Test result
				0°	90°	180°	270°	
115/230 V AC, 700 mA	DM	+/- 1 kV	L → N	3	3	3	3	Pass

8.5 Conducted emissions (EN 55022 class B)

Conducted EMI was measured by Schaffner (SMR4503) and followed the test standard of EN 55022 (CISPR 22) class B. The evaluation board was connected to resistive load (700 mA) with input voltage of 115 V AC and 230 V AC.

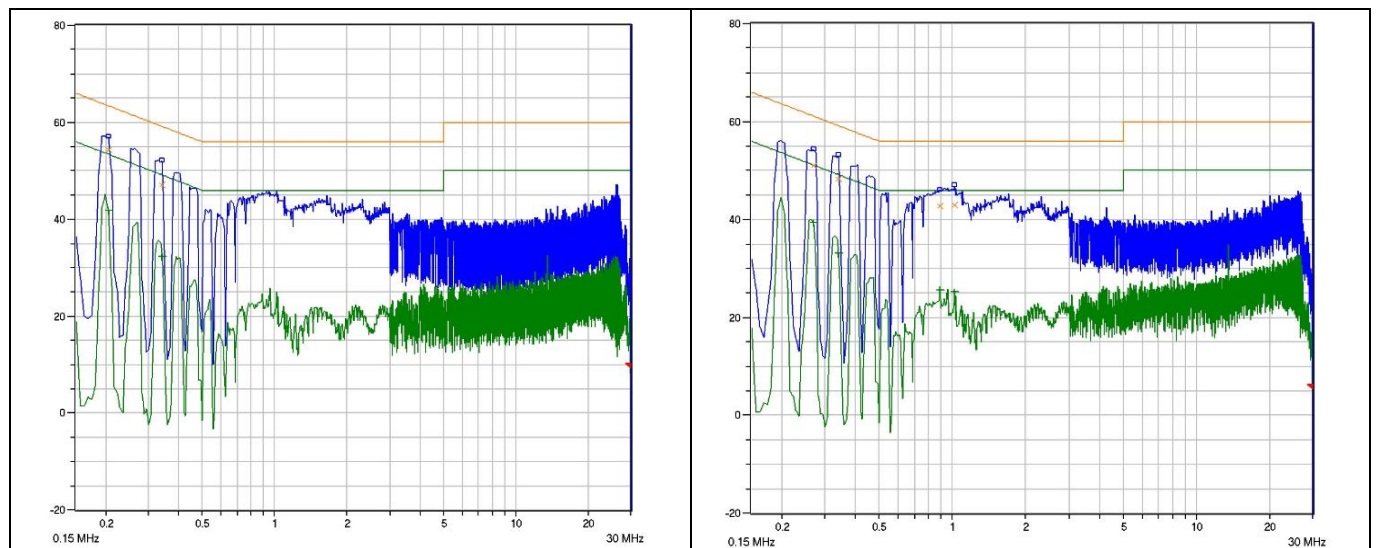

Passed with 6 dB margin for quasi-peak measurement at low-line (115 V AC).

Figure 8 Conducted emissions at 115 V AC with full load

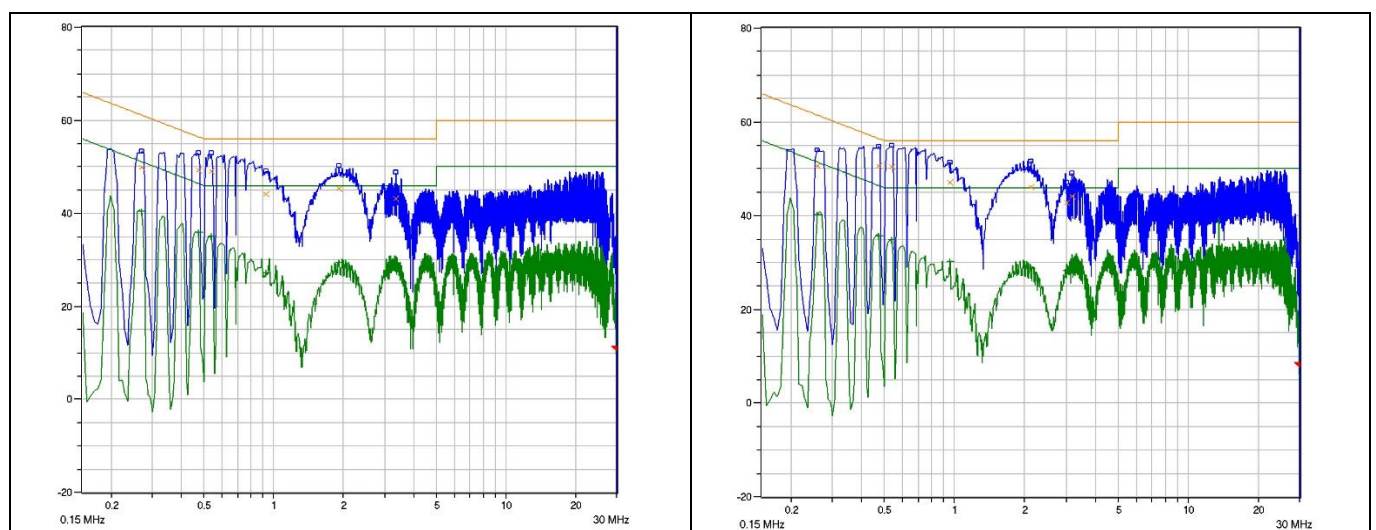

Passed with 6 dB margin for quasi-peak measurement at high-line (230 V AC).

Figure 9 Conducted emissions at 230 V AC with full load

Test results

8.6 Thermal measurement

The thermal test of the open-frame evaluation board was done using an infrared thermography camera (FLIR-T62101) at an ambient temperature of 25°C. The measurements were taken after one hour running at full load.

Table 5 Hottest temperature of evaluation board

No.	Major component	85 V AC (°C)	264 V AC (°C)
1	D4 (buck diode)	77.5	81.9
2	L2 (buck inductor)	73.2	96.2
3	IC1 (ICE5BR2280BZ)	70.5	68.3

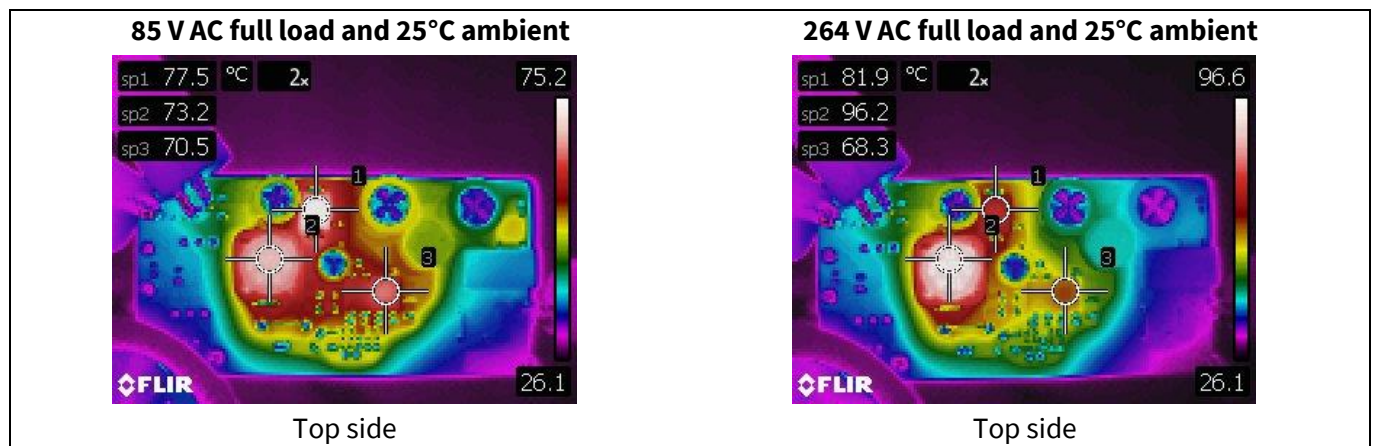

Figure 10 Infrared thermal image of EVAL_5BR2280BZ_700mA1

Waveforms and scope plots

9 Waveforms and scope plots

All waveforms and scope plots were recorded with a Teledyne LeCroy 8054 oscilloscope.

9.1 Start-up with maximum load

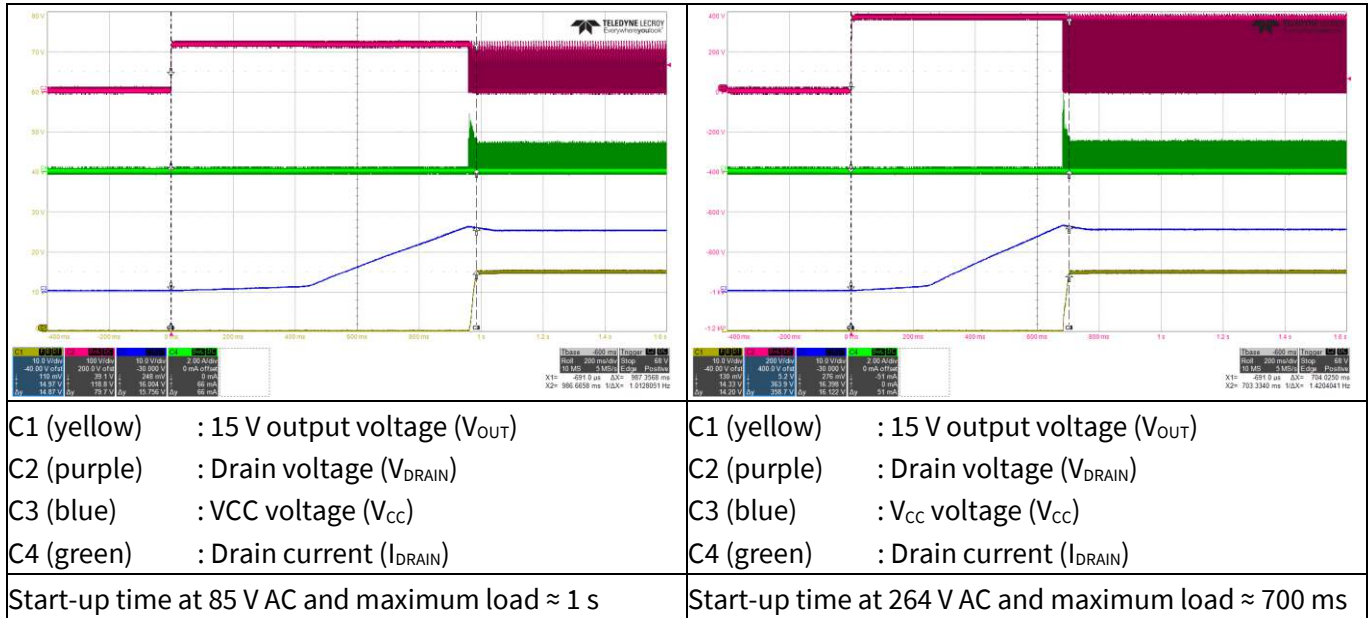

Figure 11 Start-up

9.2 Soft-start

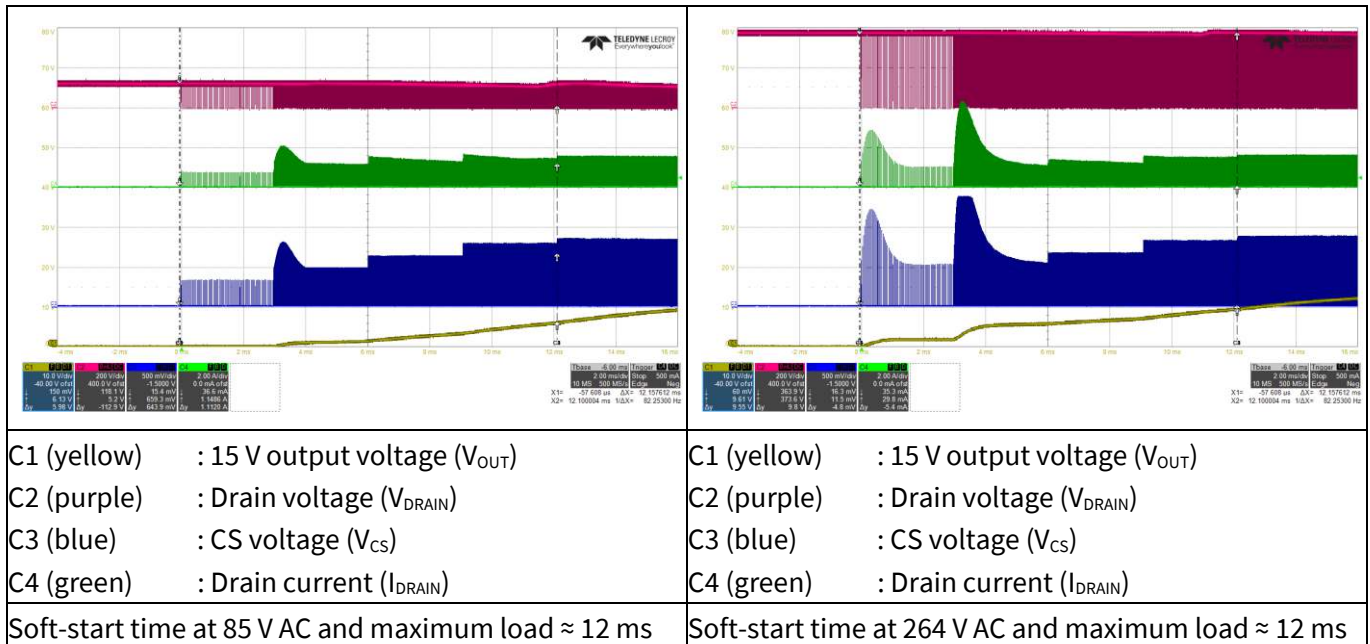

Figure 12 Soft-start

Waveforms and scope plots

9.3 Drain voltage and current at maximum load

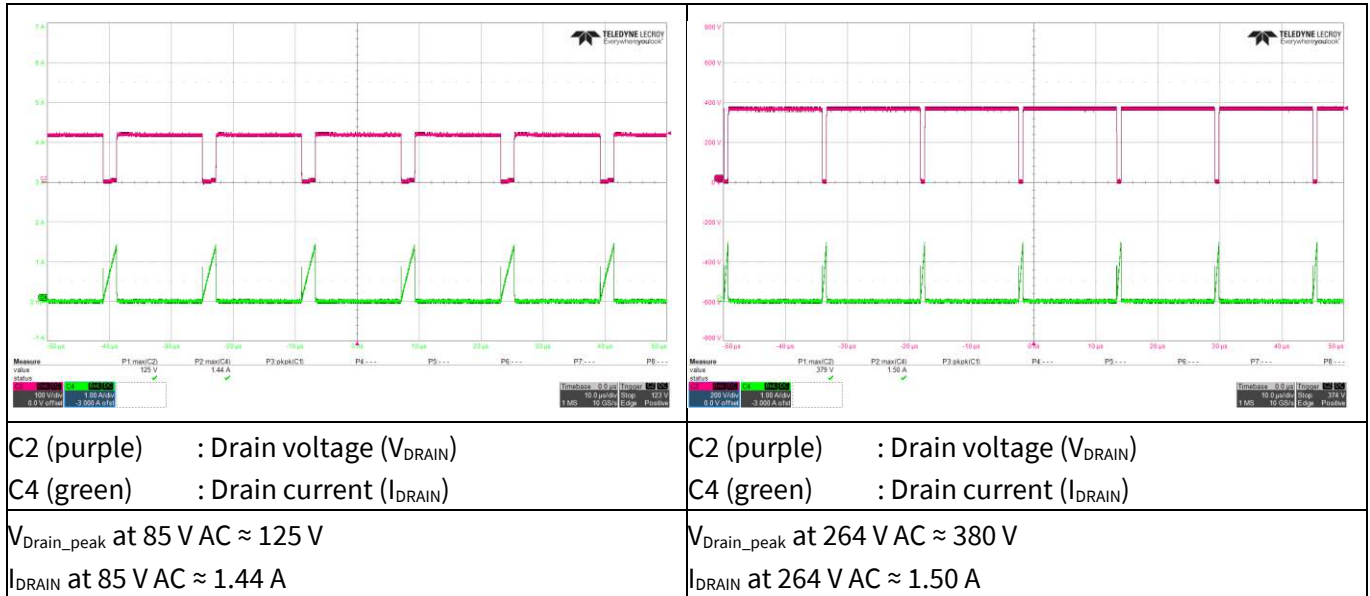

Figure 13 Drain and CS voltage at maximum load

9.4 Output ripple voltage at maximum load

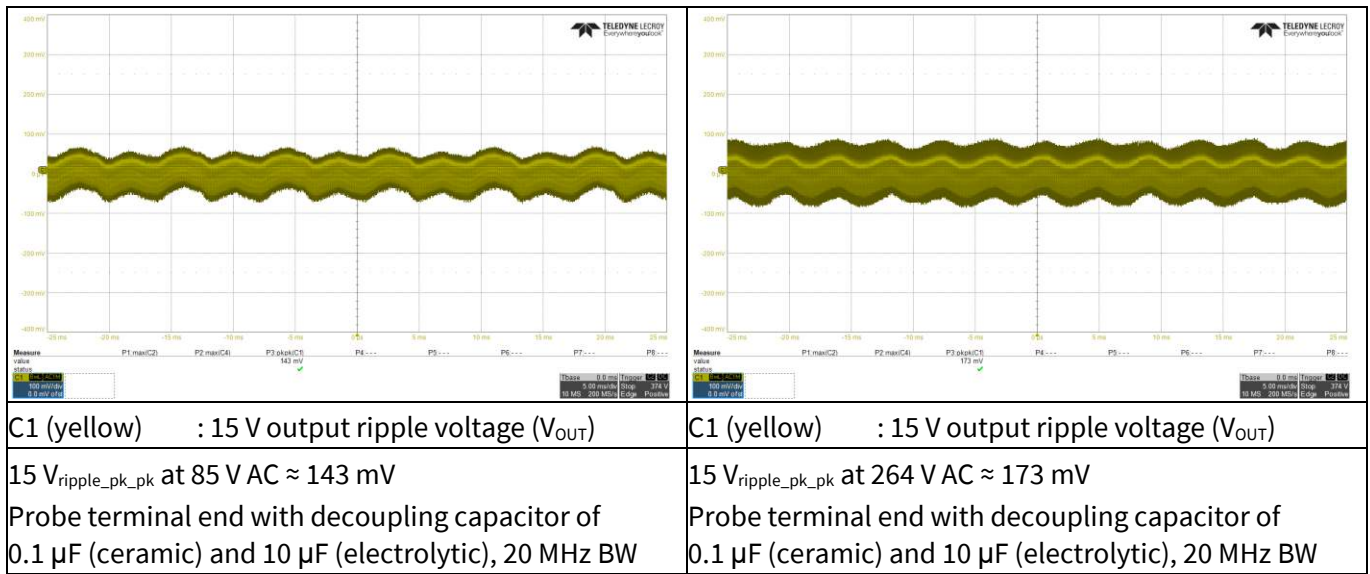

Figure 14 Output ripple voltage at maximum load

Waveforms and scope plots

9.5 ABM operation

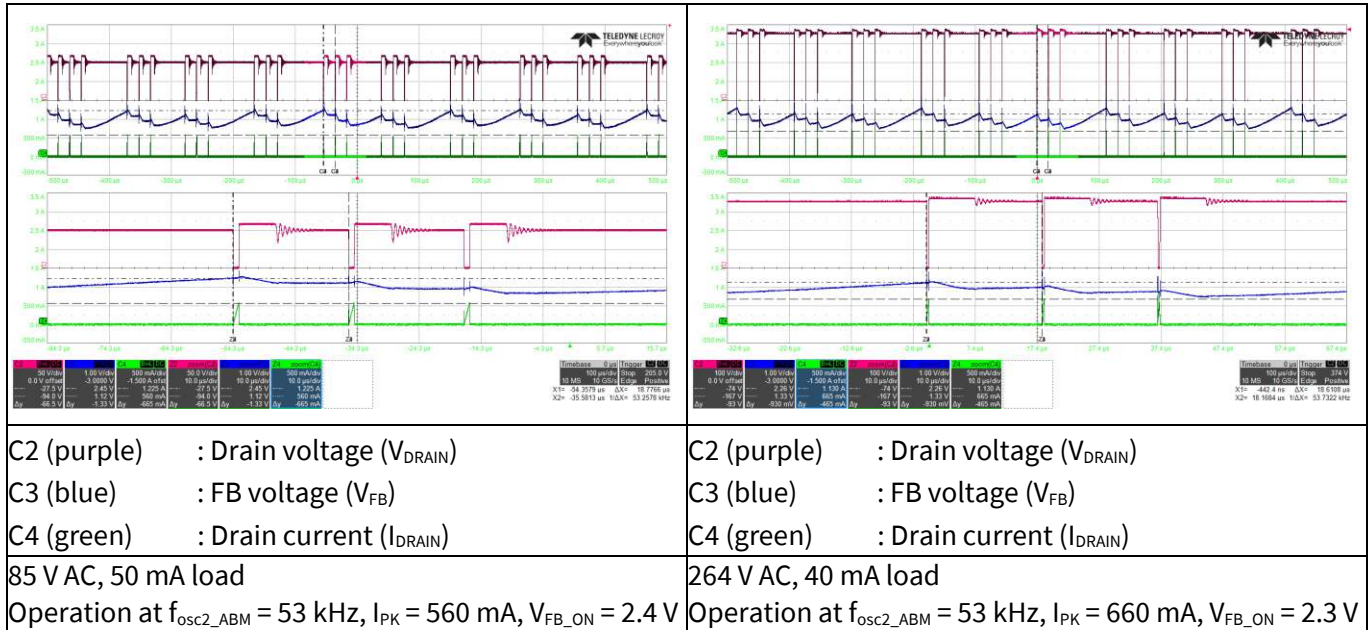

Figure 15 ABM operation

9.6 Overload protection (odd-skip auto-restart)

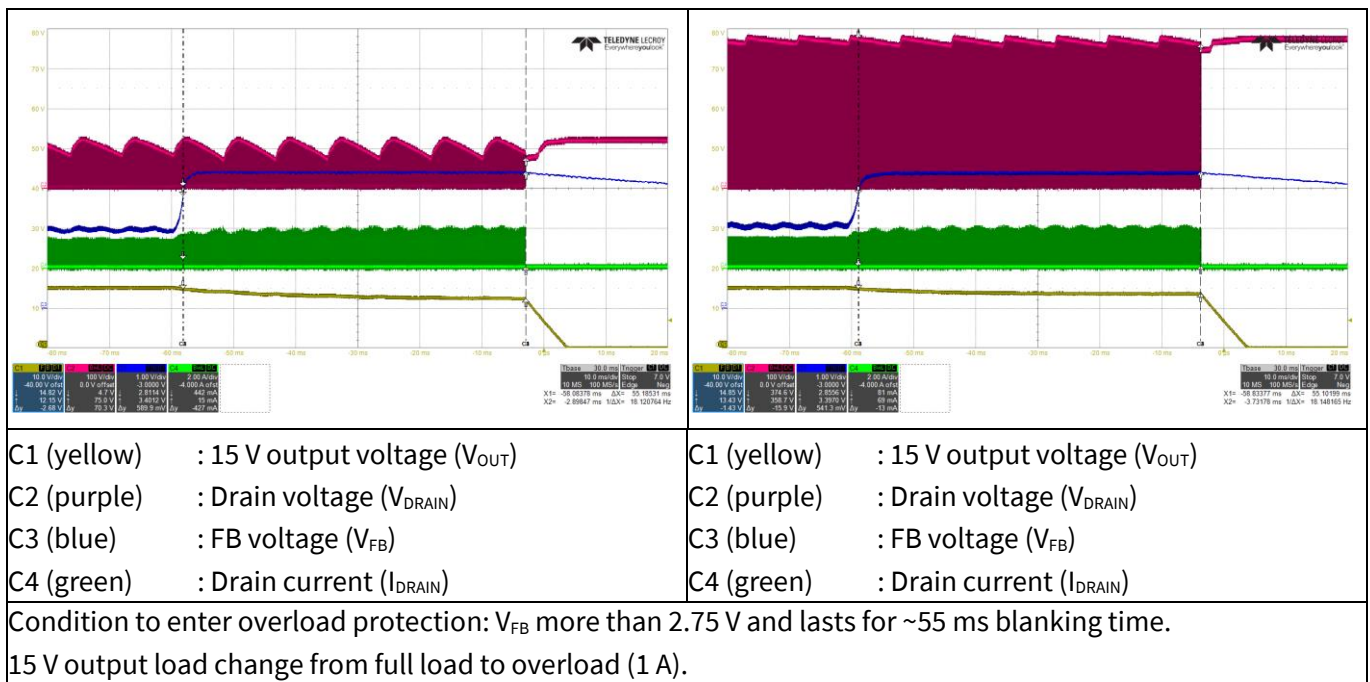
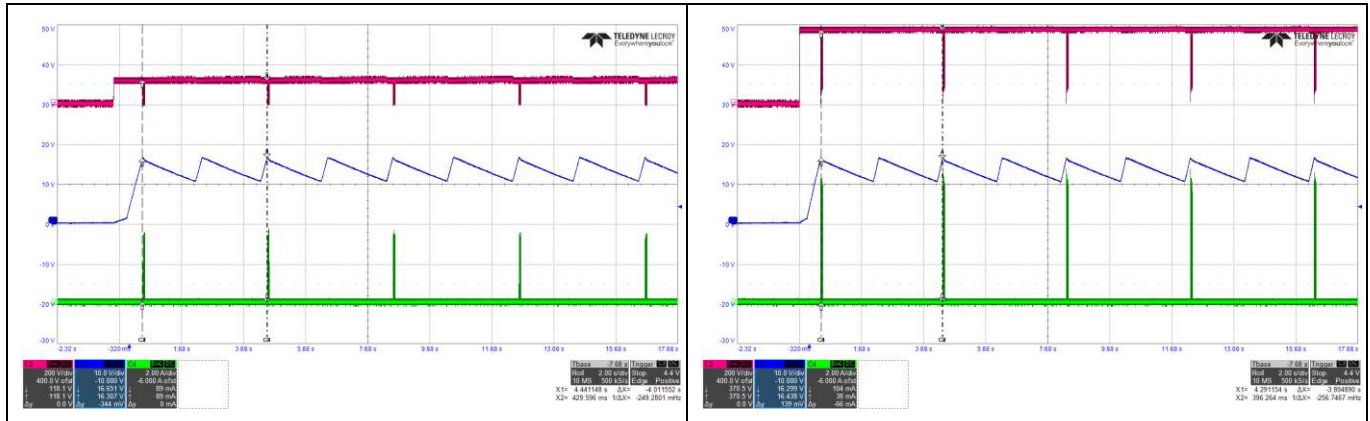

Figure 16 Overload protection

Waveforms and scope plots

9.7 Output short test



C2 (purple) : Drain voltage (V_{DRAIN})	C2 (purple) : Drain voltage (V_{DRAIN})
C3 (blue) : V_{CC} voltage (V_{CC})	C3 (blue) : V_{CC} voltage (V_{CC})
C4 (green) : Drain current (I_{DRAIN})	C4 (green) : Drain current (I_{DRAIN})
IC enters into overload protection in odd-skip auto-restart mode	

Figure 17 Output short test

10 Design example A

In this evaluation board, there is a component placeholder for two low dropout (LDO) regulators connected in series as shown in Figure 18. The 12 V output regulated by IC2 can supply up to 350 mA and the 5 V output regulated by IC3 can supply up to 200 mA.

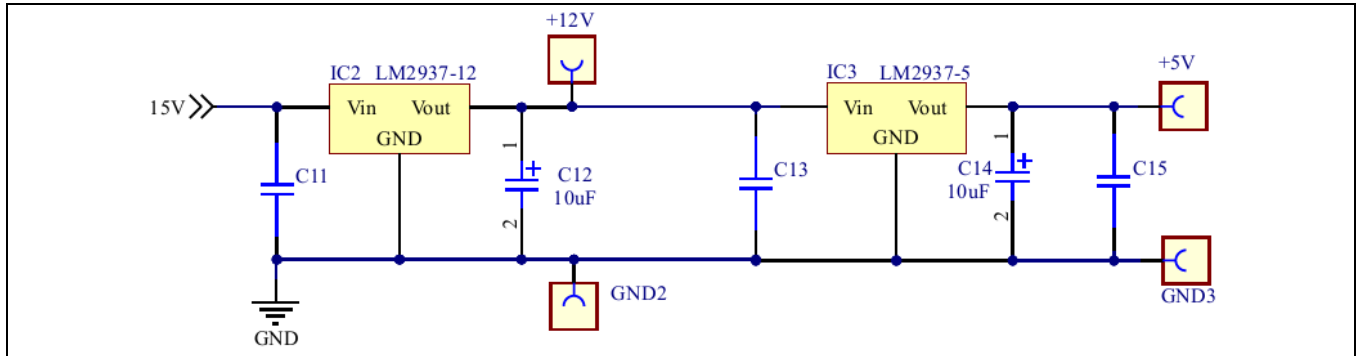

Figure 18 Additional circuit for design example A

Note: Components in the additional circuit shown in Figure 18 are not mounted on the evaluation board.

10.1 Specification of design example A

Since 12 V output and 5 V output are derived from the main output 15 V, the total output current should not exceed maximum capacity of the main output current. The specification of this design example is below.

Table 6 Specification of design example A

Description	Symbol	Value	Comments
Output voltage 1	V_{O1}	15 V	Main output
Max. output current 1	I_{O1}	0.15 A	
Output voltage 2 (via LDO)	V_{O2}	12 V	Derived from 15 V output
Max. output current 2	I_{O2}	0.35 A	
Output voltage 3 (via LDO)	V_{O3}	5 V	Derived from 12 V output
Max. output current 3	I_{O3}	0.2 A	

10.2 Full-load efficiency

Additional power loss caused by LDO circuits will reduce overall efficiency. LDOs are mounted on the heatsink.

Table 7 Full-load efficiency – example A

Input (V AC/Hz)	P_{IN} (W)	V_{O1} (V DC)	I_{O1} (A)	V_{O2} (V DC)	I_{O2} (A)	V_{O3} (V DC)	I_{O3} (A)	P_{OUT} (W)	Efficiency η (%)
85 V AC/60 Hz	12.974	15.10	0.15	11.793	0.35	4.982	0.2	7.389	56.95%
115 V AC/60 Hz	12.894	15.12	0.15	11.793	0.35	4.982	0.2	7.392	57.33%
230 V AC/50 Hz	13.060	15.13	0.15	11.793	0.35	4.982	0.2	7.393	56.61%
264 V AC/50 Hz	13.100	15.14	0.15	11.793	0.35	4.982	0.2	7.394	56.44%

11 References

- [1] Infineon Technologies AG: ICE5BR2280BZ Datasheet (V 1.0); 2022-02-22; [ICE5BR2280BZ Datasheet](#)
- [2] Infineon Technologies AG: Fifth-generation CoolSET™ high-voltage buck design guide (V 1.0); 2022-02-22; [Fifth-generation CoolSET™ high-voltage buck design guide](#)
- [3] Infineon Technologies AG: Calculation tool for fixed-frequency HV buck converter using Gen5 CoolSET™ (Version 1.0); [Gen5 HV buck calculation tool](#)

Revision history

Revision history

Document version	Date of release	Description of changes
V 1.0	2022-06-15	First release

Other Trademarks

All referenced product or service names and trademarks are the property of their respective owners.

Edition 2022-06-15

Published by

Infineon Technologies AG

81726 Munich, Germany

© 2022 Infineon Technologies AG.

All Rights Reserved.

Do you have a question about this document?

Email: erratum@infineon.com

Document reference

ER_2101_PL21_2106_104029

IMPORTANT NOTICE

The information contained in this application note is given as a hint for the implementation of the product only and shall in no event be regarded as a description or warranty of a certain functionality, condition or quality of the product. Before implementation of the product, the recipient of this application note must verify any function and other technical information given herein in the real application. Infineon Technologies hereby disclaims any and all warranties and liabilities of any kind (including without limitation warranties of non-infringement of intellectual property rights of any third party) with respect to any and all information given in this application note.

The data contained in this document is exclusively intended for technically trained staff. It is the responsibility of customer's technical departments to evaluate the suitability of the product for the intended application and the completeness of the product information given in this document with respect to such application.

For further information on the product, technology, delivery terms and conditions and prices please contact your nearest Infineon Technologies office (www.infineon.com).

WARNINGS

Due to technical requirements products may contain dangerous substances. For information on the types in question please contact your nearest Infineon Technologies office.

Except as otherwise explicitly approved by Infineon Technologies in a written document signed by authorized representatives of Infineon Technologies, Infineon Technologies' products may not be used in any applications where a failure of the product or any consequences of the use thereof can reasonably be expected to result in personal injury.