



Part Number: D3C2060

Electrical Specifications

Frequency Range (GHz):	2.0 – 6.0
Isolation (dB):	14 MIN
Insertion Loss (dB):	0.8 MAX
VSWR:	1.5:1 MIN
Forward Power (W):	20 AVG 30 PK

Mechanical/Environmental Specifications

Connector Type:	SMA
Connector Body:	Passivated stainless steel
Connector Pin:	Gold plated copper
Load Body:	Brass
Magnetic Shunt:	Nickel plated CRS
Operational Temp:	0°C to +50°C
Weight (oz)	4.0 MAX

D3C2060 Dimensions

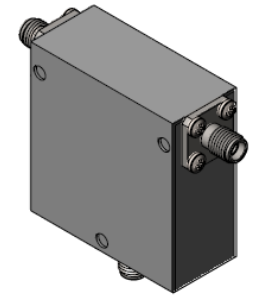
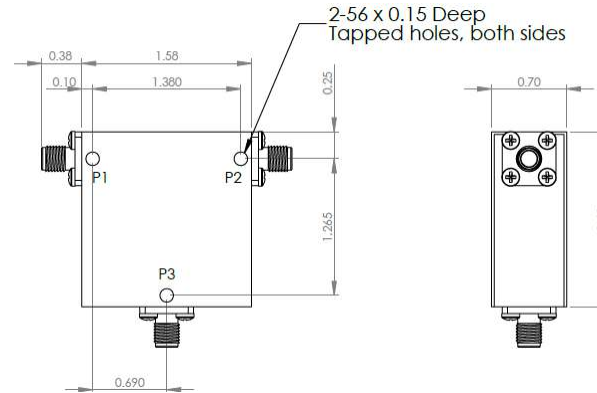

D3C2060-3 Dimensions

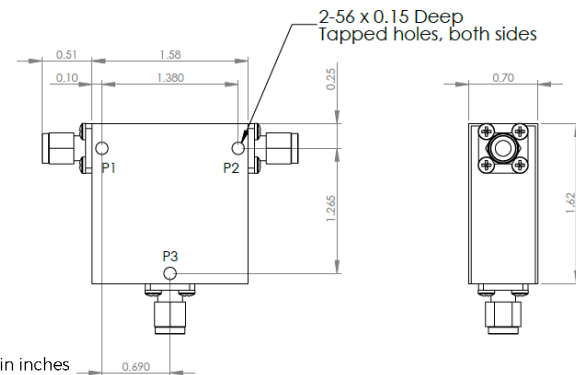

Dimensions are in inches
Tolerance

XX	±0.03
XXX	±0.010

Type of Device	PN Suffix	Connector Configuration Input / Output	PN Example
Single Junction Circulator 3-Port Device Port 1 / Port 2 / Port 3	No Dash	Female / Female / Female	D3C2060
	-1	Male / Female / Female	D3C2060-1
	-2	Female / Male / Female	D3C2060-2
	-3	Male / Male / Male	D3C2060-3
	-4	Female / Female / Male	D3C2060-4
	-5	Male / Female / Male	D3C2060-5
	-6	Male / Male / Female	D3C2060-6
-7	Female / Male / Male	D3C2060-7	



MEASURED DATA

Part Number: D3C2060, P1→P2, P3 Terminated with 50Ω, +25°C

