

Features

- Input Power: -15 to +15 dBm
- Dynamic Range: 30 dB
- DC supply: 4.5 V, 70 μ A
- Lead-Free 3 mm 16-Lead QFN Package
- ESD protected
- RoHS* Compliant

Description

MADT-011000 is a single-ended, internally-matched power detector with wide input bandwidth and high dynamic range. The circuit consumes 70 μ A from a 4.5 V supply, while matched detector and reference diodes provide temperature compensation in differential operation.

The power detector is housed in a 3 mm 16-lead QFN package and is ESD protected for reliability and ease of handling.

MADT-011000 is well suited for power control in microwave radios, test and measurement equipment, and radar applications.

MADT-011000 is also available in bare die format. Refer to datasheet MADT-011000-DIE.

Ordering Information^{1,2}

Part Number	Package
MADT-011000	Bulk
MADT-011000-TR1000	1000 Piece Reel
MADT-011000-SB1	Sample Board

1. Reference Application Note M513 for reel size information.
2. All sample boards include 5 loose parts.

Functional Schematic

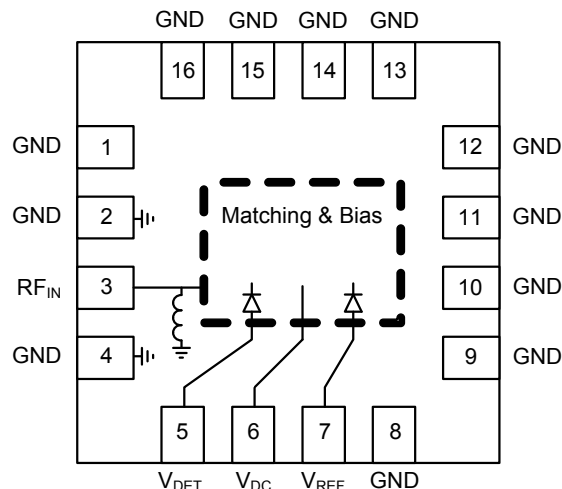

Pin Configuration³

Pin No.	Function
1, 2, 4, 8 - 16	GND ³
3	RF _{IN}
5	V _{DET}
6	V _{DC}
7	V _{REF}
Paddle ⁴	

3. MACOM recommends connecting unused package pins to ground.
4. The exposed pad centered on the package bottom must be connected to RF, DC and thermal ground.

* Restrictions on Hazardous Substances, European Union Directive 2011/65/EU.

Power Detector 5 - 44 GHz

Rev. V1

Electrical Specifications: Freq. = 5 - 44 GHz, $T_A = +25^\circ\text{C}$, $V_{DC} = 4.5\text{ V}$, $Z_0 = 50\ \Omega^5$

Parameter	Test Conditions	Units	Min.	Typ.	Max.
Input Power	—	dBm	-15	—	+15
Dynamic Range	$V_{ref} - V_{det} > 5\text{ mV}$	dB	30	—	—
Vdelta	$V_{delta} = V_{ref} - V_{det}$ Input power = -15 to +15 dBm	mV	5	—	2200
Return Loss	5 - 10 GHz	dB	—	-11	-9
	10 - 12 GHz			-11	-9
	12 - 36 GHz			-15	-9
	36 - 44 GHz			-18	-13
Supply Voltage	—	V	—	4.5	—
Current Consumption	—	μA	60	70	80

5. All specifications refer to CW input signal.

Absolute Maximum Ratings^{6,7}

Parameter	Absolute Maximum
Input Power	18 dBm
VDC	6 V
Operating Temperature	-40°C to $+85^\circ\text{C}$
Storage Temperature	-65°C to $+150^\circ\text{C}$

6. Exceeding any one or combination of these limits may cause permanent damage to this device.
7. MACOM does not recommend sustained operation near these survivability limits.

Handling Procedures

Please observe the following precautions to avoid damage:

Static Sensitivity

These electronic devices are sensitive to electrostatic discharge (ESD) and can be damaged by static electricity. Proper ESD control techniques should be used when handling these Class 1B devices.

Application Circuit^{8,9}

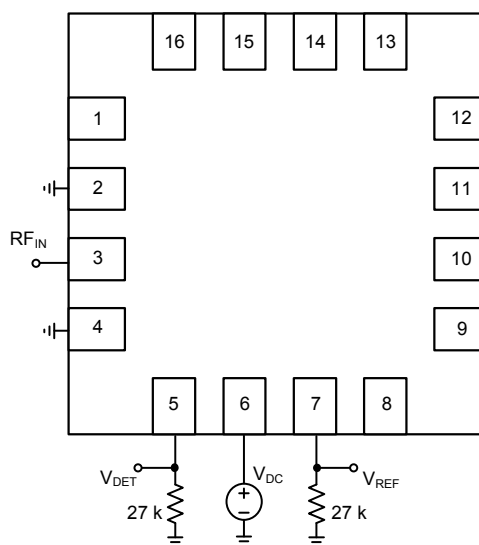

8. External 27 k Ω resistors are recommended for optimum performance.
9. Typical $V_{ref} = 0.74\text{ V}$

Power Detector 5 - 44 GHz

Rev. V1

Typical Performance Curves: $T_A = 25^\circ\text{C}$

Vdelta vs. Input Power, 5 - 10 GHz

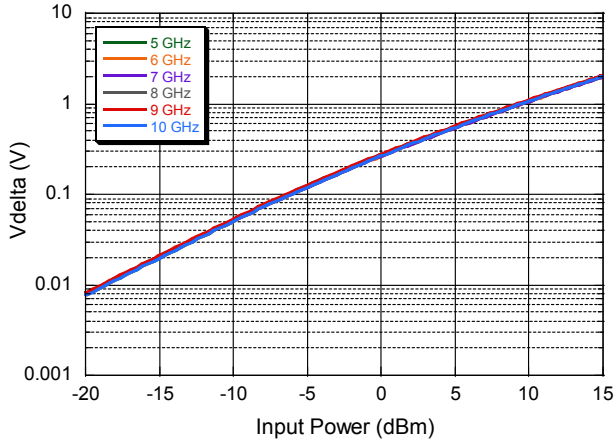

Vdelta vs. Input Power, 11 - 17 GHz

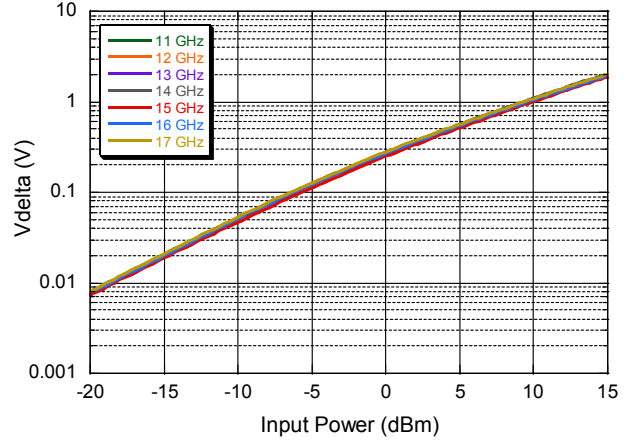

Vdelta vs. Input Power, 18 - 24 GHz

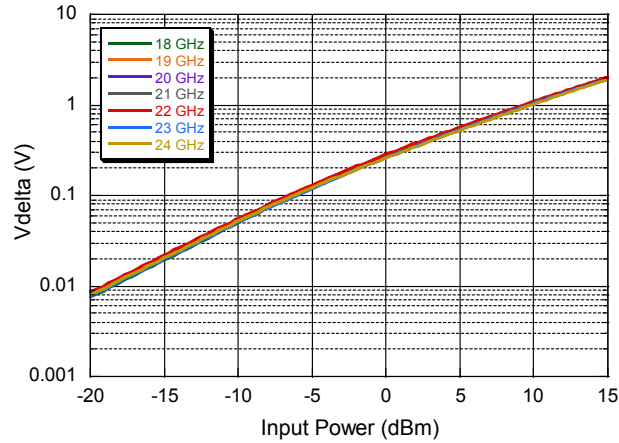

Vdelta vs. Input Power, 25 - 31 GHz

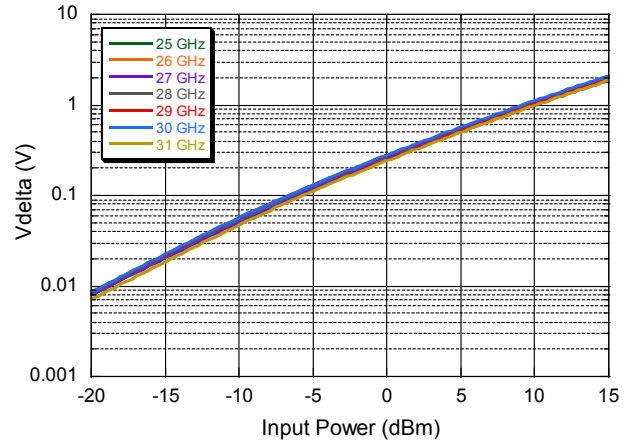

Vdelta vs. Input Power, 32 - 38 GHz

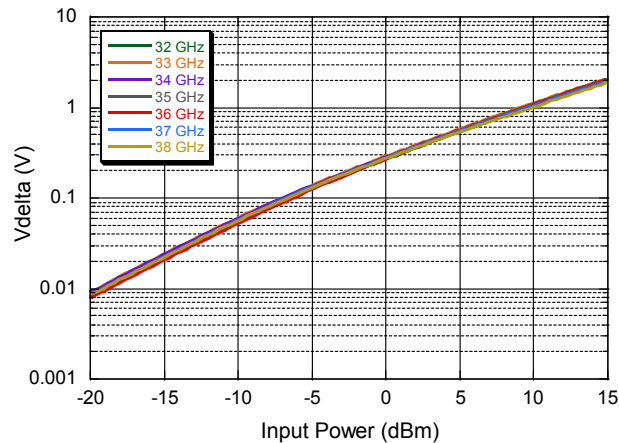

Vdelta vs. Input Power, 39 - 44 GHz

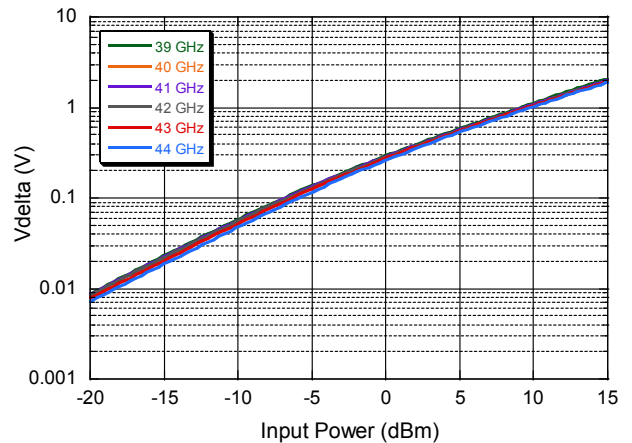

Typical Performance Curves - Over Temperature

Vdelta vs. Temperature, 5 GHz

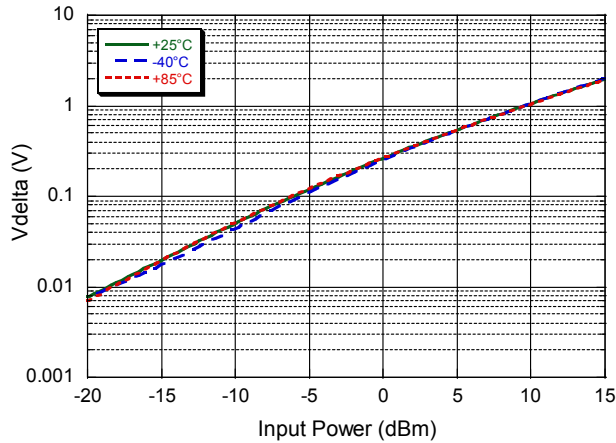

Vdelta vs. Temperature, 15 GHz

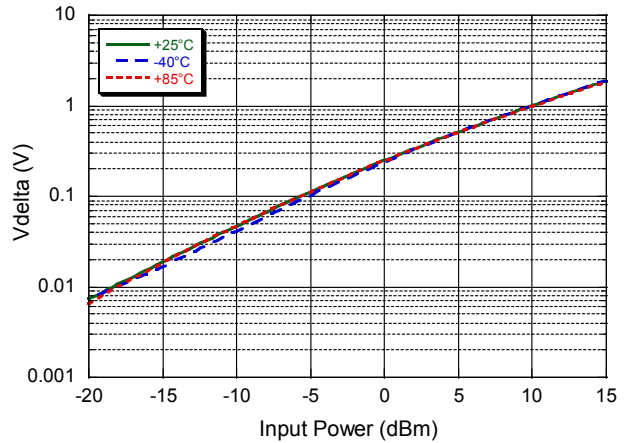

Vdelta vs. Temperature, 23 GHz

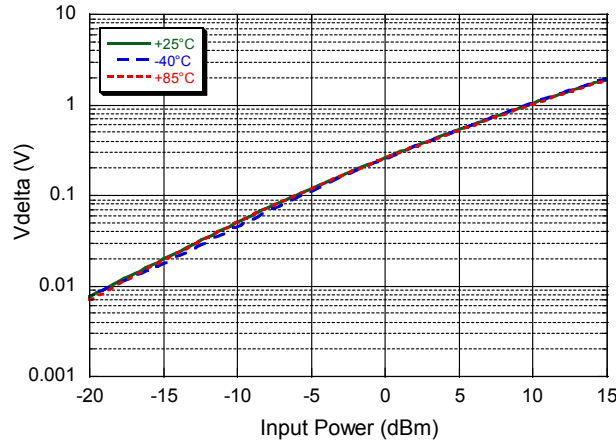

Vdelta vs. Temperature, 30 GHz

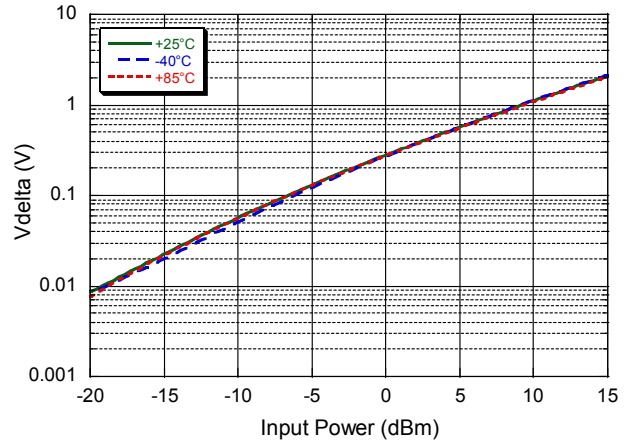

Vdelta vs. Temperature, 38 GHz

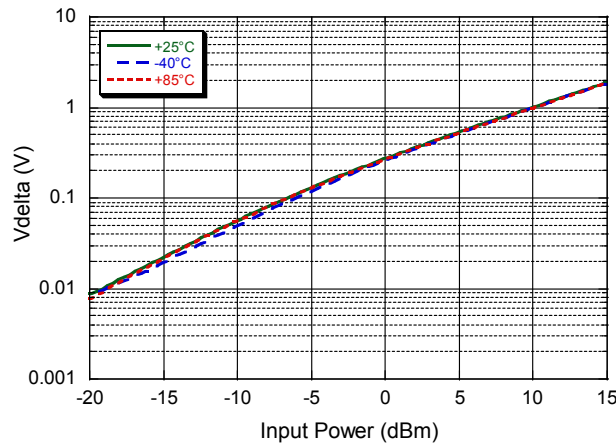

Vdelta vs. Temperature, 44 GHz

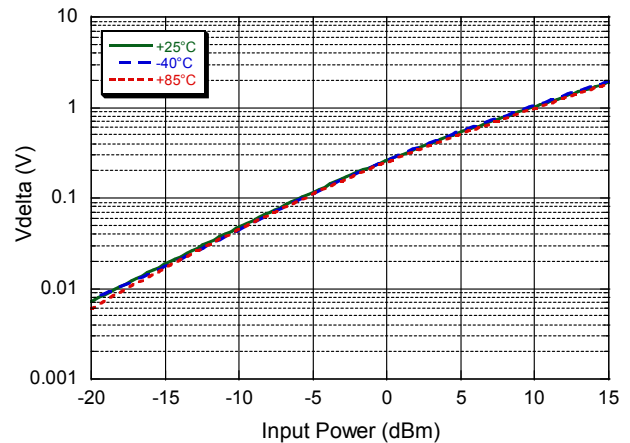

Typical Performance Curves

Vdelta vs. Frequency, $P_{IN} = -15$ dBm

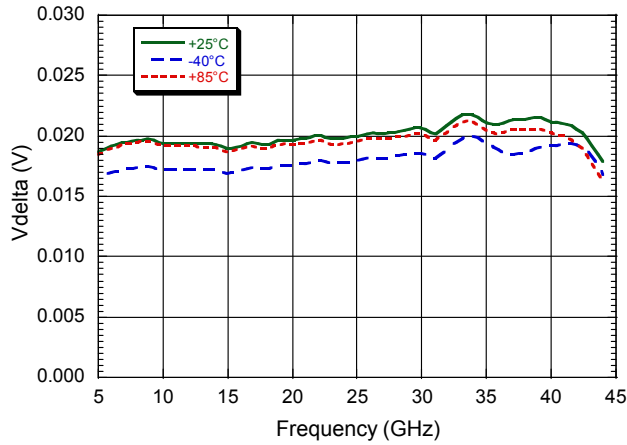

Vdelta vs. Frequency, $P_{IN} = 0$ dBm

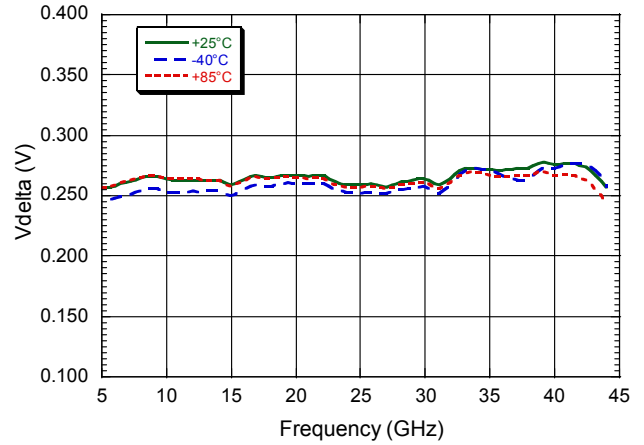

Vdelta vs. Frequency, $P_{IN} = +15$ dBm

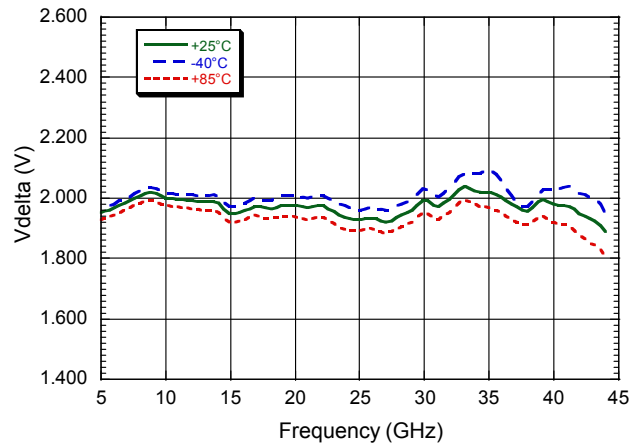

Input Return Loss vs. Frequency

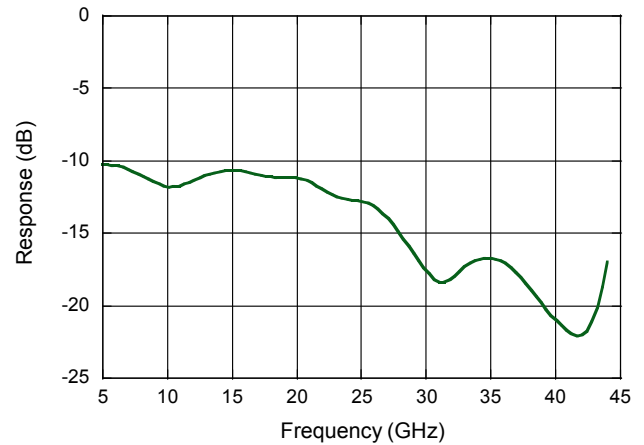

Lead-Free 3 mm 16-Lead PQFN[†]

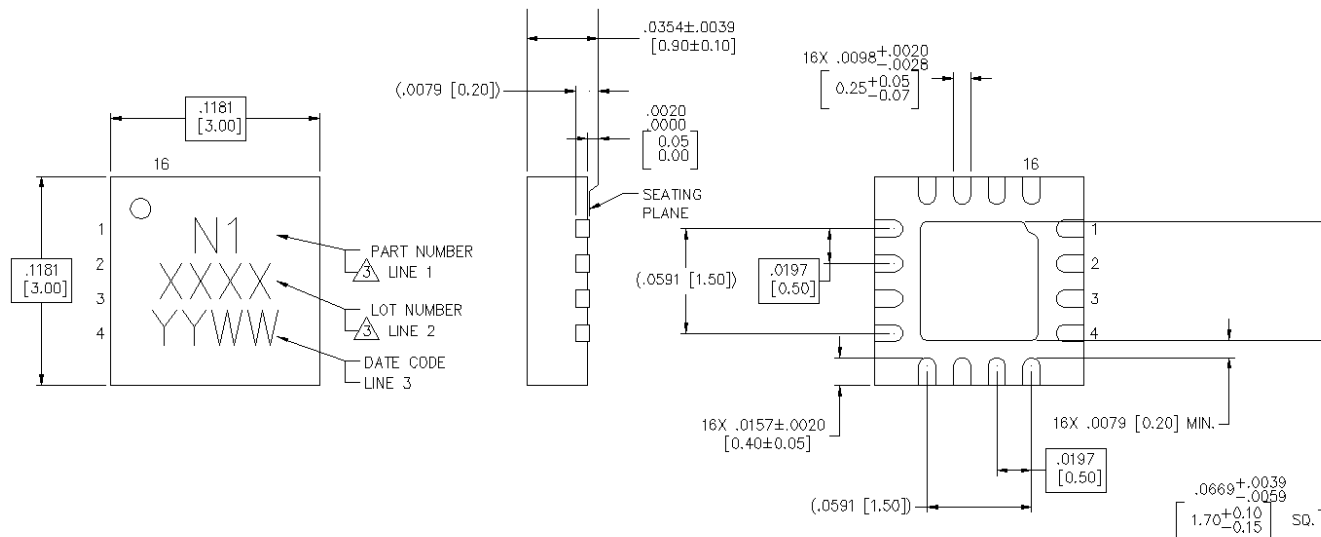

[†] Reference Application Note S2083 for lead-free solder reflow recommendations.
Meets JEDEC moisture sensitivity level 1 requirements.
Plating is NiPdAuAg

MACOM Technology Solutions Inc. All rights reserved.

Information in this document is provided in connection with MACOM Technology Solutions Inc ("MACOM") products. These materials are provided by MACOM as a service to its customers and may be used for informational purposes only. Except as provided in MACOM's Terms and Conditions of Sale for such products or in any separate agreement related to this document, MACOM assumes no liability whatsoever. MACOM assumes no responsibility for errors or omissions in these materials. MACOM may make changes to specifications and product descriptions at any time, without notice. MACOM makes no commitment to update the information and shall have no responsibility whatsoever for conflicts or incompatibilities arising from future changes to its specifications and product descriptions. No license, express or implied, by estoppel or otherwise, to any intellectual property rights is granted by this document.

THESE MATERIALS ARE PROVIDED "AS IS" WITHOUT WARRANTY OF ANY KIND, EITHER EXPRESS OR IMPLIED, RELATING TO SALE AND/OR USE OF MACOM PRODUCTS INCLUDING LIABILITY OR WARRANTIES RELATING TO FITNESS FOR A PARTICULAR PURPOSE, CONSEQUENTIAL OR INCIDENTAL DAMAGES, MERCHANTABILITY, OR INFRINGEMENT OF ANY PATENT, COPYRIGHT OR OTHER INTELLECTUAL PROPERTY RIGHT. MACOM FURTHER DOES NOT WARRANT THE ACCURACY OR COMPLETENESS OF THE INFORMATION, TEXT, GRAPHICS OR OTHER ITEMS CONTAINED WITHIN THESE MATERIALS. MACOM SHALL NOT BE LIABLE FOR ANY SPECIAL, INDIRECT, INCIDENTAL, OR CONSEQUENTIAL DAMAGES, INCLUDING WITHOUT LIMITATION, LOST REVENUES OR LOST PROFITS, WHICH MAY RESULT FROM THE USE OF THESE MATERIALS.

MACOM products are not intended for use in medical, lifesaving or life sustaining applications. MACOM customers using or selling MACOM products for use in such applications do so at their own risk and agree to fully indemnify MACOM for any damages resulting from such improper use or sale.