

Bridgelux Vero 13 Array Series

Product Data Sheet DS31– Published April 16th 2013

**BXRC-27x2000, BXRC-30x2000, BXRC-35E2000, BXRC-40E2000,
BXRC-50C2000**



Introduction

Vero™ represents a revolutionary advancement in chip on board (COB) light source technology and innovation. These new LED light sources simplify luminaire design and manufacturing processes, improve light quality, and define a platform for future functionality integration.

Vero is available in four different LES (light emitting surface) configurations and has been engineered to reliably operate over a broad current range, enabling new degrees of flexibility in luminaire design optimization. These new arrays deliver increased lumen density to enable improved beam control and precision lighting with 3 SDCM color control standard for clean and consistent uniform lighting.

Vero includes an on board connector port to enable solder free electrical interconnect and simple easy to use mounting features to enable plug-and-play installation.

Features

- Vero 13 lumen output performance ranges from 400 to as much as 3,800 lumens
- Broad range of CCT options from 2700K to 5000K
- CRI options include; minimum 70, 80, 90 for standard and 97 typical for Decor products
- 3SDCM standard for 2700K-4000K CCT options
- Reliable operation at up to 2X nominal drive current
- Radial die pattern and improved lumen density
- Thermally isolated solder pads
- Onboard connector port
- Top side part number markings

Benefits

- Broad application coverage for interior and exterior lighting
- Flexibility to respond to application driven lighting design requirements
- High quality true color reproduction
- Uniform consistent white light
- Flexibility in design optimization
- Improved optical control
- Enhanced ease of use and manufacturability
- Solder-less connectivity enables plug & play installation and field upgradability
- Improved inventory management and quality control



Table of Contents	Page
Product Feature Map	3
Product Nomenclature	3
Top Side Part Number Markings	4
Enhanced Connectivity Options	4
Lumen Maintenance Characteristics	4
Environmental Compliance	4
UL Recognition	5
CE Recognition	5
Minor Product Change Policy	5
Cautionary Statements	5
Case Temperature Measurement Point	6
Product Selection Guide	7
Product Selection Guide (continued)	8
Typical Performance at Alternative Drive Currents	8
Flux Characteristics	10
Electrical Characteristics	11
Absolute Minimum and Maximum Ratings	12
Typical Forward Current Characteristics	13
Typical Relative Luminous Flux vs. Current, $T_j=25^\circ\text{C}$	14
Typical Light Output Characteristics vs. Temperature	15
Typical Chromaticity Characteristics vs. Temperature	16
Optical Characteristics	17
Wavelength Characteristics at Rated Test Current, $T_j=25^\circ\text{C}$	18
Mechanical Dimensions	19
Color Control Information	20
Design Resources	23

Product Feature Map

Vero 13 is the second smallest form factor in the exciting new Vero family of next generation solid state light sources. In addition to delivering the performance and light quality required for many lighting applications, Vero incorporates several features to simplify the design integration and manufacturing process, accelerate time to market and reduce system costs. Please consult the Bridgelux Vero Array Series Product Brief for more information on the Vero family of products.

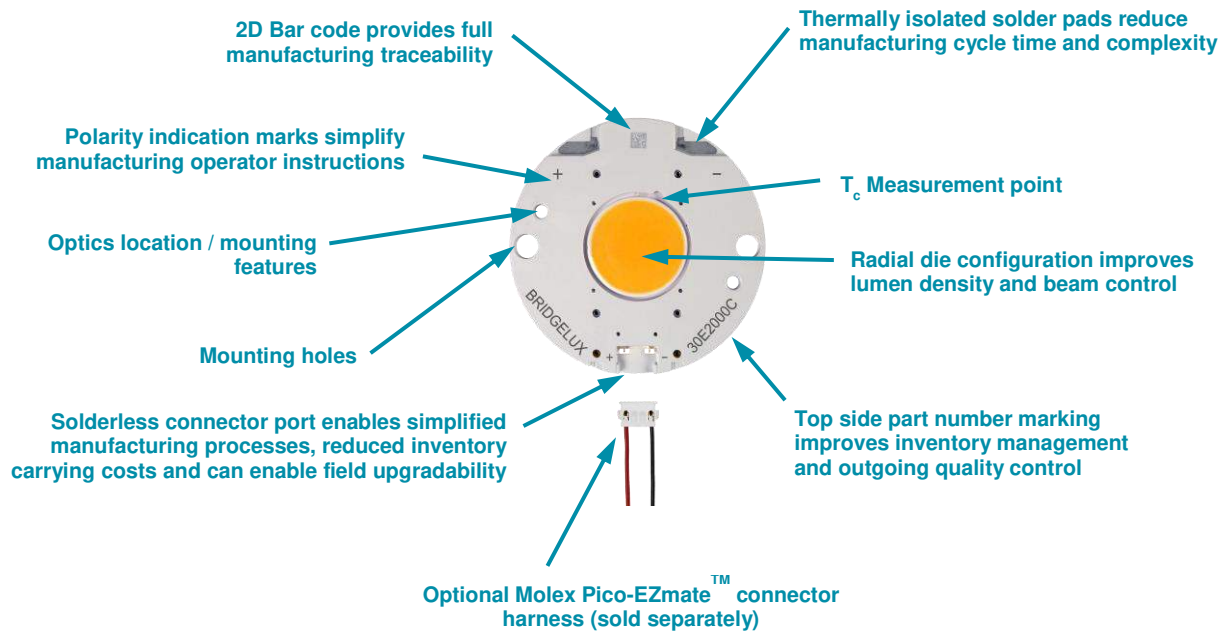

Product Nomenclature

The part number designation for Bridgelux Vero LED arrays is explained as follows:

BXRC – AB C DEFG – H – IJ

Where:

BXRC – Designates product family

AB – Designates the nominal color temperature; 27 = 2700K; 30 = 3000K, etc.

C – Designates minimum CRI; C = 70, E = 80, G = 90, H = 95

DEFG – Designates nominal flux; 1000 = 1000 lm, 2000 = 2000 lm, etc.

H – Designates array configuration

IJ – Designates CCT Bin options

03 = 3 SDCM

04 = 4 SDCM

Top Side Part Number Markings

Vero includes a top side part number marking to help simplify inventory management and increase opportunities for production quality control. Any Vero product can be quickly identified to determine the product configuration, color or CRI by simply looking at its top side markings. Unlike previous product generations where markings were included only on the back side of the array, no longer is it necessary to handle (turnover), uninstall the array in an infield application or guess which product it is by the color of the phosphor area. The Vero line of LED array products also has a 2D bar code which provides additional information and full product traceability for quality control purposes.

Enhanced Connectivity Options

Vero's thermally isolated solder pads have been designed to make soldering fast and secure. For those who prefer an even faster solderless installation, Vero has a connector port that can be used to further simplify your manufacturing process, reduce inventory cost and allow for field upgradability. The connector port mates to the Molex Pico-EZmate connector harness, sold separately by Molex and through their distribution network. The Molex connector harnesses come in a variety of wire lengths and wire gauge options and can also be custom engineered to meet your specific design requirements. Please consult your local Molex sales representative or visit www.molex.com for more information.

Lumen Maintenance Characteristics

Bridgelux projects that the Vero family of LED array products will deliver, on average, greater than 70% lumen maintenance after 50,000 hours of operation at the rated forward test current. This performance assumes constant current operation at the nominal test current (1X drive current as is indicated in Table 4) with case temperature maintained at or below 85°C. For use beyond these typical operating conditions please consult your Bridgelux sales representative for further assistance. Bridgelux conducts lumen maintenance tests per LM80. Observation of design limits is required in order to achieve this projected lumen maintenance.

Environmental Compliance

Bridgelux is committed to providing environmentally friendly products to the solid-state lighting market. Vero LED Arrays comply with the European Union directives on the restriction of hazardous substances in electronic equipment, namely the RoHS directive. Bridgelux does not intentionally add the following restricted materials to any LED array products: lead, mercury, cadmium, hexavalent chromium, polybrominated biphenyls (PBB) or polybrominated diphenyl ethers (PBDE).

UL Recognition

Bridgelux secures UL Recognition for all of its LED array products. Please refer to the UL file 357031 for the latest list of UL Recognized Bridgelux LED arrays. The Vero series of LED arrays are currently undergoing UL testing, and the UL file will be updated as tests are complete to satisfy UL recognition requirements. Bridgelux uses UL Recognized materials with suitable flammability ratings in the Vero LED array products to streamline the process for customers to secure UL listing of the final luminaire product. Bridgelux recommends that luminaires are designed with a Class 2 driver to facilitate the UL listing process.

CE Recognition

In accordance with the relevant European Union Directives, the BXRC series LED array products conform to the applicable requirements of the IEC/EN 62031:2008 (LED Modules for General Lighting Safety Specifications) and IEC 62471:2006 (Photobiological Safety of Lamps and Lamp Systems). The Vero series of LED arrays are currently undergoing UL and CE testing and are expected to be completed shortly. Bridgelux maintains a CE Declaration of Conformity statement on its website and displays the CE mark on product packing labels.

Minor Product Change Policy

The rigorous qualification testing on products offered by Bridgelux provides performance assurance. Slight cosmetic changes that do not affect form, fit, or function may occur as Bridgelux continues product optimization.

Cautionary Statements

CAUTION: CONTACT WITH OPTICAL AREA

Avoid any contact with the optical area. Do not touch the optical area of the Vero LED array or apply stress to the yellow phosphor resin area. Contact may cause damage to the LED array.

Optics and reflectors must not be mounted in contact with the yellow phosphor resin area. Optical devices may be mounted on the top surface of the plastic housing of the Vero LED array. Use the mechanical features of the LED array housing, edges and/or mounting holes to locate and secure optical devices as needed.

CAUTION: EYE SAFETY

Eye safety classification for the use of Bridgelux Vero LED arrays is in accordance with IEC specification EN62471:Photobiological Safety of Lamps and Lamp Systems. Vero LED arrays are classified as Risk Group 1 (Low Risk) when operated at or below the maximum DC forward current (2x the nominal rated test current as is defined in Table 6 of this data sheet). Please use appropriate precautions. It is important that employees working with LEDs are trained to use them safely.

CAUTION: RISK OF BURN

Do not touch the Vero LED array or yellow resin area during operation. Allow the array to cool for a sufficient period of time before handling. The Vero LED array may reach elevated temperatures such that could burn skin when touched.

CAUTION: CHEMICAL EXPOSURE HAZARD

Exposure to some chemicals commonly used in luminaire manufacturing and assembly can cause damage to the LED array. Please consult Bridgelux Application Note AN31 for additional information.

Case Temperature Measurement Point

A case temperature measurement point location is included on the top surface of the Vero LED arrays. The location of this measurement point is indicated in the mechanical dimensions section of this data sheet.

The purpose of this measurement point is to allow the user access to a measurement point correlates to the true case temperature on the back surface of the LED array. Once the LED array is installed, it is challenging to measure the back surface of the array, or true case temperature.

For consistent and repeatable temperature measurements can be correlated to the data sheet performance specifications and to published LM-80 reliability data. The use of case temperature measurements point is more fully explained in AN30.

Product Selection Guide

The following product configurations are available:

Table 1: Selection Guide, Pulsed Measurement Data
($T_j = 25^\circ\text{C}$, $T_c = 25^\circ\text{C}$)

Part Number	Nominal CCT (K)	CRI	Color Control [1,2]	Test Current (mA)	Typical Pulsed Flux $T_j = 25^\circ\text{C}$ (lm)	Typical V_f (V)	Typical Power (W)	Typical Efficacy (lm/W)
BXRC-27E2000-C-03	2700	80	3 SDCM	500	1740	32.7	16.4	106
BXRC-27G2000-C-03	2700	90	3 SDCM	500	1390	32.7	16.4	85
BXRC-27H2000-C-03	2700	97	3 SDCM	500	1120	32.7	16.4	68
BXRC-30E2000-C-03	3000	80	3 SDCM	500	1800	32.7	16.4	110
BXRC-30G2000-C-03	3000	90	3 SDCM	500	1480	32.7	16.4	90
BXRC-30H2000-C-03	3000	97	3 SDCM	500	1210	32.7	16.4	74
BXRC-35E2000-C-03	3500	80	3 SDCM	500	1870	32.7	16.4	114
BXRC-40E2000-C-03	4000	80	3 SDCM	500	1900	32.7	16.4	116
BXRC-50C2000-C-04	5000	70	4 SDCM	500	2100	32.7	16.4	128

Notes for Table 1:

1. 3SDCM (3-Step) Color control standard on 2700K, 3000K, 3500K and 4000K configurations.
2. 4SDCM (4-Step) Color control standard on 5000K configurations.
3. Bridgelux maintains a $\pm 7\%$ tolerance on flux measurements.
4. Typical stabilized DC performance values are provided as reference only and are not a guarantee of performance.

Product Selection Guide (continued)

Table 2: Selection Guide, Stabilized DC Performance
($T_c = 85^\circ\text{C}$)

Part Number	Nominal CCT (K)	CRI	Test Current (mA)	Typical DC Flux $T_c = 85^\circ\text{C}$ (lm) ^[1,2]	Typical V_f (V)	Typical Power (W)	Typical Efficacy (lm/W)
BXRC-27E2000-C-03	2700	80	500	1510	30.7	15.4	98
BXRC-27G2000-C-03	2700	90	500	1210	30.7	15.4	79
BXRC-27H2000-C-03	2700	97	500	970	30.7	15.4	63
BXRC-30E2000-C-03	3000	80	500	1570	30.7	15.4	102
BXRC-30G2000-C-03	3000	90	500	1290	30.7	15.4	84
BXRC-30H2000-C-03	3000	97	500	1050	30.7	15.4	68
BXRC-35E2000-C-03	3500	80	500	1650	30.7	15.4	107
BXRC-40E2000-C-03	4000	80	500	1670	30.7	15.4	109
BXRC-50C2000-C-04	5000	70	500	1830	30.7	15.4	119

Notes for Table 2:

1. Typical stabilized DC performance values are provided as reference only and are not a guarantee of performance.
2. Typical performance when driven under DC (direct current) at test current with LED array case temperature maintained at 85°C , mounted to heat sink with thermal interface material. Based on Bridgelux test setup, values may vary depending on the thermal design of the luminaire and/or the exposed environment to which the product is subjected.
3. Bridgelux maintains a $\pm 7\%$ tolerance on flux measurements.
4. Typical stabilized DC performance values are provided as reference only and are not a guarantee of performance.

Typical Performance at Alternative Drive Currents

Vero LED arrays are tested to the specifications shown in Tables 4 and 5. Vero may also be driven at alternative drive currents dependent on specific application design requirements. Typical performance at any drive current can be derived from the current vs. voltage characteristics shown in Figure 1 and the flux vs. current characteristics shown in Figure 2. Typical performance at common drive currents is summarized in Table 3.

Table 3: Typical Product Performance at Alternative Drive Currents

Part Number	CRI	Current (mA) ^[1]	Typical V _f T _j = 25°C (V)	Typical Watt T _j = 25°C (W)	Typical Flux T _j = 25°C (lm) ^[2,3]	Typical DC Flux T _c = 85°C (lm) ^[2,3]	Typical Efficacy T _j = 25°C (lm/W)
BXRC-27E2000-C-03	80	165	30.2	5.0	610	540	122
		350	31.3	11.0	1220	1070	111
		500	32.7	16.4	1740	1510	106
		700	33.9	23.7	2260	1940	95
		1050	36.1	37.9	3140	2610	83
BXRC-27G2000-C-03	90	165	30.2	5.0	490	440	98
		350	31.3	11.0	990	870	90
		500	32.7	16.4	1390	1210	85
		700	33.9	23.7	1810	1560	76
		1050	36.1	37.9	2510	2080	66
BXRC-27H2000-C-03	97	165	30.2	5.0	400	360	80
		350	31.3	11.0	800	700	73
		500	32.7	16.4	1120	970	68
		700	33.9	23.7	1470	1260	62
		1050	36.1	37.9	2030	1680	54
BXRC-30E2000-C-03	80	165	30.2	5.0	640	570	128
		350	31.3	11.0	1290	1140	118
		500	32.7	16.4	1800	1570	110
		700	33.9	23.7	2355	2030	99
		1050	36.1	37.9	3260	2710	86
BXRC-30G2000-C-03	90	165	30.2	5.0	530	470	106
		350	31.3	11.0	1060	930	97
		500	32.7	16.4	1480	1290	90
		700	33.9	23.7	1940	1670	82
		1050	36.1	37.9	2690	2230	71
BXRC-30H2000-C-03	97	165	30.2	5.0	430	380	86
		350	31.3	11.0	860	760	78
		500	32.7	16.4	1210	1050	74
		700	33.9	23.7	1580	1360	67
		1050	36.1	37.9	2180	1810	58
BXRC-35E2000-C-03	80	165	30.2	5.0	660	590	132
		350	31.3	11.0	1330	1180	121
		500	32.7	16.4	1870	1650	114
		700	33.9	23.7	2440	2120	103
		1050	36.1	37.9	3370	2830	89
BXRC-40E2000-C-03	80	165	30.2	5.0	680	610	136
		350	31.3	11.0	1370	1220	125
		500	32.7	16.4	1900	1670	116
		700	33.9	23.7	2490	2170	105
		1050	36.1	37.9	3450	2900	91
BXRC-50C2000-C-04	70	165	30.2	5.0	740	650	148
		350	31.3	11.0	1495	1320	136
		500	32.7	16.4	2100	1830	128
		700	33.9	23.7	2745	2330	116
		1050	36.1	37.9	3810	3120	101

Notes for Table 3:

1. Product is tested and binned at the rated (nominal) test current included in Table 4 and indicated in **bold** font and blue highlighted rows in the table above.
2. Bridgelux maintains a ± 7% tolerance on flux measurements.
3. Typical stabilized DC performance values are provided as reference only and are not a guarantee of performance.

Flux Characteristics

Table 4: Flux Characteristics

CCT (K)	Part Number	CRI (min) ^[3]	Test Current (mA) ^[1]	Typical Pulsed Flux $T_j = 25^\circ\text{C}$ (lm) ^[1]	Minimum Pulsed Flux $T_j = 25^\circ\text{C}$ (lm) ^[1,2,8]	Typical Center Beam Candle Power $T_j = 25^\circ\text{C}$ (cd) ^[4]	Typical DC Flux $T_c = 85^\circ\text{C}$ (lm) ^[5,6]	Minimum DC Flux $T_c = 85^\circ\text{C}$ (lm) ^[7]
2700	BXRC-27E2000-C-03	80	500	1740	1550	550	1510	1350
	BXRC-27G2000-C-03	90	500	1390	1210	440	1210	1050
	BXRC-27H2000-C-03	95	500	1120	1005	360	970	870
3000	BXRC-30E2000-C-03	80	500	1800	1595	570	1570	1390
	BXRC-30G2000-C-03	90	500	1480	1350	470	1290	1170
	BXRC-30H2000-C-03	95	500	1210	1090	390	1050	950
3500	BXRC-35E2000-C-03	80	500	1870	1720	595	1650	1510
4000	BXRC-40E2000-C-03	80	500	1900	1730	600	1670	1520
5000	BXRC-50C2000-C-04	70	500	2100	1870	670	1830	1630

Notes for Table 4:

- Parts are tested in pulsed conditions, $T_j = 25^\circ\text{C}$. Pulse width is 10 ms at rated test current.
- Bridgelux maintains a $\pm 7\%$ tolerance on flux measurements.
- Typical R9 value for 90 CRI product options is 70. Typical CRI for Decor products is 97 with a minimum R9 of 95.
- Center beam candle power is a calculated value based on Lambertian radiation pattern at nominal test current.
- Typical stabilized DC performance values are provided as reference only and are not a guarantee of performance.
- Typical performance when driven under DC (direct current) at test current with LED array case temperature maintained at 85°C , mounted to heat sink with thermal interface material. Based on Bridgelux test setup, values may vary depending on the thermal design of the luminaire and/or the environment in which the product is operated.
- Minimum DC Flux values are provided for reference only and are not a parameter guaranteed by 100% production testing. Based on Bridgelux test setup, values may vary depending on the thermal design of the luminaire and/or the exposed environment to which the product is subjected.
- Refer to Table 3 for typical performance at other driver currents (including those commonly commercially available).

Electrical Characteristics

Table 5: Electrical Characteristics and Driver Selection Voltages

Current (mA) ^[1]	Forward Voltage Pulsed, T _j = 25°C ^[1,2,3]			Typical Coefficient of Forward Voltage $\Delta V_f / \Delta T_j$ ^[5] (mV/°C)	Typical Thermal Resistance Junction to Case R θ_{j-c} (C/W)	Driver Selection Voltages ^[4]	
	Min. (V)	Typ. (V)	Max. (V)			V _f Min. Hot T _c = 105°C (V)	V _f Max. Cold T _c = - 40°C (V)
165	27.8	30.2	32.6	-24	0.80	25.9	34.1
350	28.8	31.3	33.8	-24	0.85	26.8	35.3
500	30.1	32.7	35.3	-24	0.88	27.8	36.5
700	31.2	33.9	36.6	-24	0.90	29.1	38.2
1050	33.2	36.1	39.0	-24	0.99	31.1	40.6

Notes for Table 5:

- Parts are tested in pulsed conditions at the rated test current (indicated in bold font), T_j = 25°C. Pulse width is 10 ms.
- Bridgelux maintains a tester tolerance of ± 0.10 V on forward voltage measurements.
- Forward voltage minimum and maximum values at the rated test current are guaranteed by 100% test. Values provided at alternative drive currents are provided for reference only and are not guaranteed by test.
- V_f Min hot and V_f max cold values are provided as reference only and are not guaranteed by test. These values are provided to aid in driver design and selection over the operating range of the product.
- Typical Coefficient of Forward Voltage tolerance of ± 10% from nominal current.

Absolute Minimum and Maximum Ratings

Table 6: Maximum Current and Reverse Voltage Ratings

Part Number	Maximum DC Forward Current (mA)	Maximum Peak Pulsed Current (mA) ^[1]	Maximum Reverse Voltage (V _r) ^[2]
BXRC-27E2000-C-03	1050	1500	-55
BXRC-27G2000-C-03	1050	1500	-55
BXRC-27H2000-C-03	1050	1500	-55
BXRC-30E2000-C-03	1050	1500	-55
BXRC-30G2000-C-03	1050	1500	-55
BXRC-30H2000-C-03	1050	1500	-55
BXRC-35E2000-C-03	1050	1500	-55
BXRC-40E2000-C-03	1050	1500	-55
BXRC-50C2000-C-04	1050	1500	-55

Notes for Table 6:

1. Bridgelux recommends a maximum duty cycle of 10% when operating LED Arrays at the maximum peak pulsed current specified. Maximum peak pulsed currents indicate values where the LED array can be driven without catastrophic failures.
2. Light emitting diodes are not designed to be driven in reverse voltage.
3. Lumen maintenance (L70) and lifetime predictions are valid for drive current and case temperature conditions used for LM-80 testing as included in the applicable LM-80 test report for these products. Vero LED arrays can be driven at higher currents but lumen maintenance may be reduced, however, the luminaire design may need to design in lower T_c values to meet lumen maintenance capabilities equal to lower drive current operations.

Table 7: Maximum Ratings

Parameter	Maximum Rating
LED Junction Temperature	150°C
Storage Temperature	-40°C to +105°C
Operating Case Temperature	105°C
Soldering Temperature ^[1]	350°C for a maximum of 10 seconds

Notes for Table 7:

1. See Bridgelux Application Note AN31, Assembly Considerations for Vero LED arrays, for more information.

Typical Forward Current Characteristics

Figure 1: Electrical Characteristics

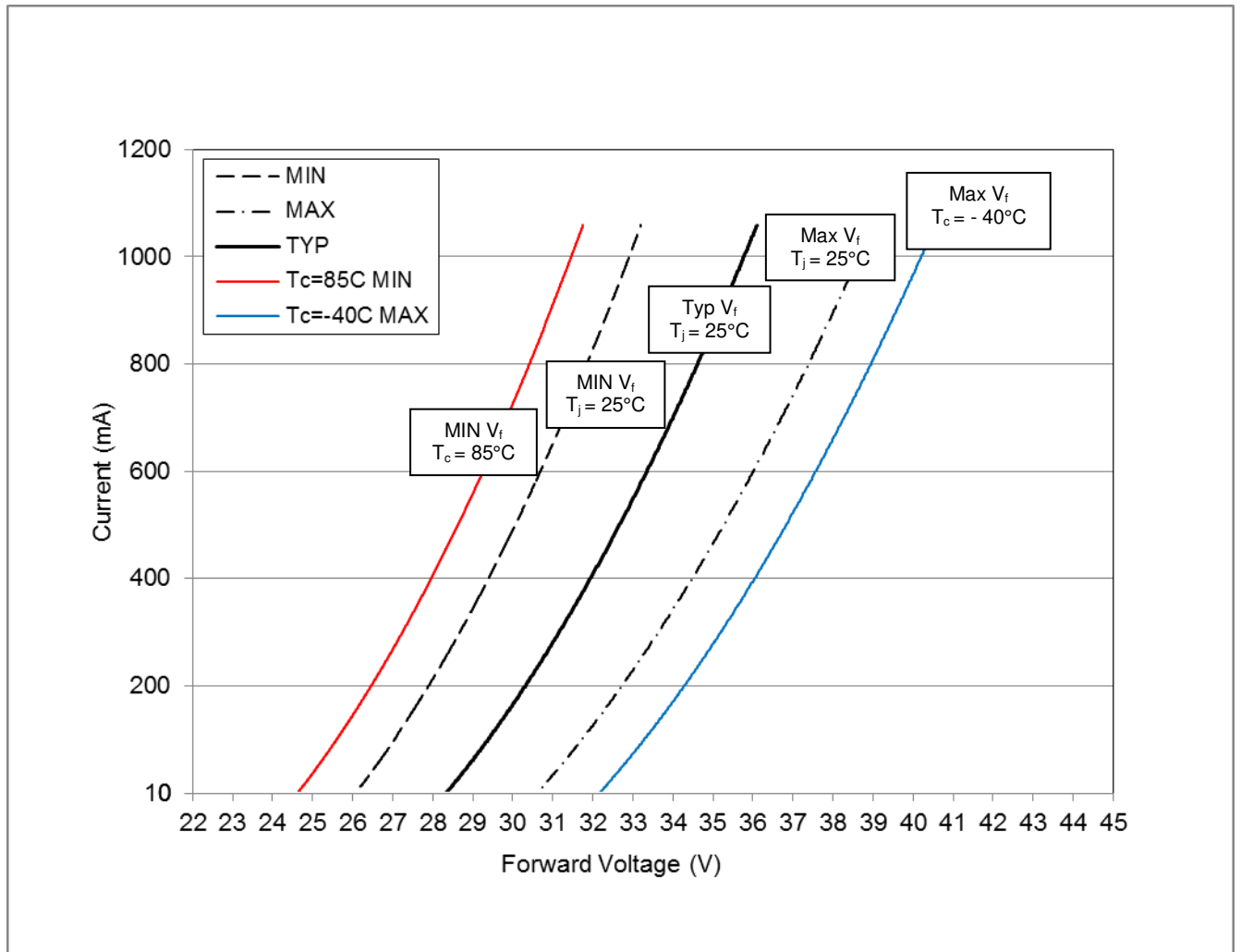

Typical Relative Luminous Flux vs. Current, $T_j=25^\circ\text{C}$

Figure 2: Typical Flux vs. Current, $T_j = 25^\circ\text{C}$

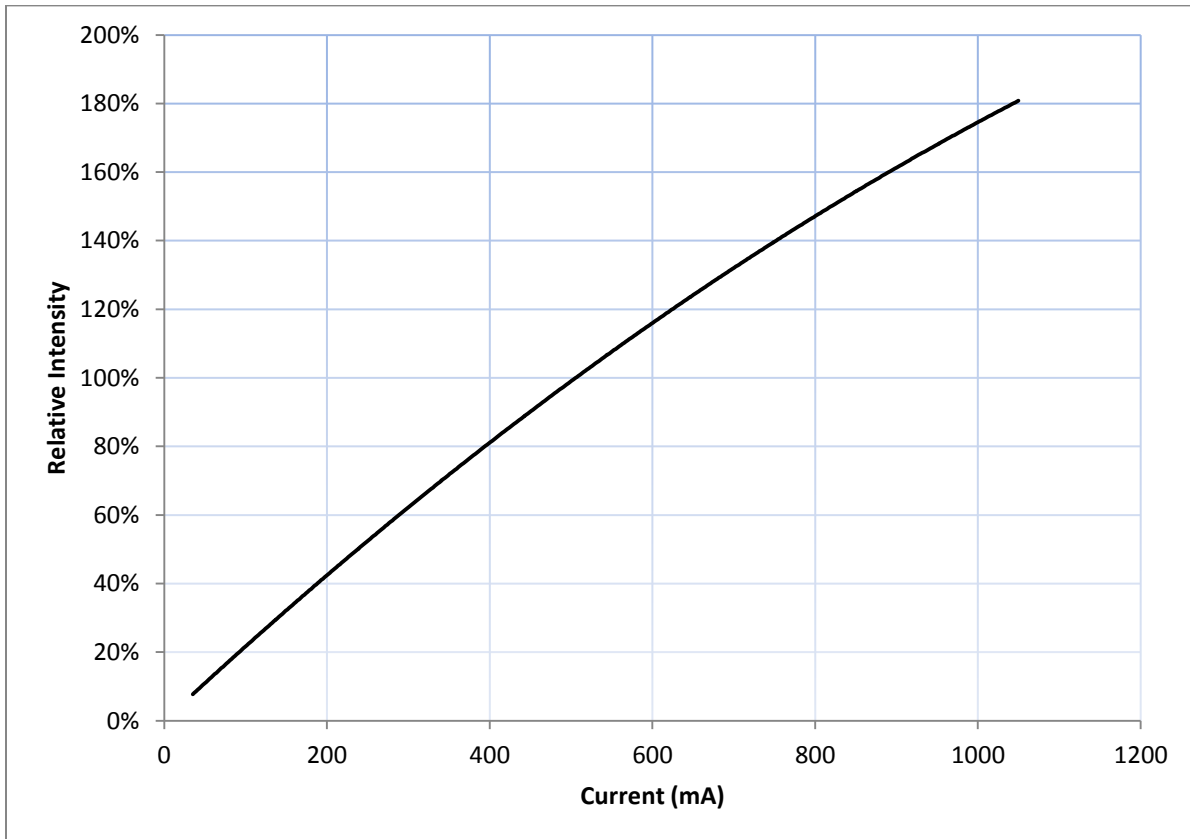

Typical Light Output Characteristics vs. Temperature

Figure 3: Typical Flux vs. Junction Temperature

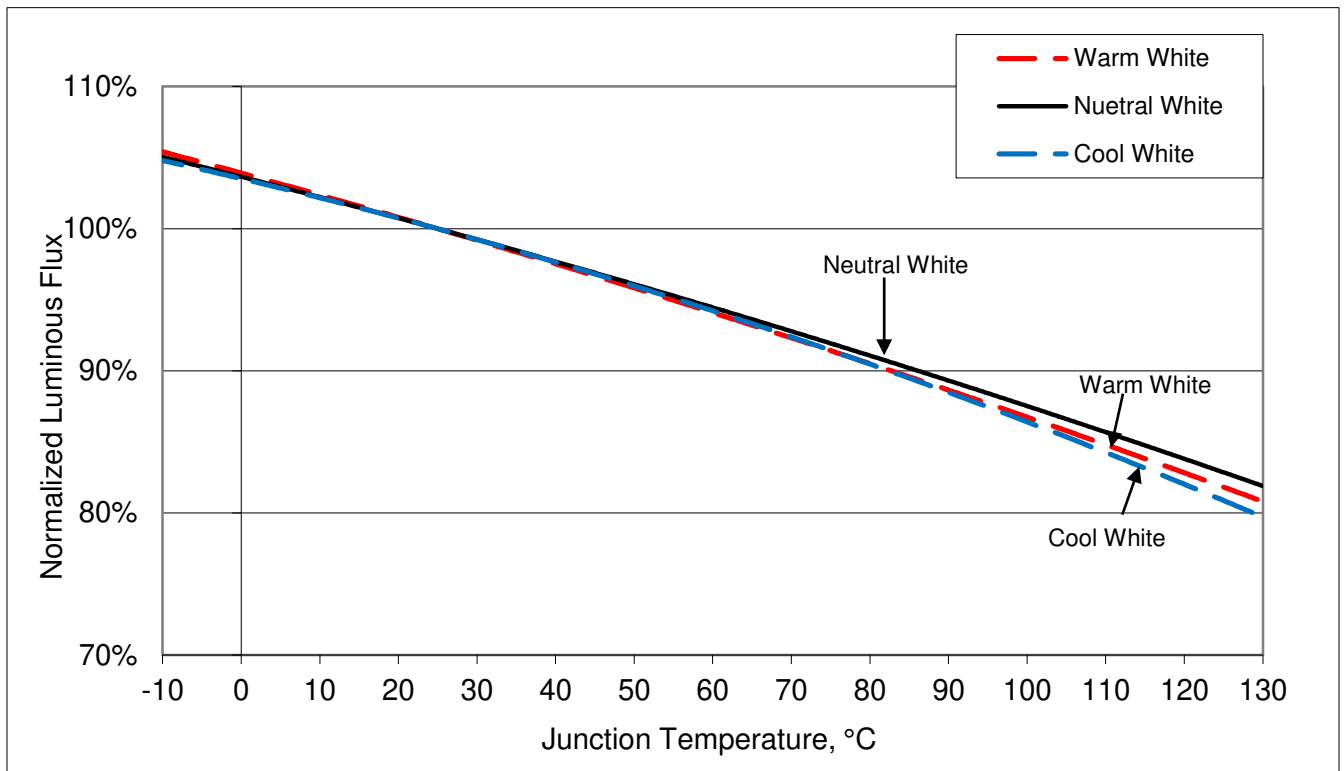

Notes for Figure 3:

1. Characteristics shown for warm white reflect 3000K 80 CRI.
2. Characteristics shown for neutral white reflect 4000K 80 CRI.
3. Characteristics shown for cool white reflect 5000K 70 CRI.

Typical Chromaticity Characteristics vs. Temperature

Figure 4: Typical ccx Shift vs. Junction Temperature

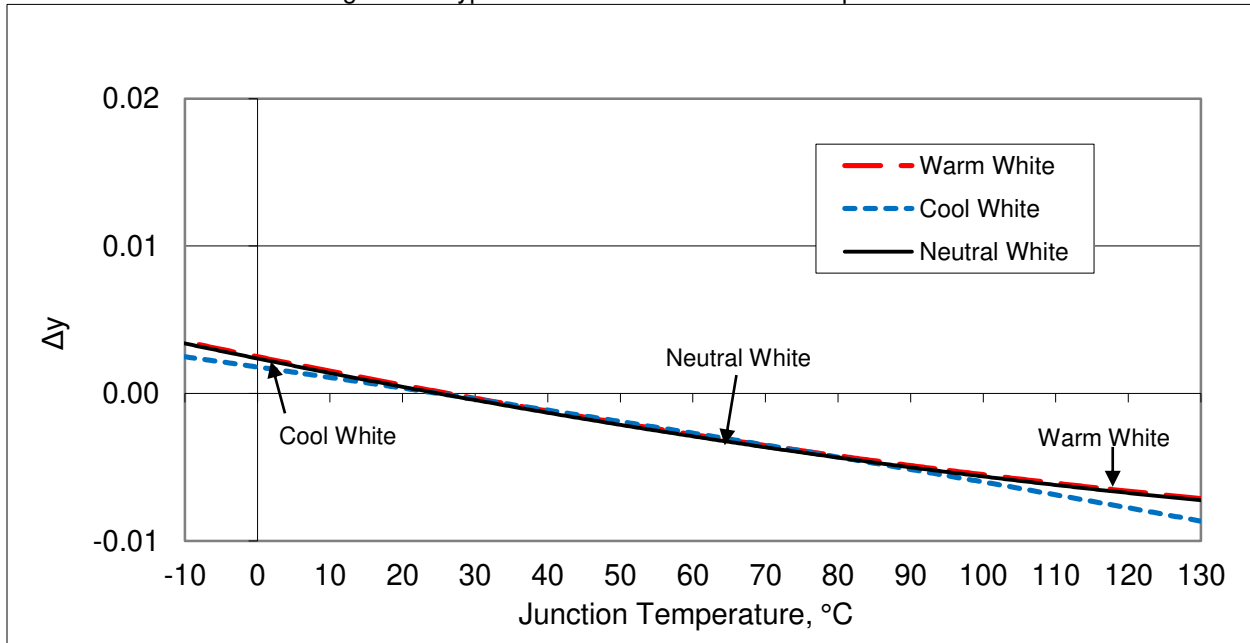
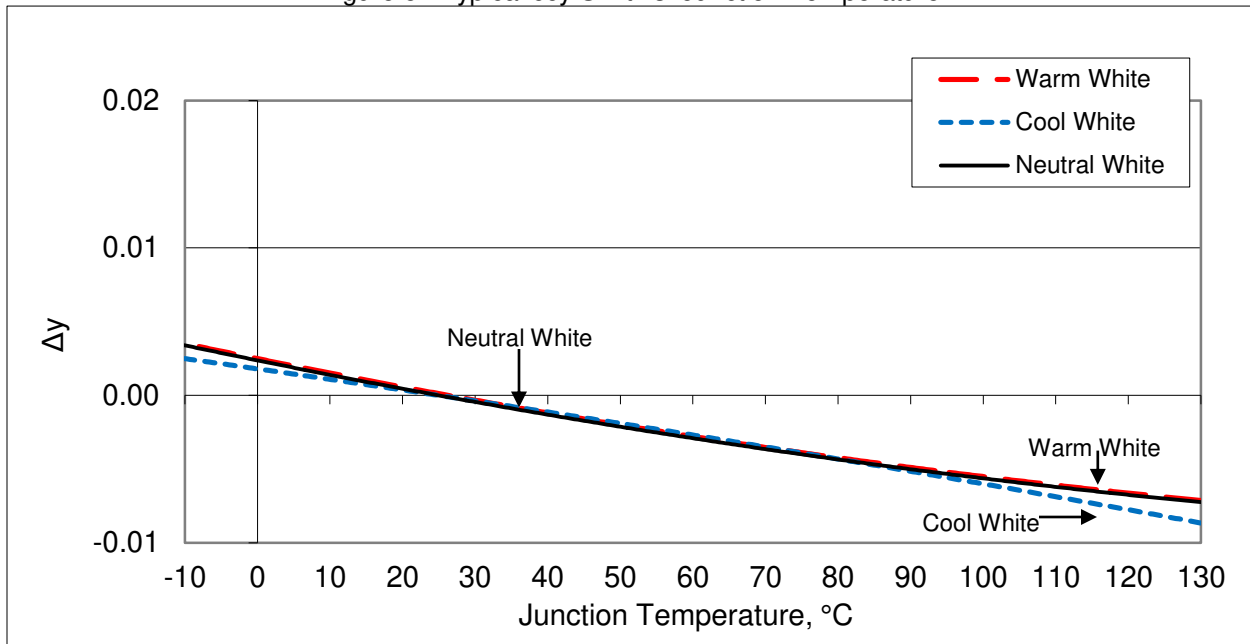

Figure 5: Typical ccy Shift vs. Junction Temperature



Notes for Figures 4 and 5:

1. Characteristics shown for warm white reflect 3000K 80 CRI.
2. Characteristics shown for neutral white reflect 4000K 80 CRI.
3. Characteristics shown for cool white reflect 5000K 70 CRI.

Figure 6: Typical Spatial Radiation Pattern

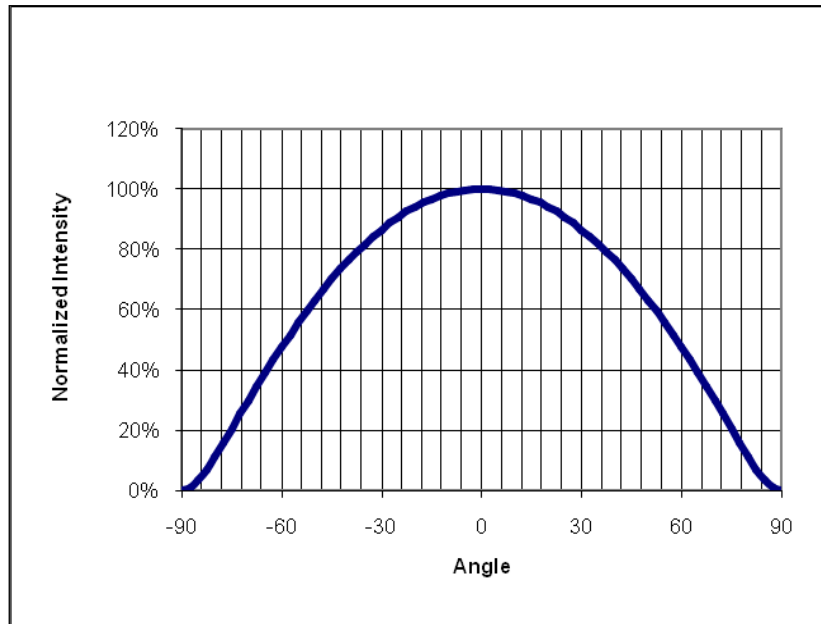

Notes for Figure 6:

1. The typical viewing angle for the Vero 13 LED arrays is 120°.
2. The viewing angle is defined as the off axis angle from the centerline where I_v is $\frac{1}{2}$ of the peak value.

Figure 7: Typical Polar Radiation Pattern

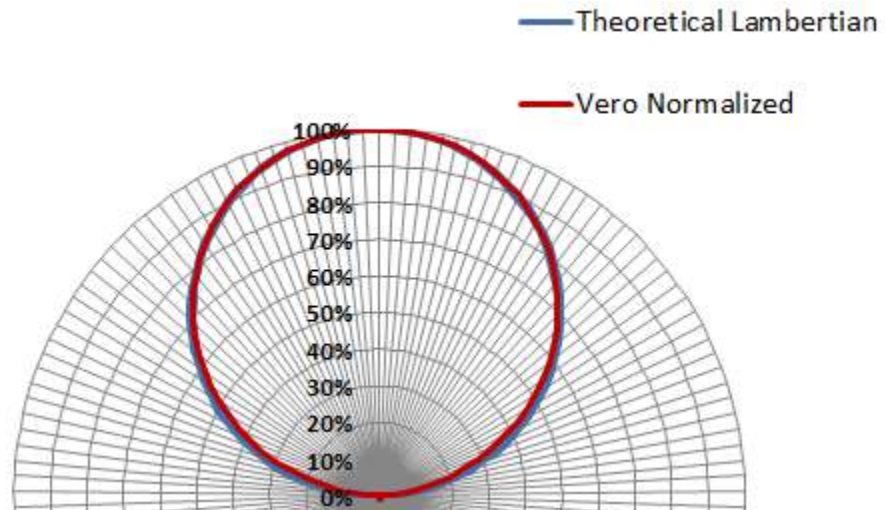

Wavelength Characteristics at Rated Test Current, $T_j=25^\circ\text{C}$

Figure 8: Typical Color Spectrum

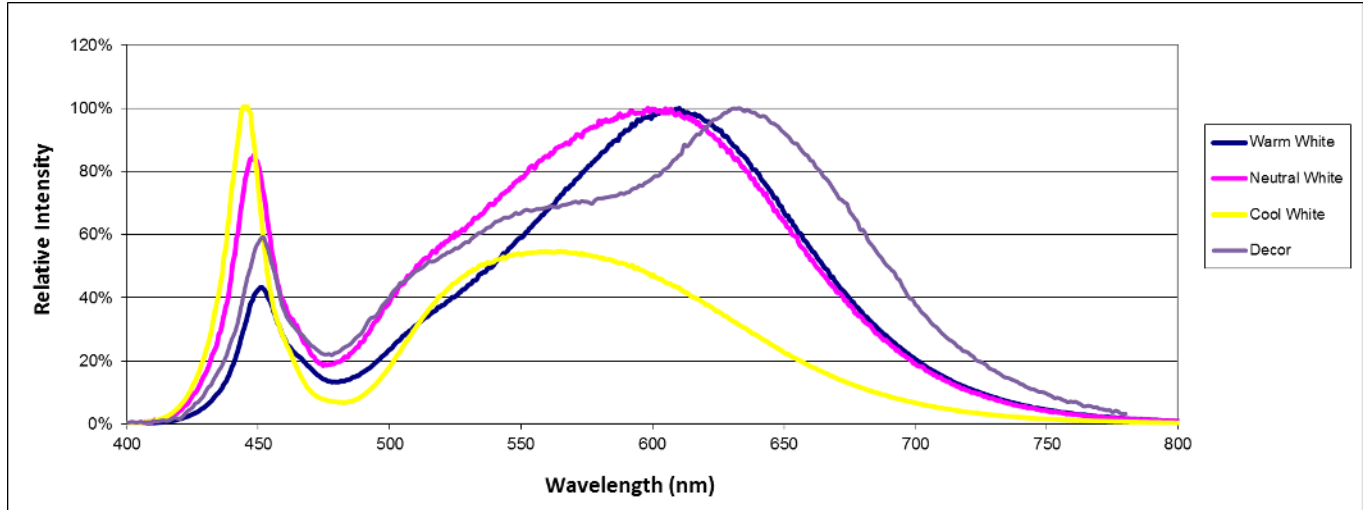

Notes for Figure 8:

1. Color spectrum shown for warm white is 3000K 80 CRI.
2. Color spectrum shown for neutral white is 4000K 80 CRI.
3. Color spectrum shown for cool white is 5000K 70 CRI.

Mechanical Dimensions

Figure 9: Drawing for Vero 13 LED Array

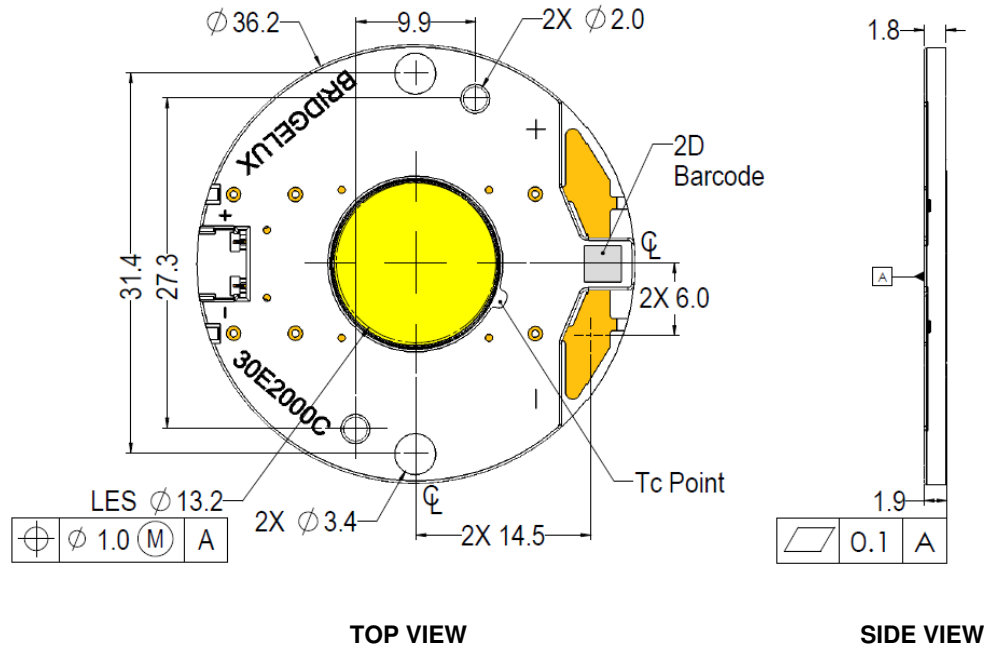

Notes for Figure 9:

1. Mounting holes (2X) are for M2.5 screws.
2. Bridgelux recommends two tapped holes for mounting screws with 31.4 ± 0.10 mm center-to-center spacing.
3. Screws with flat shoulders (pan, dome, button, round, truss, mushroom) provide optimal torque control. Do NOT use flat, countersink, or raised head screws.
4. Solder pads and connector port are labeled "+" and "-" to denote positive and negative, respectively.
5. It is not necessary to provide electrical connections to both the solder pads and the connector port. Either set may be used depending on application specific design requirements.
6. Drawings are not to scale.
7. Drawing dimensions are in millimeters.
8. Unless otherwise specified, tolerances are ± 0.10 mm.
9. Refer to Application Notes AN30 and AN31 for product handling, mounting and heat sink recommendations.
10. The optical center of the LED Array is nominally defined by the mechanical center of the array to a tolerance of ± 0.45 mm.
11. Bridgelux maintains a flatness of 0.10 mm across the mounting surface of the array.
12. Bridgelux Vero 13 LED arrays are packaged in trays of 20 units with a maximum planar dimension of 215.0 mm x 279.4 mm (8.5 x 11 inches) per tray.

Color Control Information

Figure 10: Graph of Warm White Test Bins in xy Color Space
(Pulsed Test Conditions, $T_j = 25^\circ\text{C}$)

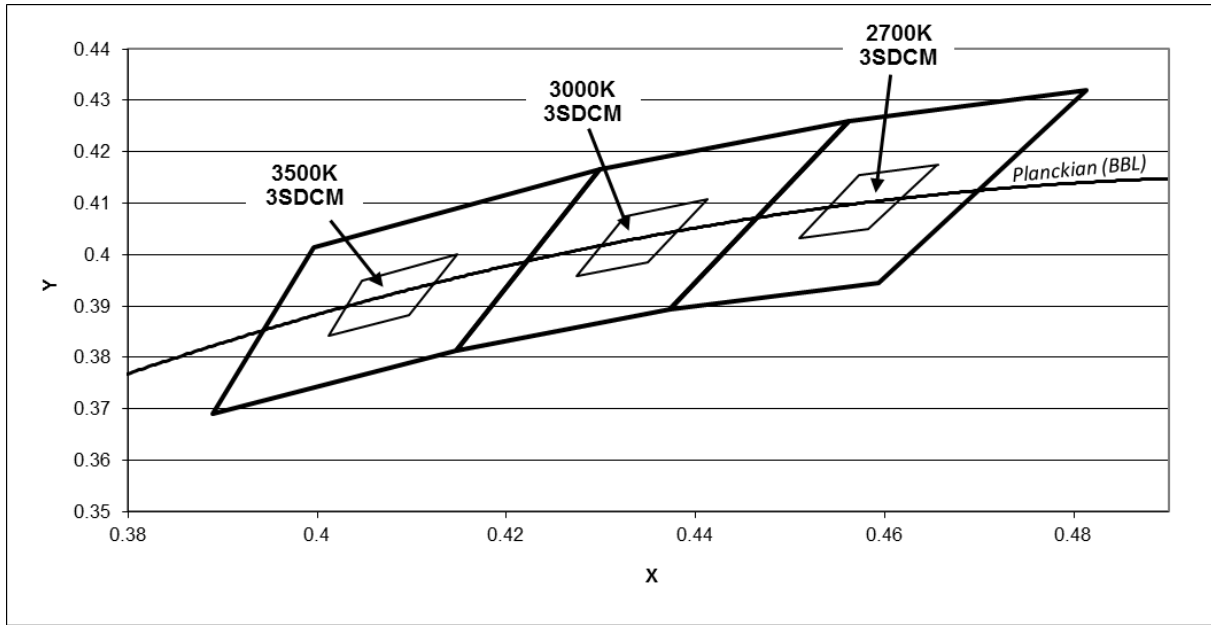

Table 10: Warm White xy Bin Coordinates and Associated Typical CCT

Bin Code	X	Y	CCT (K)
03 (3SDCM)	0.415	0.400	3500
	0.405	0.395	
	0.401	0.384	
	0.410	0.388	

Center point	0.407	0.392
--------------	-------	-------

Bin Code	X	Y	CCT (K)
03 (3SDCM)	0.441	0.411	3000
	0.433	0.408	
	0.427	0.396	
	0.435	0.398	

Center point	0.434	0.403
--------------	-------	-------

Bin Code	X	Y	CCT (K)
03 (3SDCM)	0.467	0.418	2700
	0.456	0.415	
	0.450	0.403	
	0.460	0.405	

Center point	0.458	0.410
--------------	-------	-------

Color Binning Information (continued)

Figure 11: Graph of Neutral White Test Bins in xy Color Space
(Pulsed Test Conditions, $T_j = 25^\circ\text{C}$)

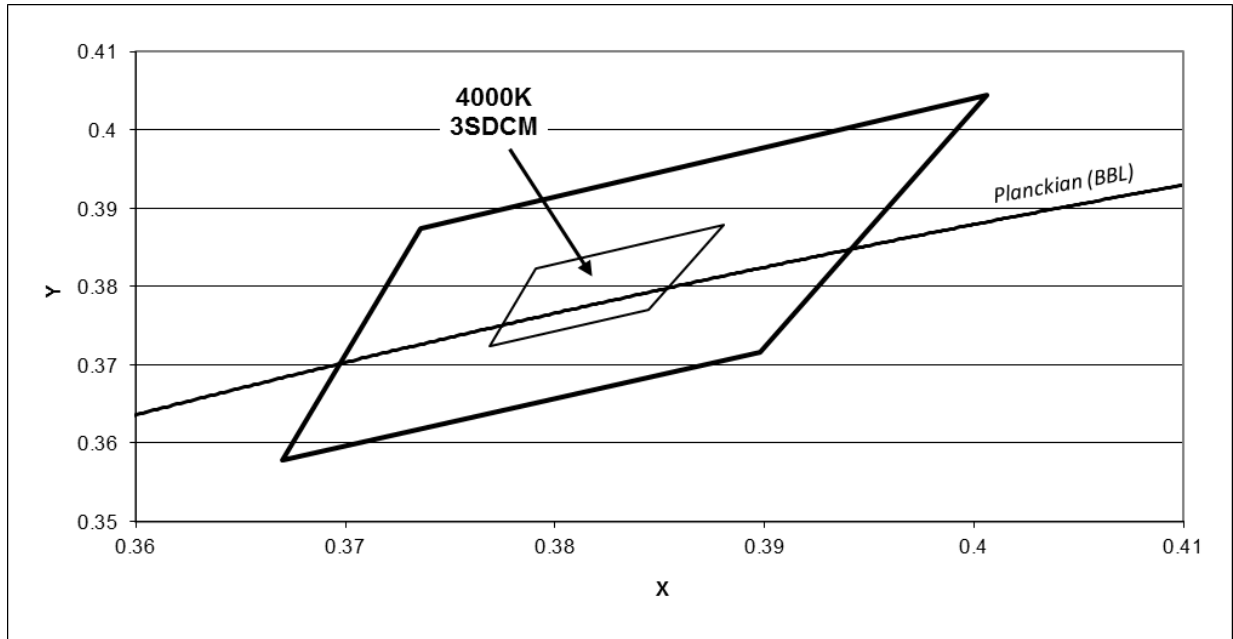

Table 11: Neutral White xy Bin Coordinates and Associated Typical CCT

Bin Code	X	Y	CCT (K)
03 3SDCM	0.388	0.388	4000
	0.379	0.382	
	0.377	0.372	
	0.385	0.377	

Center point	0.382	0.380
--------------	-------	-------

Notes for Figures 10 and 11:

1. Parts are tested in pulsed conditions, $T_j = 25^\circ\text{C}$. Pulse width is 10 ms at rated test current.
2. Typical stabilized DC performance values are provided as reference only and are not a guarantee of performance.
3. Typical performance when driven at DC (direct current) test current with LED array case temperature maintained at 85°C , mounted to heat sink with thermal interface material. Please contact a Bridgelux sales representative for additional details.

Color Binning Information (continued)

Figure 12: Graph of Cool White Test Bins in xy Color Space
(Pulsed Test Conditions, $T_j = 25^\circ\text{C}$)

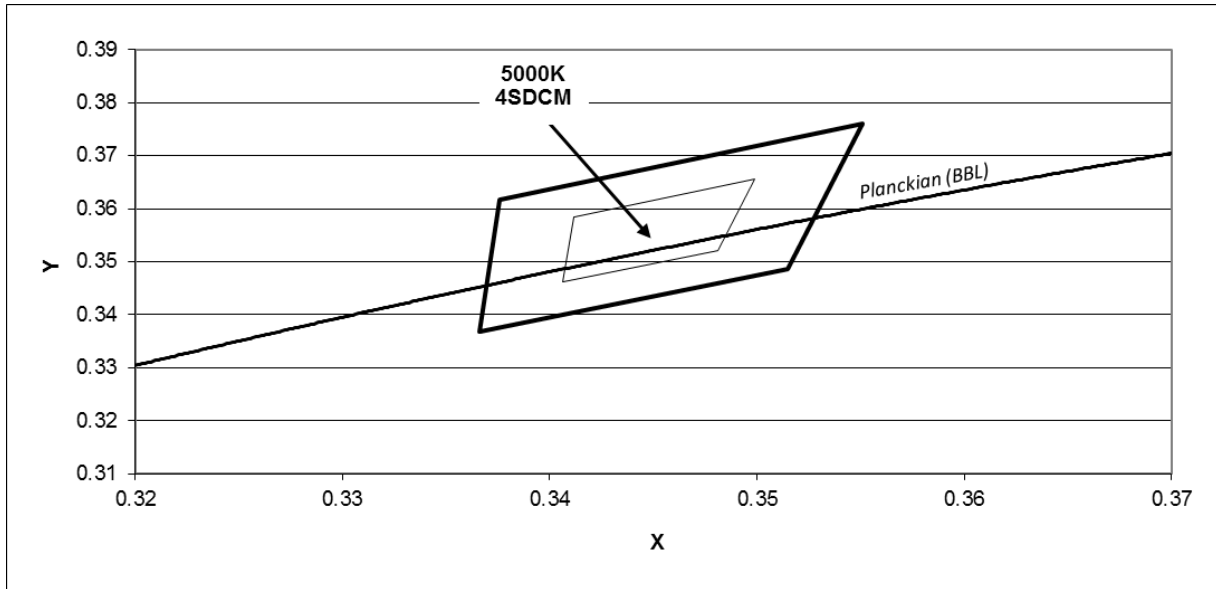

Table12: Cool White xy Bin Coordinates and Associated Typical CCT

Bin Code	X	Y	CCT (K)
04	0.350	0.366	5000
4SDCM	0.341	0.359	
	0.341	0.346	
	0.348	0.352	
Center point	0.345	0.355	

Design Resources

Bridgelux is developing a comprehensive set of application notes and design resources to assist customers in successfully designing with the Vero product family of LED array products. Included below is a list of resources under development which will be downloaded from the Bridgelux web site under the Design Resources section.

Application Notes

- AN30: Effective Thermal Management of BridgeluxVero LED Arrays
- AN31: Assembly Considerations for BridgeluxVeroLED Arrays
- AN32: Electrical Drive Considerations for Bridgelux Vero LED Arrays
- AN34: Reliability Data Sheet for Bridgelux Vero LED Arrays
- AN36: Optical Considerations for Bridgelux Vero LED Arrays

Optical Source Models

Optical source models and ray set files are available for all BridgeluxVero LED array products. The list below contains the formats currently available. If you require a specific format not included in this list, please contact your Bridgelux sales representative for assistance.

- Zemax
- ASAP
- IESNA
- LightTools
- LucidShape
- OPTIS SPEOS
- PHOTOPIA
- TracePro
- Radiant Imaging Source Model

3D CAD Models

Three dimensional CAD models depicting the product outline of all Bridgelux Vero LED arrays are available in both SAT and STEP formats. Please contact your Bridgelux sales representative for assistance.

About Bridgelux

Bridgelux is a leading developer and manufacturer of technologies and solutions transforming the \$40 billion global lighting industry into a \$100 billion market opportunity. Based in Livermore, California, Bridgelux is a pioneer in solid-state lighting (SSL), expanding the market for light-emitting diode (LED) technologies by driving down the cost of LED lighting systems. Bridgelux's patented light source technology replaces traditional technologies (such as incandescent, halogen, fluorescent and high intensity discharge lighting) with integrated, solid-state lighting solutions that enable lamp and luminaire manufacturers to provide high performance and energy-efficient white light for the rapidly growing interior and exterior lighting markets, including street lights, commercial lighting and consumer applications. With more than 550 patent applications filed or granted worldwide, Bridgelux is the only vertically integrated LED manufacturer and developer of solid-state light sources that designs its solutions specifically for the lighting industry.

For more information about the company, please visit www.bridgelux.com

© 2013 Bridgelux, Inc. All rights reserved. Product specifications are subject to change without notice.

