



soberton inc.

ELECTRO MAGNETIC BUZZER

Acoustic Product Specification

Product Number: WST-0904T



Release | Revision: A/2022

CONTENTS

This document contains the technical specifications for the electromagnetic buzzer with built-in oscillating circuit.

Page 1
Specifications

Dimensions

Page 2
Reliability Test

Page 3
Electrical and Acoustical
Measuring Condition

Recommended Wave Soldering
Temperature

Page 4
Packing

Specifications

Item	Unit	Specifications
Rated Voltage	VDC	3
Operating Voltage	VDC	2 ~ 5
Rated Current	mA	Max. 30 at 3 VDC
Sound Output	dB	Min. 80 at 3 VDC, 10cm
Tone		Continuous
Resonant Frequency	Hz	2700±300
Operating Temperature	°C	-20 ~ +70
Storage Temperature	°C	-30 ~ +80
Dimensions	mm	Φ9.2 × H4.2
Pin Length	mm	L1= 4.0±0.5, L2= 5.5±0.5, Φ=0.6±0.1
Housing Material		Black PBT
Net Weight	gram	Approx. 1.0
Terminal		Pin Type
Environmental Protection Regulation		RoHS 2.0

Measuring Condition:

Temperature: 5~35°C Humidity: 45%~85%R.H Atmospheric Pressure: 860 ~1060hPa

Dimensions

Unit mm

Tolerance ±0.5mm, except where specified

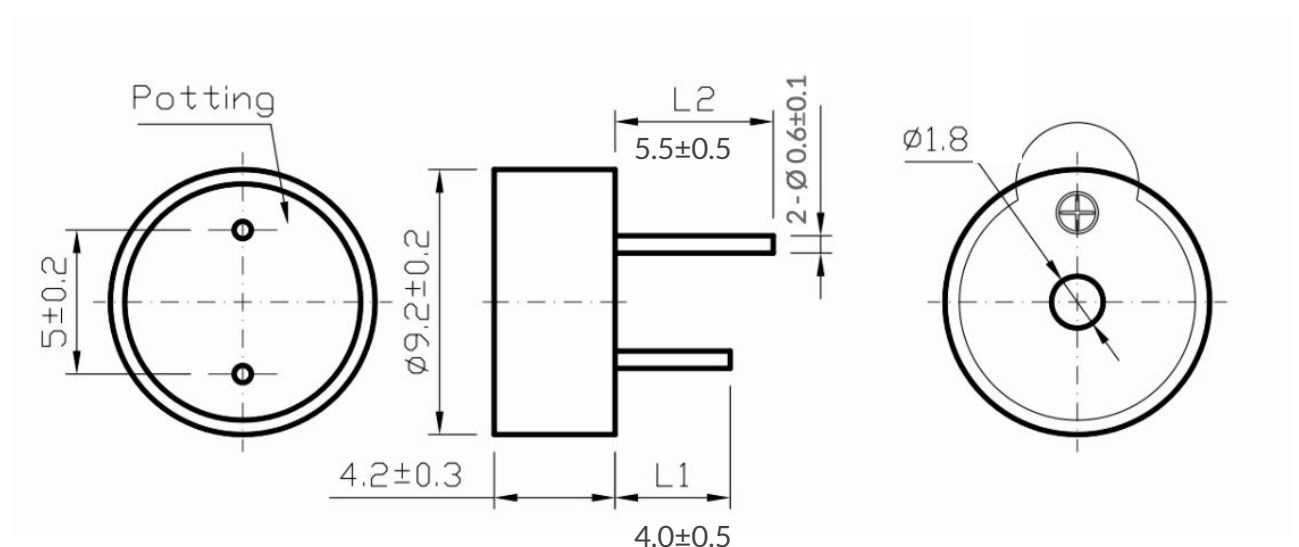

Housing Material: Black PBT



soberton inc.

ELECTRO MAGNETIC BUZZER

Acoustic Product Specification

Product Number: WST-0904T



Release | Revision: A/2022

CONTENTS

This document contains the technical specifications for the electromagnetic buzzer with built-in oscillating circuit.

Page 1

Specifications

Dimensions

Page 2

Reliability Test

Page 3

Electrical and Acoustical
Measuring Condition

Recommended Wave Soldering
Temperature

Page 4

Packing

Reliability Test

After any of the following tests the part shall meet specifications without any degradation in appearance and performance except SPL. SPL shall meet the specifications and shall not deviate more than -10dB from the initial value.

Standard Temperature Life Test

The part shall be subjected to 96 hours at $25\pm 10^{\circ}\text{C}$.

Input rated voltage: 3 VDC

Resonant frequency: 2700Hz, 50% duty cycle, square wave.

High Temperature Test

The part shall be capable of withstanding a storage temperature of $+80^{\circ}\text{C}$ for 96 hours.

Low Temperature Test

The part shall be capable of withstanding a storage temperature of -30°C for 96 hours.

Humidity Test

Temperature $+40^{\circ}\text{C}\pm 3^{\circ}\text{C}$

Relative Humidity 90% ~ 95%

Duration 48 hours and exposure to room temperature for 6 hours

Temperature Shock Test

Per cycle

70°C / 1 hour \rightarrow 25°C / 3 hours \rightarrow -30°C / 1 hour \rightarrow 25°C / 3 hours

Total cycle 10 cycles

Drop Test

Standard Packaging from 1.2m

Drop on hardwood or board of 5cm thick, three sides, six plain

Vibration Test

Vibration 1000 cycles/min.

Amplitude 1.5mm

Duration 1 hour in each 3 axes

Note

Please make sure that any foreign materials (e.g. magnetic powder, washing solvent, flux, corrosive gas) do not enter this product in your production processes. Contamination may result in a loss of some or all audio output.



soberton inc.

ELECTRO MAGNETIC BUZZER

Acoustic Product Specification

Product Number: WST-0904T



Release | Revision: A/2022

CONTENTS

This document contains the technical specifications for the electromagnetic buzzer with built-in oscillating circuit.

Page 1
Specifications

Dimensions

Page 2
Reliability Test

Page 3
Electrical and Acoustical
Measuring Condition

Recommended Wave Soldering
Temperature

Page 4
Packing

Electrical and Acoustical Measuring Condition

Recommended Test Circuit

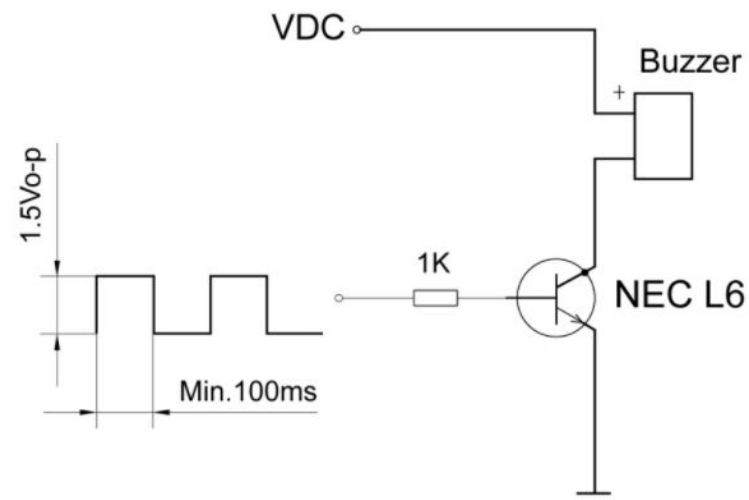

Recommended Setting

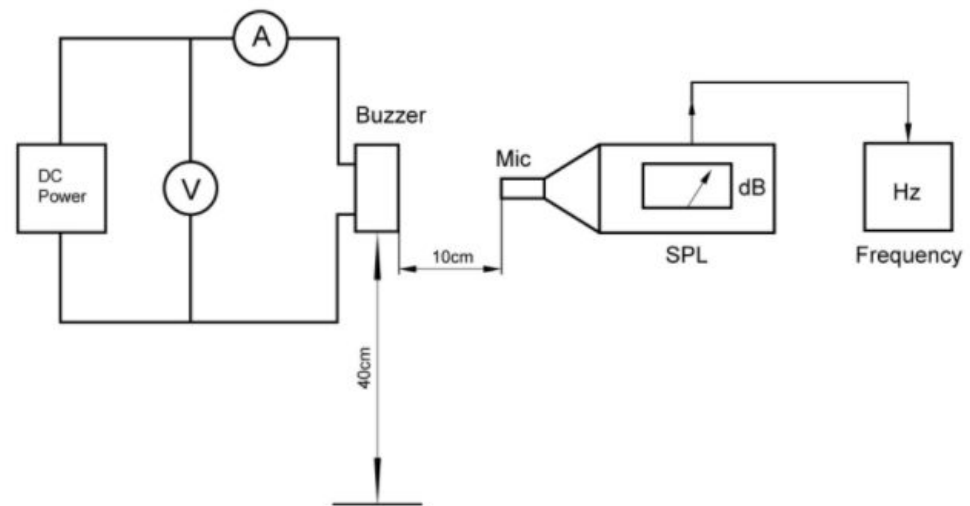

Recommended Wave Soldering Temperature

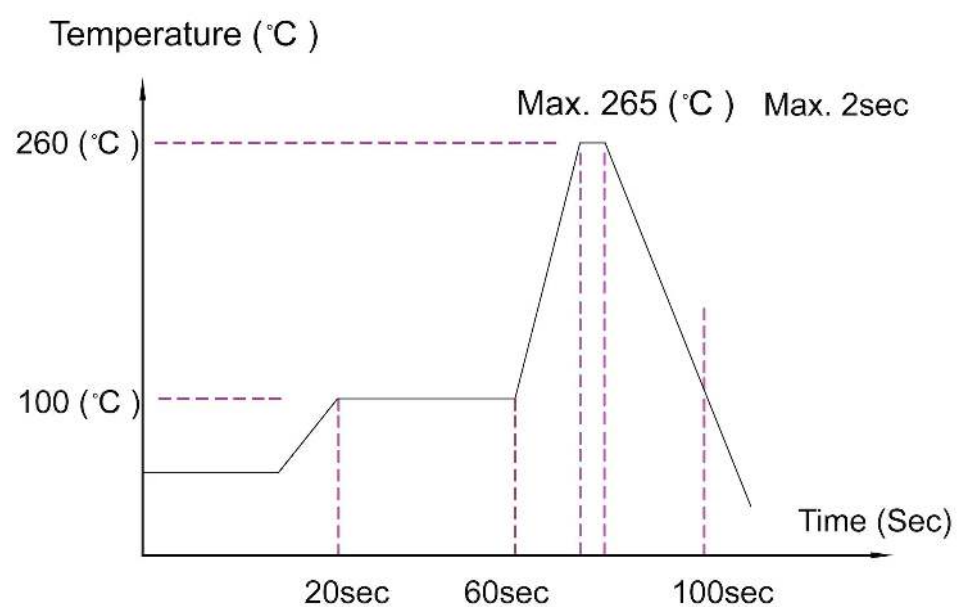



soberton inc.

ELECTRO MAGNETIC BUZZER

Acoustic Product Specification

Product Number: WST-0904T



Release | Revision: A/2022

CONTENTS

This document contains the technical specifications for the electromagnetic buzzer with built-in oscillating circuit.

Page 1

Specifications

Dimensions

Page 2

Reliability Test

Page 3

Electrical and Acoustical
Measuring Condition

Recommended Wave Soldering
Temperature

Page 4

Packing

Packing

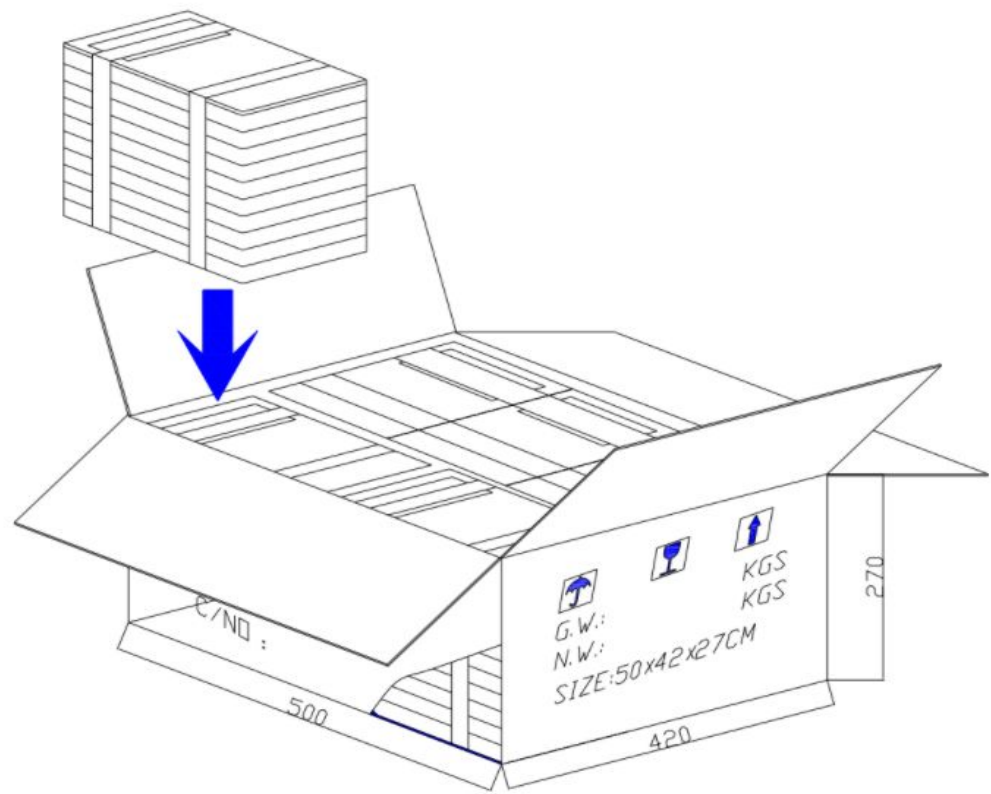
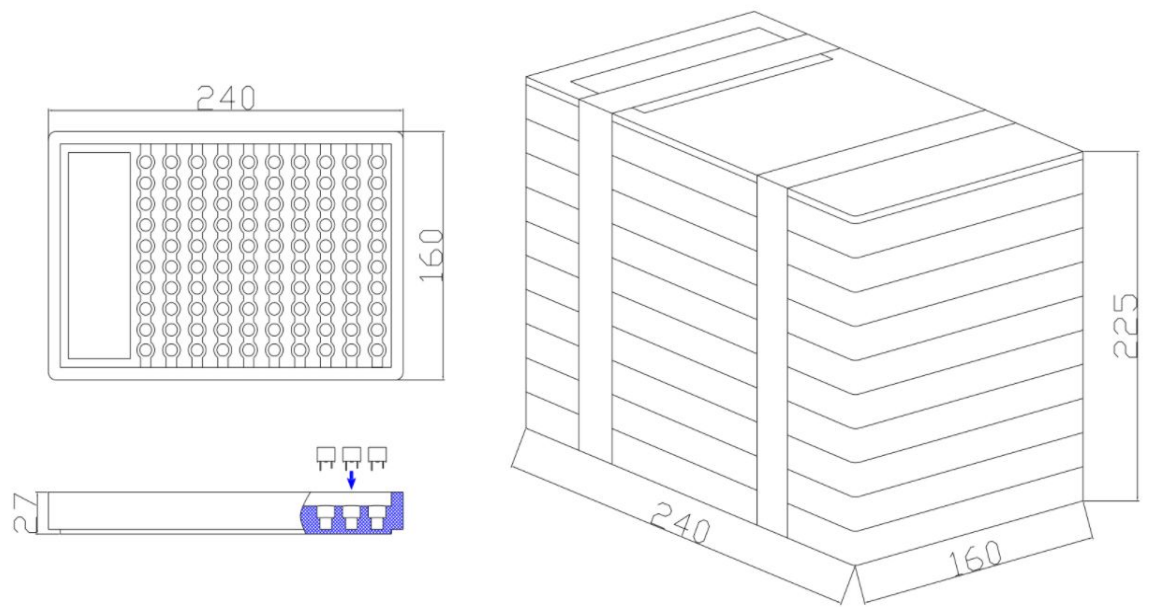

Packing Method	Quantity (pc)	Measurement (mm)
Per Tray	100	240x160x27
Bundle	1000	240x160x225
Carton	5000	500x420x270