

Multiband GNSS (GPS/GLONASS) External Antenna



AEACBD045015-SG2



45.2 x 35.8 x 15.2 mm
RoHS/RoHS II Compliant
 MSL = N/A: Not Applicable

Features

- Multiband GPS/GLONASS antenna
- Active GNSS with LNA and filter
- LNA gain of 28 dB
- RHCP polarization
- IP67 rated
- Magnetic mounting

Applications

- GPS/GLONASS applications
- IoT
- M2M
- Surveillance
- Fleet management and asset tracking
- Autonomous driving
- Telematics
- Agriculture
- Instrumentation
- Survey

Electrical Specifications

Antenna

Parameters	Min.	Typ.	Max.	Units	Notes
Operating Frequency	1575.42		1602	MHz	
VSWR			1.5		
Gain		5		dBic	Zenith
Axial Ratio			3	dB	
Impedance		50		Ω	
Polarization		RHCP			

LNA

Parameters	Min.	Typ.	Max.	Units	Notes
LNA Gain		28 ± 2		dB	
Noise Figure			1.5	dB	Typ. @ 25°C
Filter Insertion Loss			3	dB	
Ex-Band Attenuation		12		dB	CF + 50 MHz
		16			CF - 50 MHz
VSWR			2		
Supply Voltage	2.2		5	V	DC
Current Consumption	5		15	mA	
Impedance		50		Ω	

Multiband GNSS (GPS/GLONASS) External Antenna



AEACBD045015-SG2



45.2 x 35.8 x 15.2 mm
RoHS/RoHS II Compliant
MSL = N/A: Not Applicable

Mechanical Specifications

Parameters	Description
Cable Type	RG-174
Cable Length	3 m
Connector	SMA
Radome Material	ABS
Mounting Type	Magnet

Environmental Specifications

Parameters	Description
Operating Temperature	-40 °C to +85 °C
Relative Humidity	Up to 95 %
Ingress Protection	IP67
Vibration	10 ~ 55 Hz with 1.5 mm amplitude 2 hours

Multiband GNSS (GPS/GLONASS) External Antenna



AEACBD045015-SG2



45.2 x 35.8 x 15.2 mm
RoHS/RoHS II Compliant
MSL = N/A: Not Applicable

Product Dimensions

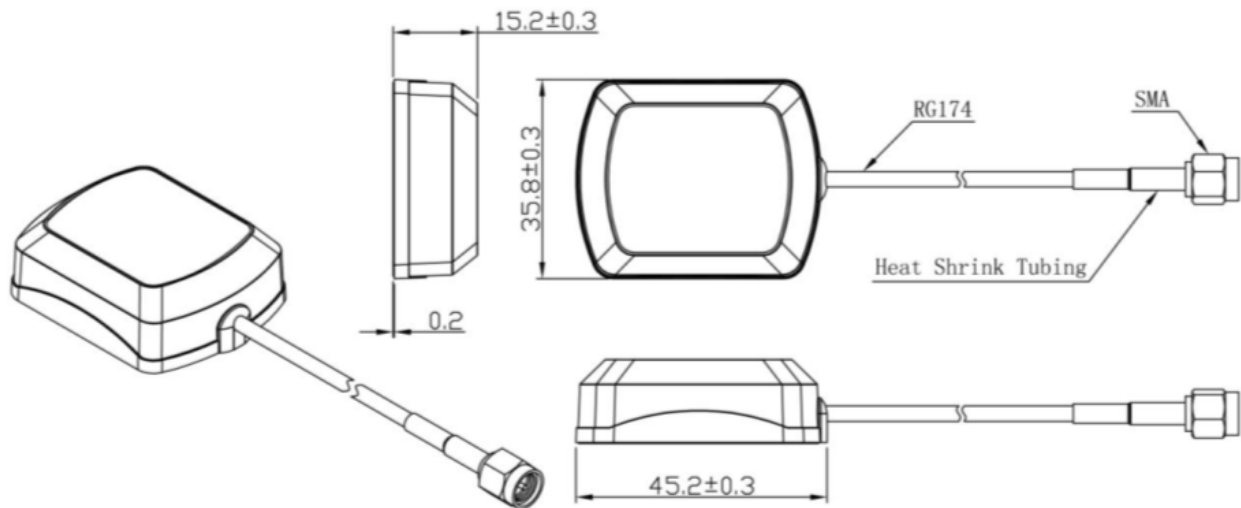

UNIT: mm

Multiband GNSS (GPS/GLONASS) External Antenna



AEACBD045015-SG2



45.2 x 35.8 x 15.2 mm
RoHS/RoHS II Compliant
MSL = N/A: Not Applicable

Return Loss

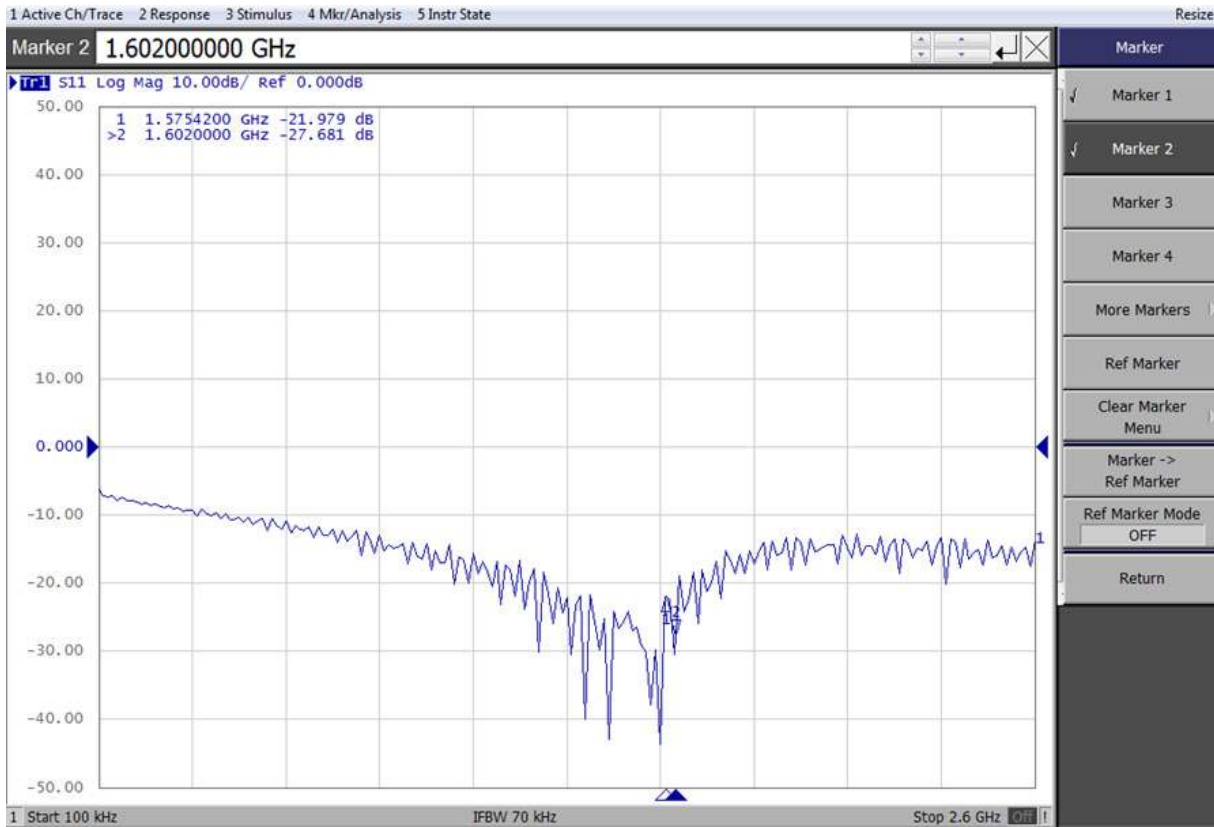

Multiband GNSS (GPS/GLONASS) External Antenna



AEACBD045015-SG2



45.2 x 35.8 x 15.2 mm
RoHS/RoHS II Compliant
MSL = N/A: Not Applicable

Radiation Pattern

2D - Pattern

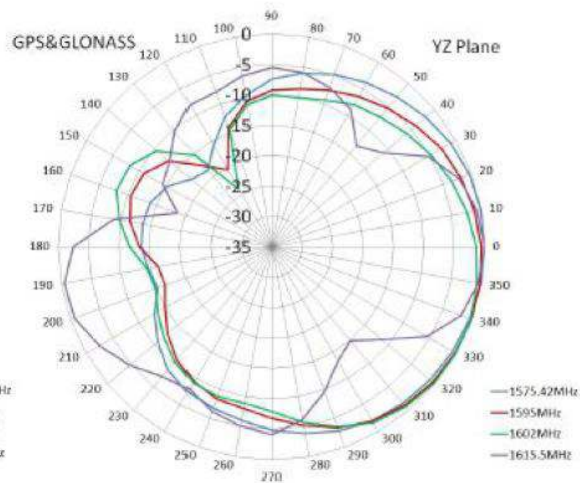
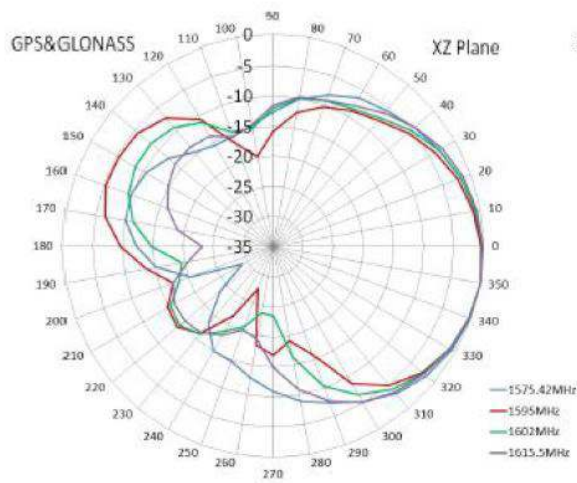
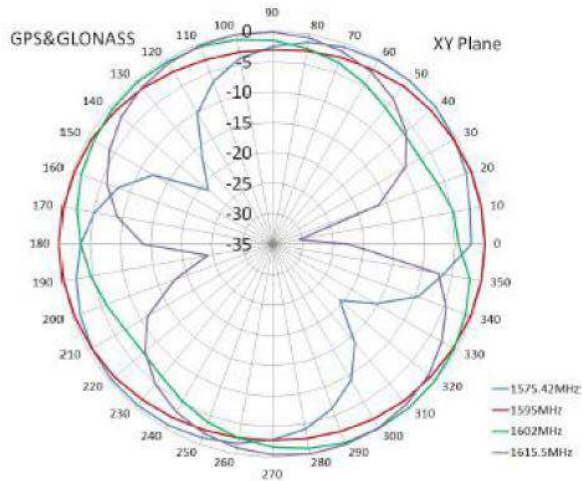

Multiband GNSS (GPS/GLONASS) External Antenna



AEACBD045015-SG2



45.2 x 35.8 x 15.2 mm
RoHS/RoHS II Compliant
MSL = N/A: Not Applicable

Radiation Pattern

3D - Pattern

1575 MHz

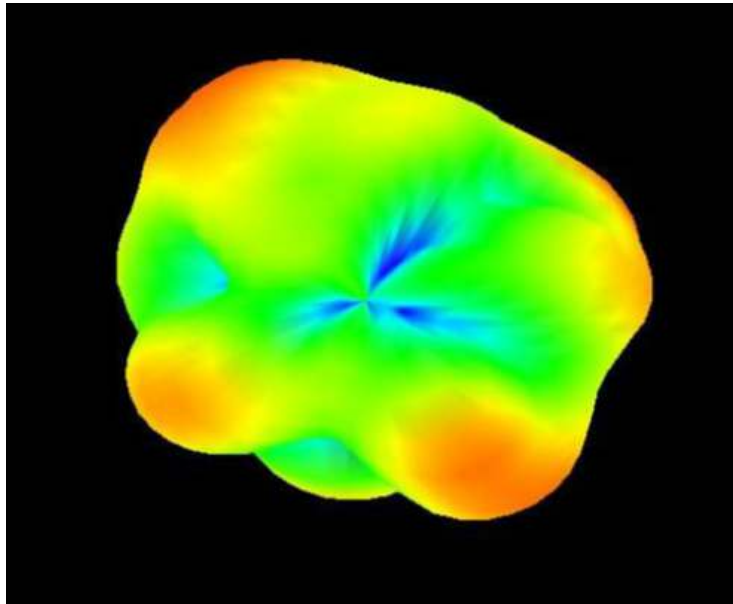

1602 MHz

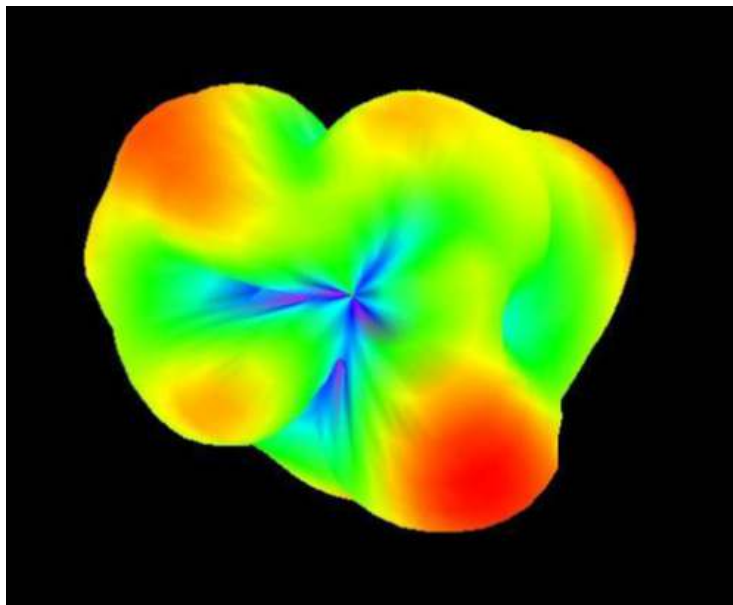

Multiband GNSS (GPS/GLONASS) External Antenna



AEACBD045015-SG2



45.2 x 35.8 x 15.2 mm
RoHS/RoHS II Compliant
MSL = N/A: Not Applicable

Packaging

A carton holds 200 pcs of antenna. Each carton is of dimension 49 x 23 x 27 cm and weighs 14 Kg.

ATTENTION: Abracon LLC's products are COTS – Commercial-Off-The-Shelf products; suitable for Commercial, Industrial and, where designated, Automotive Applications. Abracon's products are not specifically designed for Military, Aviation, Aerospace, Life-dependent Medical applications or any application requiring high reliability where component failure could result in loss of life and/or property. For applications requiring high reliability and/or presenting an extreme operating environment, written consent and authorization from Abracon LLC is required. Please contact Abracon LLC for more information.



5101 Hidden Creek Ln Spicewood TX 78669
Phone: 512-371-6159 | Fax: 512-351-8858
For terms and conditions of sales, please visit:
www.abracon.com

REVISED: 06-20-19

ABRACON IS
ISO9001-2015
CERTIFIED