

## DRV425 Fluxgate Magnetic-Field Sensor

### 1 Features

- High-Precision, Integrated Fluxgate Sensor:
  - Offset:  $\pm 8 \mu\text{T}$  (Max)
  - Offset Drift:  $\pm 5 \text{ nT}/^\circ\text{C}$  (Typ)
  - Gain Error: 0.04% (Typ)
  - Gain Drift:  $\pm 7 \text{ ppm}/^\circ\text{C}$  (Typ)
  - Linearity:  $\pm 0.1\%$
  - Noise:  $1.5 \text{ nT}/\sqrt{\text{Hz}}$  (Typ)
- Sensor Range:  $\pm 2 \text{ mT}$  (Max)
  - Range and Gain Adjustable with External Resistor
- Selectable Bandwidth: 47 kHz or 32 kHz
- Precision Reference:
  - Accuracy: 2% (max), Drift: 50 ppm/ $^\circ\text{C}$  (max)
  - Pin-Selectable Voltage: 2.5 V or 1.65 V
  - Selectable Ratiometric Mode:  $V_{\text{DD}} / 2$
- Diagnostic Features: Overrange and Error Flags
- Supply Voltage Range: 3.0 V to 5.5 V

### 2 Applications

- Linear Position Sensing
- Current Sensing in Busbars
- Over-the-Trace Current Sensing
- General-Purpose Magnetic-Field Sensors
- Overcurrent Detection
- Motor Reliability Diagnostics
- Frequency and Voltage Inverters
- Solar Inverters

### 3 Description

The DRV425 is designed for single-axis magnetic field-sensing applications and enables electrically-isolated, high-sensitivity, and precise dc- and ac-field measurements. The device provides the unique and proprietary, integrated fluxgate sensor (IFG) with an internal compensation coil to support a high-accuracy sensing range of  $\pm 2 \text{ mT}$  with a measurement bandwidth of up to 47 kHz. The low offset, offset drift, and noise of the sensor, combined with the precise gain, low gain drift, and very low nonlinearity provided by the internal compensation coil, result in unrivaled magnetic field measurement precision. The output of the DRV425 is an analog signal proportional to the sensed magnetic field.

The DRV425 offers a complete set of features, including an internal difference amplifier, on-chip precision reference, and diagnostic functions to minimize component count and system-level cost.

The DRV425 is available in a thermally-enhanced, non-magnetic, thin WQFN package with a PowerPAD™ for optimized heat dissipation, and is specified for operation over the extended industrial temperature range of  $-40^\circ\text{C}$  to  $+125^\circ\text{C}$ .

#### Device Information (1)

PART NUMBER	PACKAGE	BODY SIZE (NOM)
DRV425	WQFN (20)	4.00 mm x 4.00 mm

(1) For all available packages, see the orderable addendum at the end of the data sheet.

#### Simplified Schematic

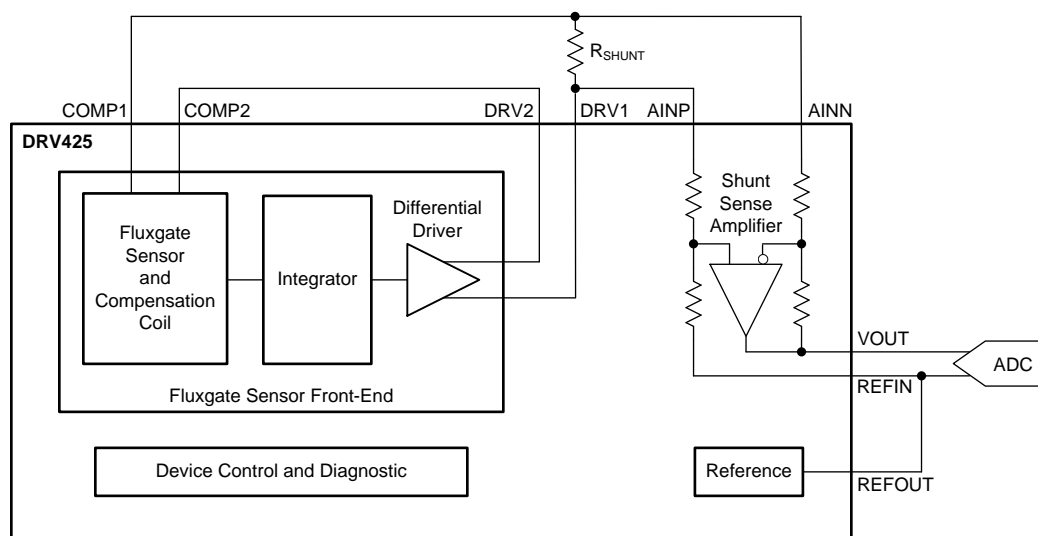

## Table of Contents

<b>1 Features</b> .....	<b>1</b>	<b>8 Application and Implementation</b> .....	<b>24</b>
<b>2 Applications</b> .....	<b>1</b>	8.1 Application Information.....	24
<b>3 Description</b> .....	<b>1</b>	8.2 Typical Applications .....	24
<b>4 Revision History</b> .....	<b>2</b>	<b>9 Power-Supply Recommendations</b> .....	<b>29</b>
<b>5 Pin Configuration and Functions</b> .....	<b>3</b>	9.1 Power-Supply Decoupling.....	29
<b>6 Specifications</b> .....	<b>4</b>	9.2 Power-On Start-Up and Brownout .....	29
6.1 Absolute Maximum Ratings .....	4	9.3 Power Dissipation .....	29
6.2 ESD Ratings.....	4	<b>10 Layout</b> .....	<b>30</b>
6.3 Recommended Operating Conditions.....	4	10.1 Layout Guidelines .....	30
6.4 Thermal Information .....	4	10.2 Layout Example .....	31
6.5 Electrical Characteristics.....	5	<b>11 Device and Documentation Support</b> .....	<b>32</b>
6.6 Typical Characteristics.....	7	11.1 Documentation Support .....	32
<b>7 Detailed Description</b> .....	<b>17</b>	11.2 Community Resources.....	32
7.1 Overview .....	17	11.3 Trademarks .....	32
7.2 Functional Block Diagram .....	17	11.4 Electrostatic Discharge Caution.....	32
7.3 Feature Description.....	18	11.5 Glossary .....	32
7.4 Device Functional Modes.....	23	<b>12 Mechanical, Packaging, and Orderable Information</b> .....	<b>32</b>

## 4 Revision History

NOTE: Page numbers for previous revisions may differ from page numbers in the current version.

<b>Changes from Original (October 2015) to Revision A</b>	<b>Page</b>
• Repaired broken links.....	1
• Added last four Applications bullets .....	1
• Changed device name in <a href="#">Figure 63</a> .....	21

## 5 Pin Configuration and Functions

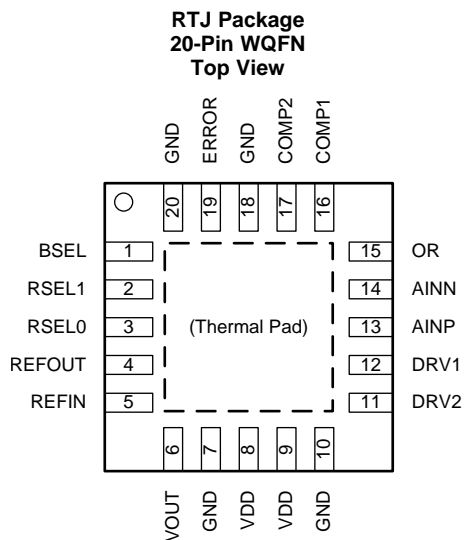

### Pin Functions

PIN		I/O	DESCRIPTION
NAME	NO.		
AINN	14	I	Inverting input of the shunt-sense amplifier
AINP	13	I	Noninverting input of the shunt-sense amplifier
BSEL	1	I	Filter bandwidth select input
COMP1	16	I	Internal compensation coil input 1
COMP2	17	I	Internal compensation coil input 2
DRV1	12	O	Compensation coil driver output 1
DRV2	11	O	Compensation coil driver output 2
ERROR	19	O	Error flag: open-drain, active-low output
GND	7, 10, 18, 20	—	Ground reference
OR	15	O	Shunt-sense amplifier overrange indicator: open-drain, active-low output
PowerPAD		—	Connect the thermal pad to GND
REFIN	5	I	Common-mode reference input for the shunt-sense amplifier
REFOUT	4	O	Voltage reference output
RSEL0	3	I	Voltage reference mode selection input 0
RSEL1	2	I	Voltage reference mode selection input 1
VDD	8, 9	—	Supply voltage, 3.0 V to 5.5 V. Decouple both pins using 1- $\mu$ F ceramic capacitors placed as close as possible to the device. See the <a href="#">Power-Supply Decoupling</a> and <a href="#">Layout</a> sections for further details.
VOUT	6	O	Shunt-sense amplifier output

## 6 Specifications

### 6.1 Absolute Maximum Ratings

 over operating free-air temperature range (unless otherwise noted)<sup>(1)</sup>

		MIN	MAX	UNIT
Voltage	Supply voltage (VDD to GND)	-0.3	6.5	V
	Input voltage, except AINP and AINN pins <sup>(2)</sup>	GND – 0.5	VDD + 0.5	
	Shunt-sense amplifier inputs (AINP and AINN pins) <sup>(3)</sup>	GND – 6.0	VDD + 6.0	
Current	DRV1 and DRV2 pins (short-circuit current, I <sub>OS</sub> ) <sup>(4)</sup>	-300	300	mA
	Shunt-sense amplifier input pins AINP and AINN	-5	5	
	All remaining pins	-25	25	
Temperature	Junction, T <sub>J</sub> max	-50	150	°C
	Storage, T <sub>stg</sub>	-65	150	

- (1) Stresses beyond those listed under *Absolute Maximum Ratings* may cause permanent damage to the device. These are stress ratings only, which do not imply functional operation of the device at these or any other conditions beyond those indicated under *Recommended Operating Conditions*. Exposure to absolute-maximum-rated conditions for extended periods may affect device reliability.
- (2) Input pins are diode-clamped to the power-supply rails. Input signals that can swing more than 0.5 V beyond the supply rails must be current limited, except for the differential amplifier input pins.
- (3) These inputs are not diode-clamped to the power-supply rails.
- (4) Power-limited; observe maximum junction temperature.

### 6.2 ESD Ratings

		VALUE	UNIT
V <sub>(ESD)</sub> Electrostatic discharge	Human-body model (HBM), per ANSI/ESDA/JEDEC JS-001 <sup>(1)</sup>	±2000	V
	Charged-device model (CDM), per JEDEC specification JESD22-C101 <sup>(2)</sup>	±1000	

- (1) JEDEC document JEP155 states that 500-V HBM allows safe manufacturing with a standard ESD control process.
- (2) JEDEC document JEP157 states that 250-V CDM allows safe manufacturing with a standard ESD control process.

### 6.3 Recommended Operating Conditions

over operating free-air temperature range (unless otherwise noted)

		MIN	NOM	MAX	UNIT
VDD	Supply voltage range (VDD to GND)	3.0	5.0	5.5	V
T <sub>A</sub>	Specified ambient temperature range	-40		125	°C

### 6.4 Thermal Information

THERMAL METRIC <sup>(1)</sup>		DRV425	UNIT
		RTJ (WQFN)	
		20 PINS	
R <sub>θJA</sub>	Junction-to-ambient thermal resistance	34.1	°C/W
R <sub>θJC(top)</sub>	Junction-to-case (top) thermal resistance	33.1	°C/W
R <sub>θJB</sub>	Junction-to-board thermal resistance	11	°C/W
ψ <sub>JT</sub>	Junction-to-top characterization parameter	0.3	°C/W
ψ <sub>JB</sub>	Junction-to-board characterization parameter	11	°C/W
R <sub>θJC(bot)</sub>	Junction-to-case (bottom) thermal resistance	2.1	°C/W

- (1) For more information about traditional and new thermal metrics, see the *IC Package Thermal Metrics* application report, [SPRA953](#).

## 6.5 Electrical Characteristics

All minimum and maximum specifications are at  $T_A = 25^\circ\text{C}$ ,  $V_{DD} = 3.0\text{ V to }5.5\text{ V}$ , and  $I_{\text{DRV1}} = I_{\text{DRV2}} = 0\text{ mA}$ , unless otherwise noted. Typical values are at  $V_{DD} = 5.0\text{ V}$ .

PARAMETER		TEST CONDITIONS	MIN	TYP	MAX	UNIT
<b>FLUXGATE SENSOR FRONT-END</b>						
	Offset	No magnetic field	-8	±2	8	μT
	Offset drift	No magnetic field		±5		nT/°C
G	Gain	Current at DRV1 and DRV2 outputs		12.2		mA/mT
	Gain error			±0.04%		
	Gain drift	Best-fit line method		±7		ppm/°C
	Linearity error			0.1%		
	Hysteresis	Magnetic field sweep from -10 mT to 10 mT		1.4		μT
	Noise	f = 0.1 Hz to 10 Hz		17		nTrms
	Noise density	f = 1 kHz		1.5		nT/√Hz
	Compensation range		-2		2	mT
	Saturation trip level for the ERROR pin <sup>(1)</sup>	Open-loop, uncompensated field		1.6		mT
	ERROR delay	Open-loop at B > 1.6 mT		4 to 6		μs
BW	Bandwidth	BSEL = 0, R <sub>SHUNT</sub> = 22 Ω		32		kHz
		BSEL = 1, R <sub>SHUNT</sub> = 22 Ω		47		
I <sub>OS</sub>	Short-circuit current	V <sub>DD</sub> = 5 V		250		mA
		V <sub>DD</sub> = 3.3 V		150		
	Common-mode output voltage at the DRV1 and DRV2 pins			V <sub>REFOUT</sub>		V
	Compensation coil resistance			100		Ω
<b>SHUNT-SENSE AMPLIFIER</b>						
V <sub>OO</sub>	Output offset voltage	V <sub>AINP</sub> = V <sub>AINN</sub> = V <sub>REFIN</sub> , V <sub>DD</sub> = 3.0 V	-0.075	±0.01	0.075	mV
	Output offset voltage drift		-2	±0.4	2	μV/°C
CMRR	Common-mode rejection ratio, RTO <sup>(2)</sup>	V <sub>CM</sub> = -1 V to V <sub>DD</sub> + 1 V, V <sub>REFIN</sub> = V <sub>DD</sub> / 2	-250	±50	250	μV/V
PSRR <sub>AMP</sub>	Power-supply rejection ratio, RTO <sup>(2)</sup>	V <sub>DD</sub> = 3.0 V to 5.5 V, V <sub>CM</sub> = V <sub>REFIN</sub>	-50	±4	50	μV/V
V <sub>ICR</sub>	Common-mode input voltage range		-1		V <sub>DD</sub> + 1	V
Z <sub>id</sub>	Differential input impedance		16.5	20	23.5	kΩ
Z <sub>ic</sub>	Common-mode input impedance		40	50	60	kΩ
G <sub>nom</sub>	Nominal gain	V <sub>VOU</sub> T / (V <sub>AINP</sub> - V <sub>AINN</sub> )		4		V/V
E <sub>G</sub>	Gain error		-0.3%	±0.02%	0.3%	
	Gain error drift		-5	±1	5	ppm/°C
	Linearity error			12		ppm
	Voltage output swing from negative rail (OR pin trip level) <sup>(1)</sup>	V <sub>DD</sub> = 5.5 V, I <sub>VOU</sub> T = 2.5 mA		48	85	mV
		V <sub>DD</sub> = 3.0 V, I <sub>VOU</sub> T = 2.5 mA		56	100	
	Voltage output swing from positive rail (OR pin trip level) <sup>(1)</sup>	V <sub>DD</sub> = 5.5 V, I <sub>VOU</sub> T = -2.5 mA	V <sub>DD</sub> - 85	V <sub>DD</sub> - 48		mV
		V <sub>DD</sub> = 3.0 V, I <sub>VOU</sub> T = -2.5 mA	V <sub>DD</sub> - 100	V <sub>DD</sub> - 56		
	Signal overrange indication delay (OR pin) <sup>(1)</sup>	V <sub>IN</sub> = 1-V step		2.5 to 3.5		μs
I <sub>OS</sub>	Short-circuit current	V <sub>OU</sub> T connected to GND		-18		mA
		V <sub>OU</sub> T connected to V <sub>DD</sub>		20		
BW <sub>-3dB</sub>	Bandwidth			2		MHz
SR	Slew rate			6.5		V/μs
t <sub>sa</sub>	Settling time	Large signal	ΔV = ± 2 V to 1%, no external filter	0.9		μs
		Small signal	ΔV = ± 0.4 V to 0.01%	8		
e <sub>n</sub>	Output voltage noise density	f = 1 kHz, compensation loop disabled		170		nV/√Hz
V <sub>REFIN</sub>	Input voltage range at pin REFIN	Input voltage range at REFIN pin	GND		V <sub>DD</sub>	V

(1) See the [Magnetic Field Range, Overage Indicator, and Error Flag](#) section for details on the behavior of the ERROR and OR outputs.

(2) Parameter value is referred-to-output (RTO).

## Electrical Characteristics (continued)

All minimum and maximum specifications are at  $T_A = 25^\circ\text{C}$ ,  $V_{DD} = 3.0\text{ V to }5.5\text{ V}$ , and  $I_{DRV1} = I_{DRV2} = 0\text{ mA}$ , unless otherwise noted. Typical values are at  $V_{DD} = 5.0\text{ V}$ .

PARAMETER		TEST CONDITIONS	MIN	TYP	MAX	UNIT
<b>VOLTAGE REFERENCE</b>						
$V_{REFOUT}$	Reference output voltage at the REFOUT pin	RSEL[1:0] = 00, no load	2.45	2.5	2.55	V
		RSEL[1:0] = 01, no load	1.6	1.65	1.7	
		RSEL[1:0] = 1x, no load	45	50	55	% of VDD
	Reference output voltage drift	RSEL[1:0] = 0x	-50	±10	50	ppm/°C
	Voltage divider gain error drift	RSEL[1:0] = 1x	-50	±10	50	ppm/°C
$PSRR_{REF}$	Power-supply rejection ratio	RSEL[1:0] = 0x	-300	±15	300	μV/V
$\Delta V_{O(\Delta I_O)}$	Load regulation	RSEL[1:0] = 0x, load to GND or VDD, $\Delta I_{LOAD} = 0\text{ mA to }5\text{ mA}$ , $T_A = -40^\circ\text{C to }+125^\circ\text{C}$		0.15	0.35	mV/mA
		RSEL[1:0] = 1x, load to GND or VDD, $\Delta I_{LOAD} = 0\text{ mA to }5\text{ mA}$ , $T_A = -40^\circ\text{C to }+125^\circ\text{C}$		0.3	0.8	
$I_{OS}$	Short-circuit current	REFOUT connected to VDD		20		mA
		REFOUT connected to GND		-18		mA
<b>DIGITAL INPUTS/OUTPUTS (CMOS)</b>						
$I_{IL}$	Input leakage current			0.01		μA
$V_{IH}$	High-level input voltage	$T_A = -40^\circ\text{C to }+125^\circ\text{C}$	$0.7 \times V_{DD}$		$V_{DD} + 0.3$	V
$V_{IL}$	Low-level input voltage	$T_A = -40^\circ\text{C to }+125^\circ\text{C}$	-0.3		$0.3 \times V_{DD}$	V
$V_{OH}$	High-level output voltage	Open-drain output	Set by external pullup resistor			V
$V_{OL}$	Low-level output voltage	4-mA sink current		0.3		V
<b>POWER SUPPLY</b>						
$I_Q$	Quiescent current	$I_{DRV1/2} = 0\text{ mA}$ , $3.0\text{ V} \leq V_{DD} \leq 3.6\text{ V}$ , $T_A = -40^\circ\text{C to }+125^\circ\text{C}$		6	8	mA
		$I_{DRV1/2} = 0\text{ mA}$ , $4.5\text{ V} \leq V_{DD} \leq 5.5\text{ V}$ , $T_A = -40^\circ\text{C to }+125^\circ\text{C}$		7	10	
$V_{POR}$	Power-on reset threshold			2.4		V

## 6.6 Typical Characteristics

at VDD = 5 V and T<sub>A</sub> = 25°C (unless otherwise noted)

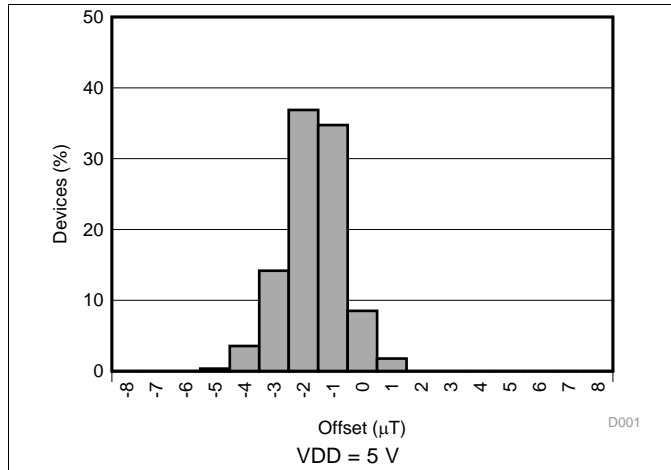

Figure 1. Fluxgate Sensor Front-End Offset Histogram

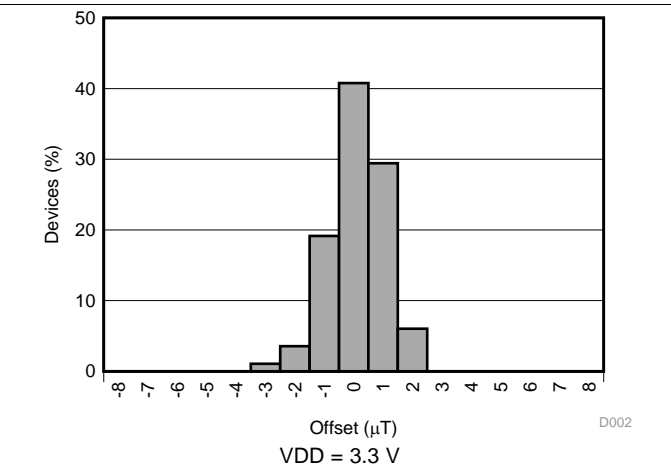

Figure 2. Fluxgate Sensor Front-End Offset Histogram

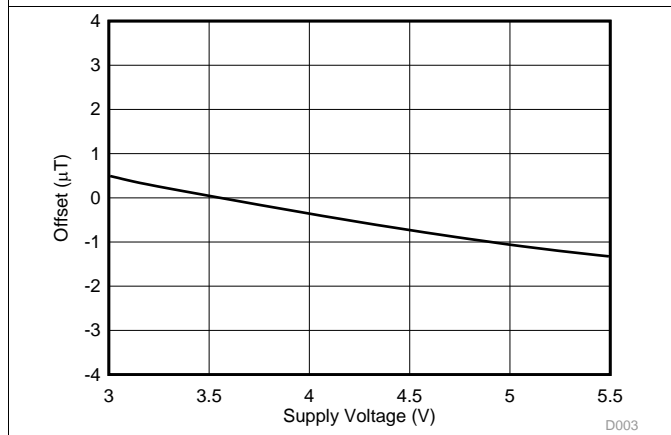

Figure 3. Fluxgate Sensor Front-End Offset vs Supply Voltage

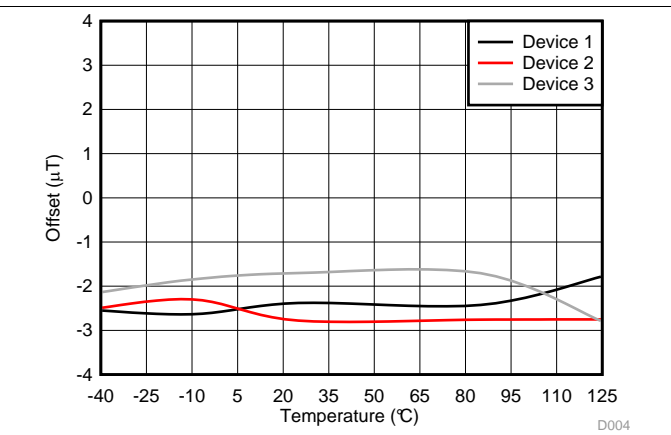

Figure 4. Fluxgate Sensor Front-End Offset vs Temperature

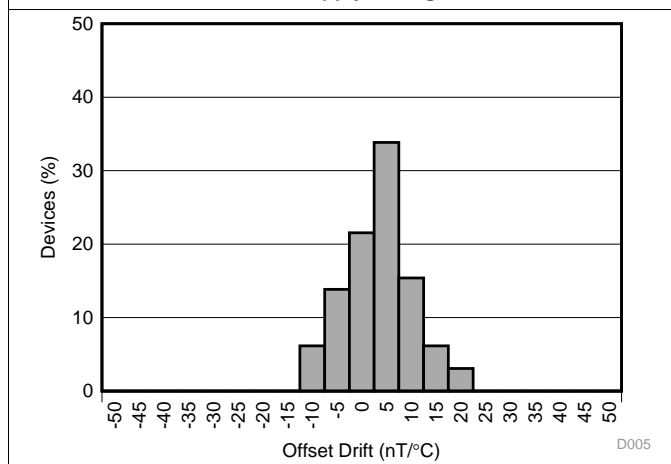

Figure 5. Fluxgate Sensor Front-End Offset Drift Histogram

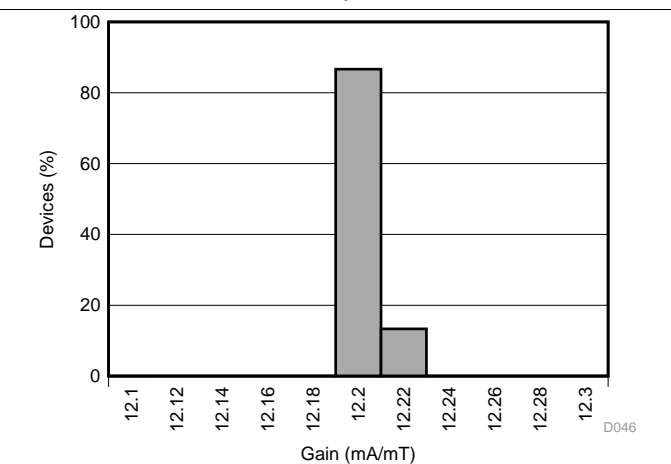
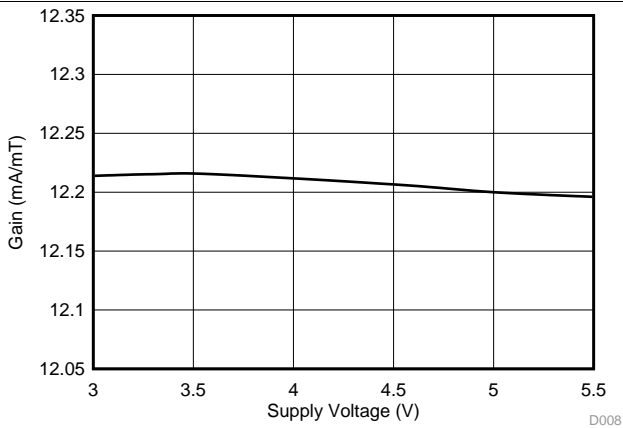

Figure 6. Fluxgate Sensor Front-End Gain Histogram

**Typical Characteristics (continued)**

at VDD = 5 V and T<sub>A</sub> = 25°C (unless otherwise noted)



**Figure 7. Fluxgate Sensor Front-End Gain vs Supply Voltage**

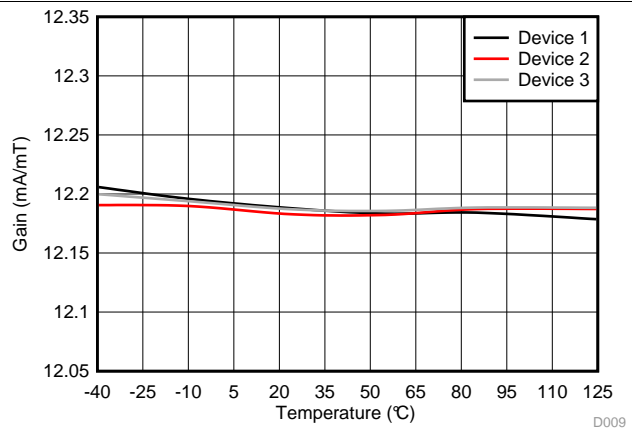

**Figure 8. Fluxgate Sensor Front-End Gain vs Temperature**

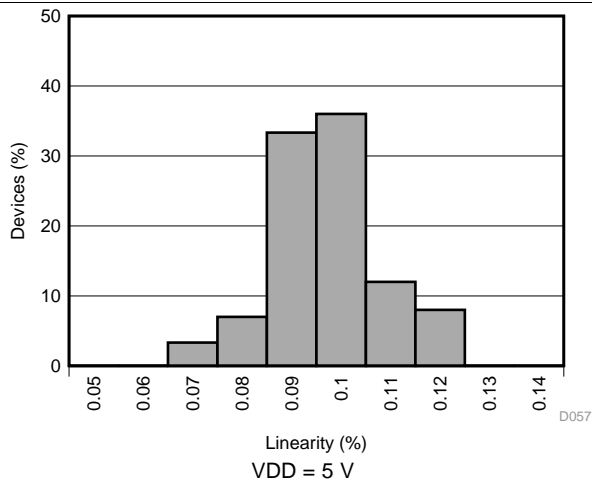

**Figure 9. Fluxgate Sensor Front-End Linearity Histogram**

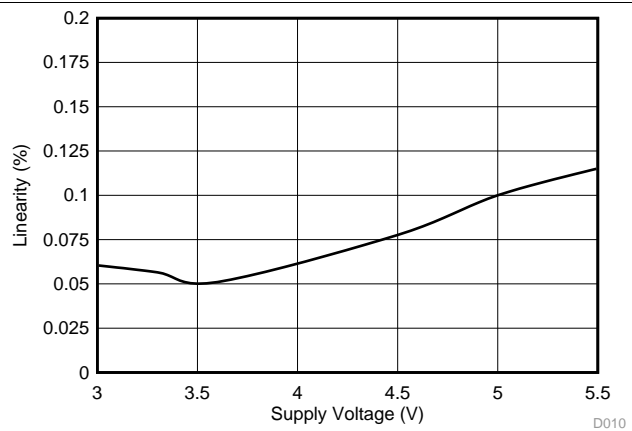

**Figure 10. Fluxgate Sensor Front-End Linearity vs Supply Voltage**

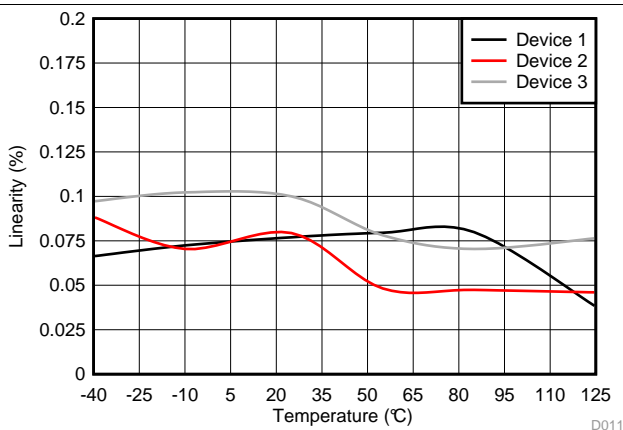

**Figure 11. Fluxgate Sensor Front-End Linearity vs Temperature**

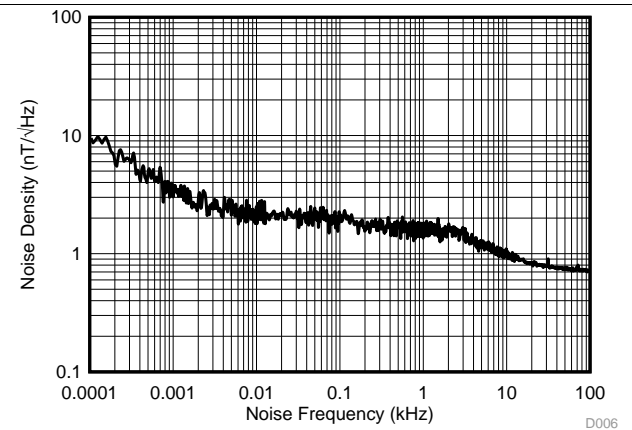

**Figure 12. Fluxgate Sensor Front-End Noise Density vs Noise Frequency**



Typical Characteristics (continued)

at VDD = 5 V and TA = 25°C (unless otherwise noted)

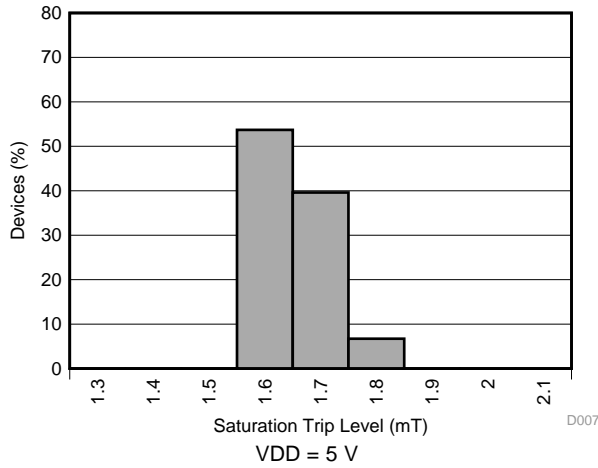

Figure 13. Fluxgate Sensor Saturation (ERROR Pin) Trip Level Histogram

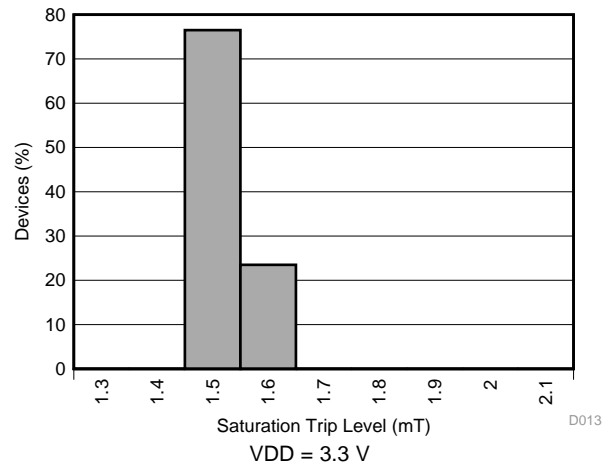

Figure 14. Fluxgate Sensor Saturation (ERROR Pin) Trip Level Histogram

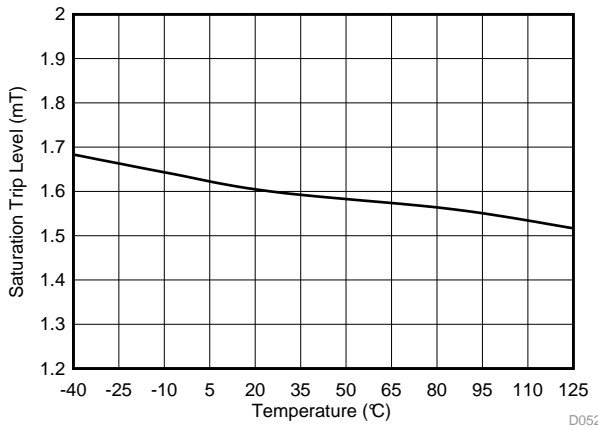

Figure 15. Fluxgate Sensor Saturation (ERROR Pin) Trip Level vs Temperature

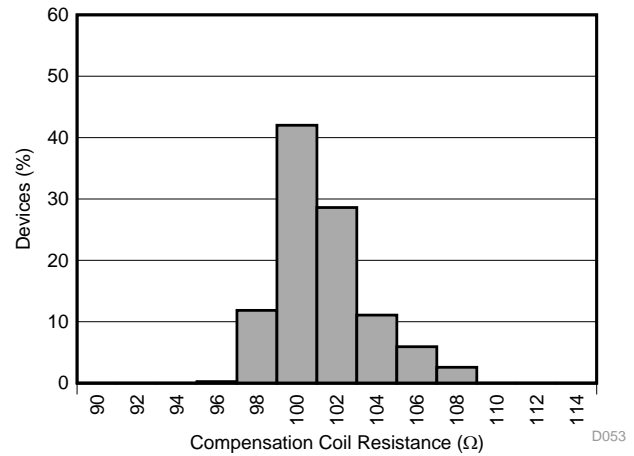

Figure 16. Compensation Coil Resistance Histogram

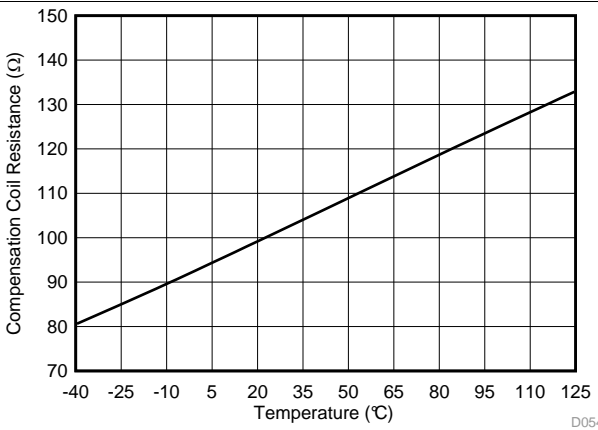

Figure 17. Compensation Coil Resistance vs Temperature

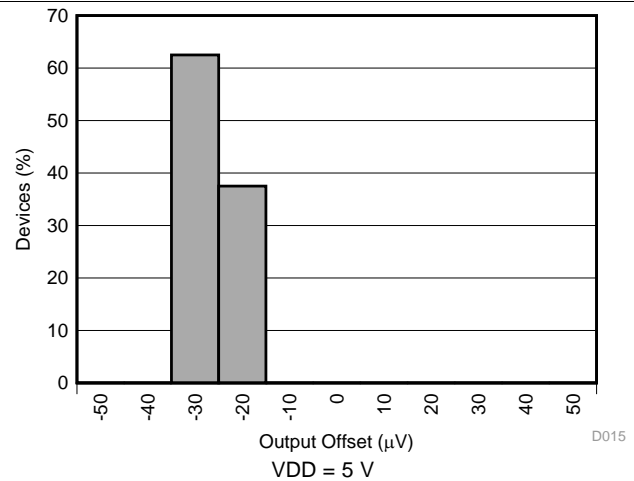

Figure 18. Shunt-Sense Amplifier Output Offset Histogram

### Typical Characteristics (continued)

at VDD = 5 V and T<sub>A</sub> = 25°C (unless otherwise noted)

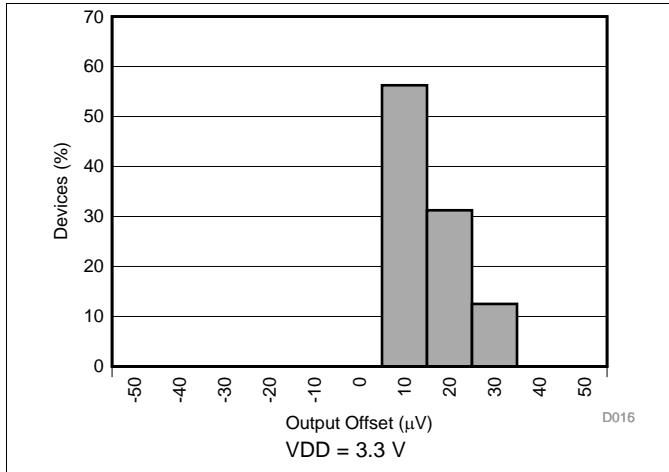

Figure 19. Shunt-Sense Amplifier Output Offset Histogram

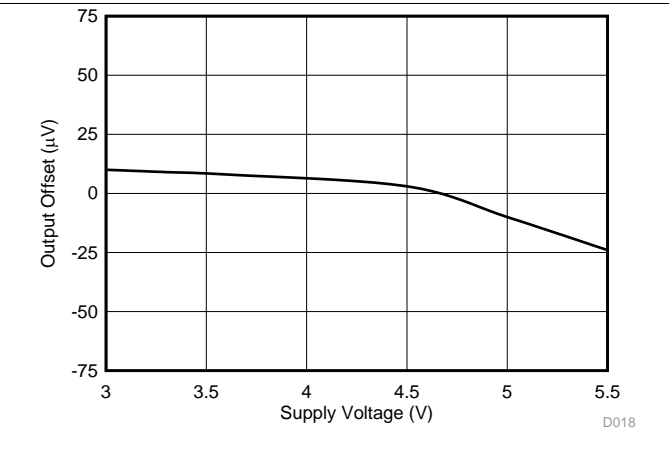

Figure 20. Shunt-Sense Amplifier Output Offset vs Supply Voltage

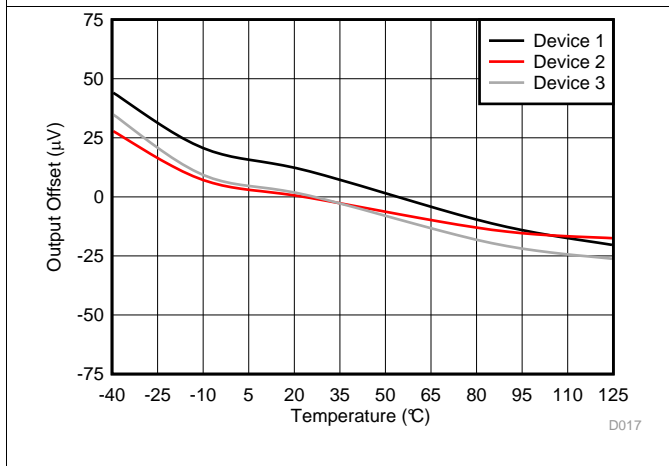

Figure 21. Shunt-Sense Amplifier Output Offset vs Temperature

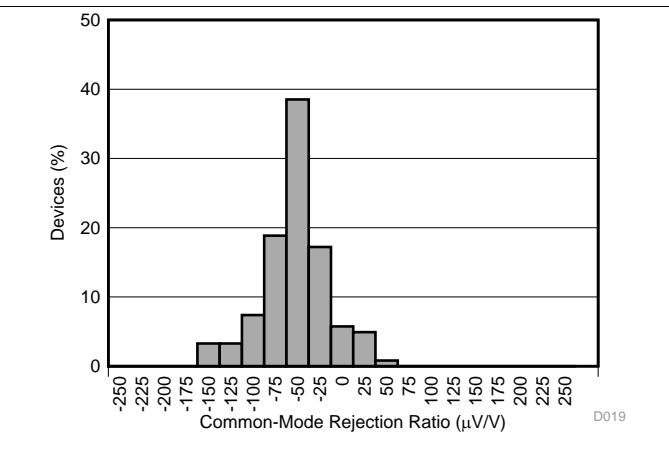

Figure 22. Shunt-Sense Amplifier CMRR Histogram

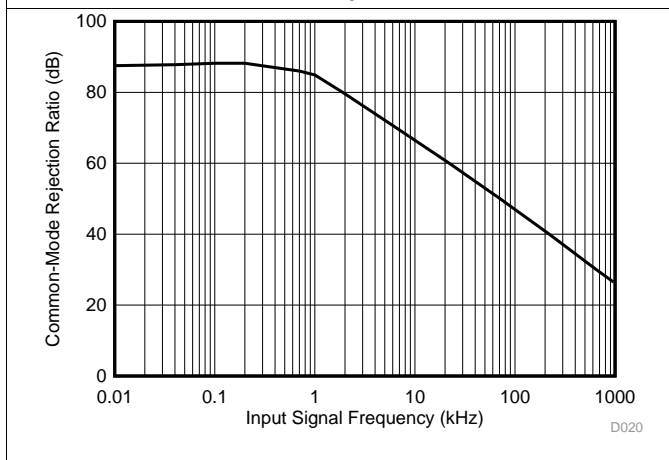

Figure 23. Shunt-Sense Amplifier CMRR vs Input Signal Frequency

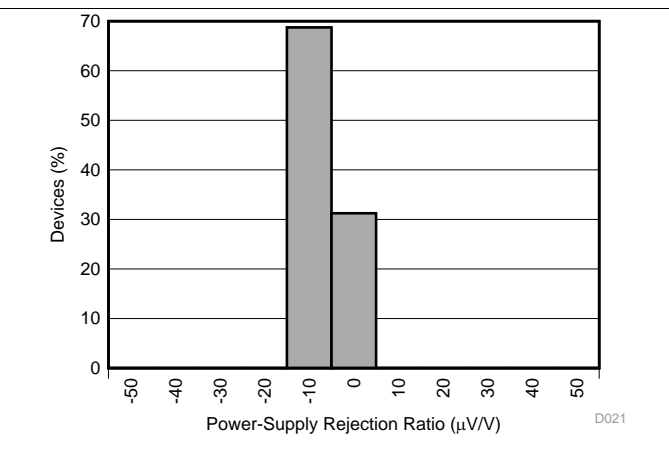
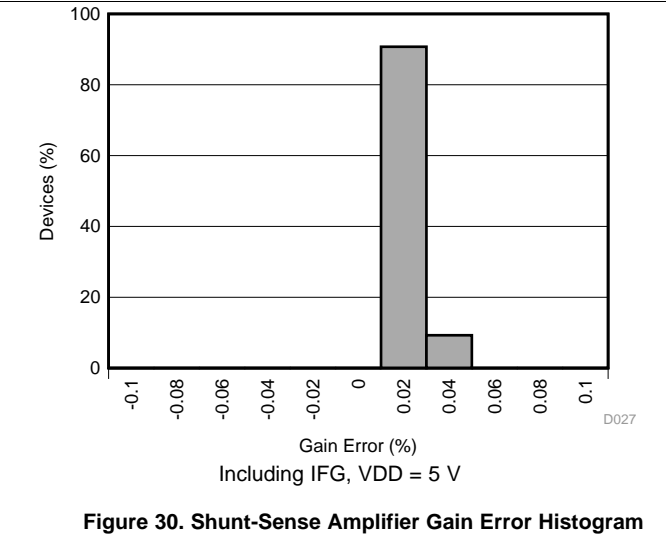
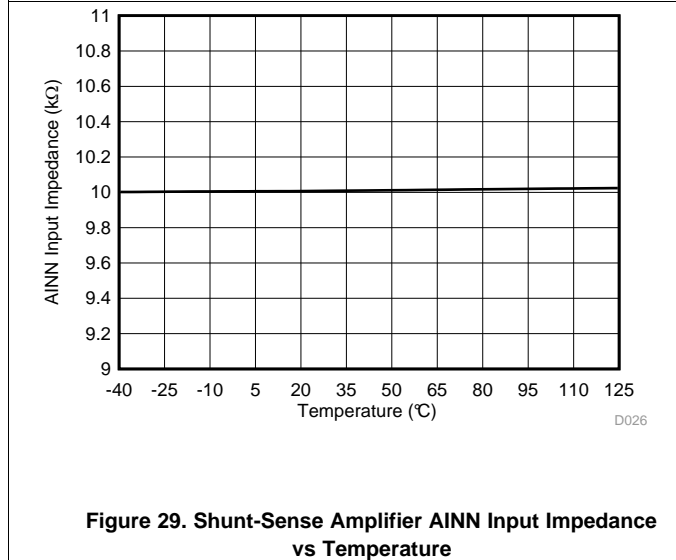
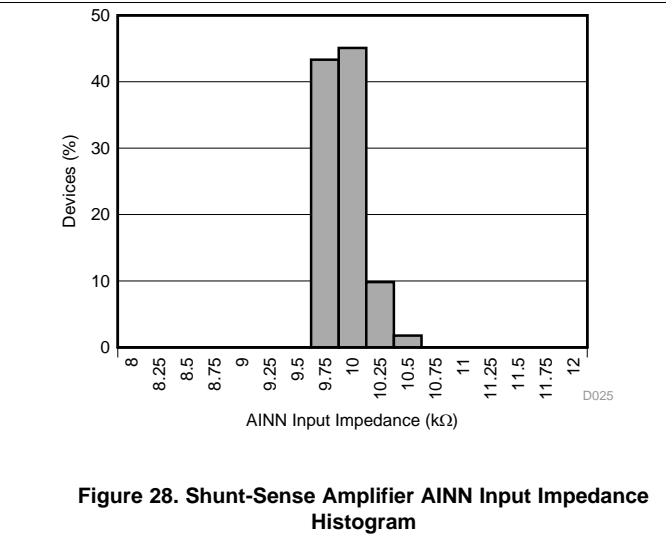
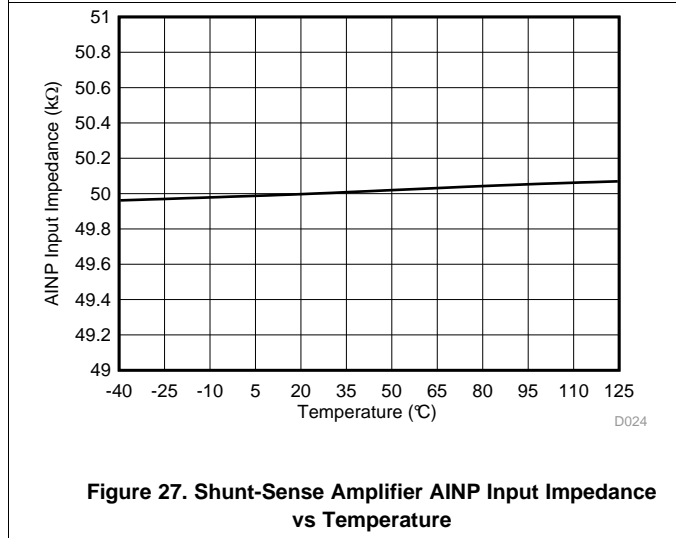
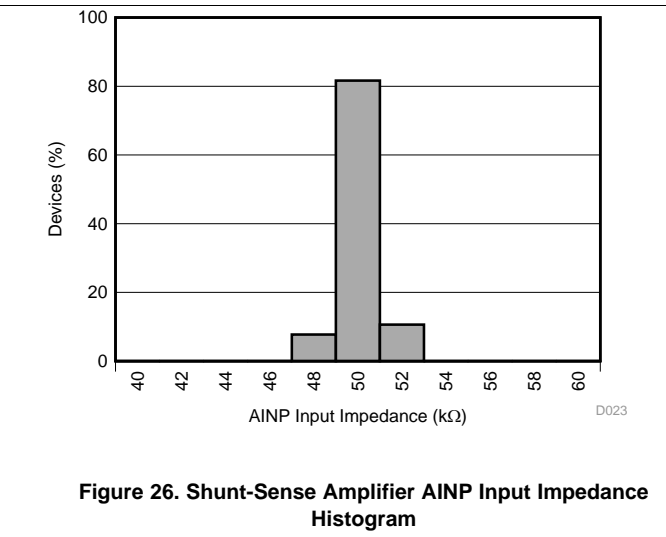
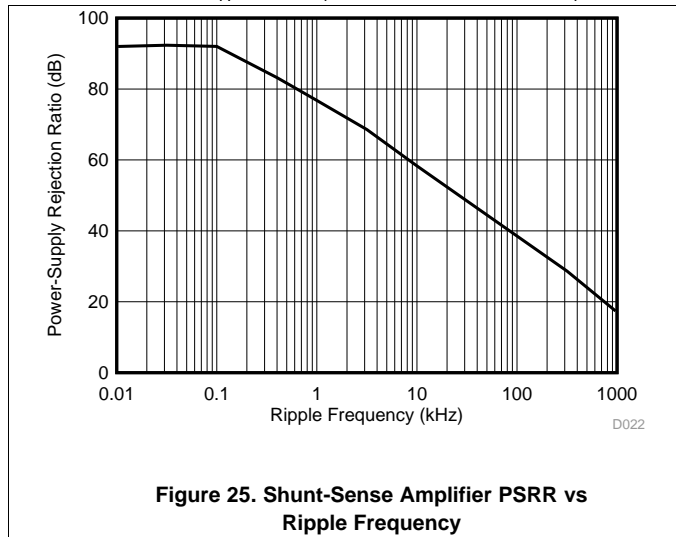

Figure 24. Shunt-Sense Amplifier PSRR Histogram

**Typical Characteristics (continued)**

at VDD = 5 V and TA = 25°C (unless otherwise noted)



Typical Characteristics (continued)

at VDD = 5 V and TA = 25°C (unless otherwise noted)

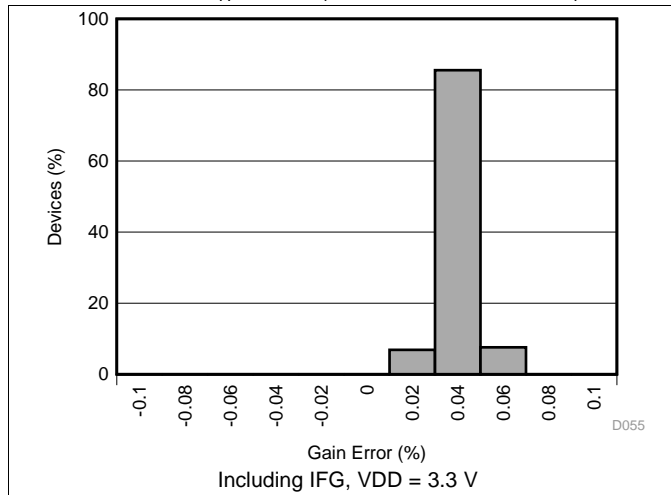

Figure 31. Shunt-Sense Amplifier Gain Error Histogram

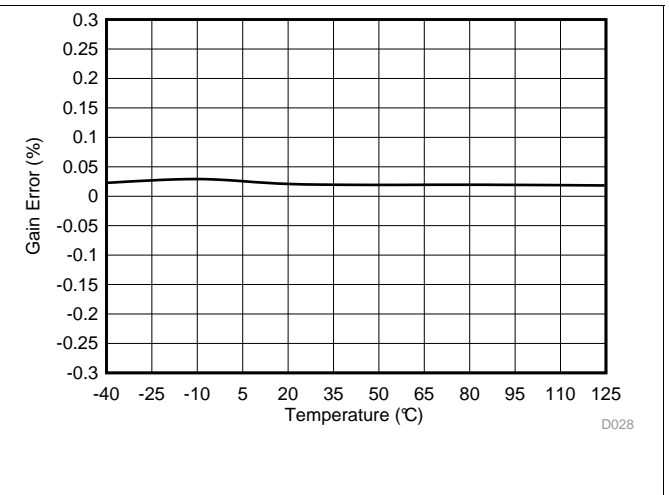

Figure 32. Shunt-Sense Amplifier Gain Error vs Temperature

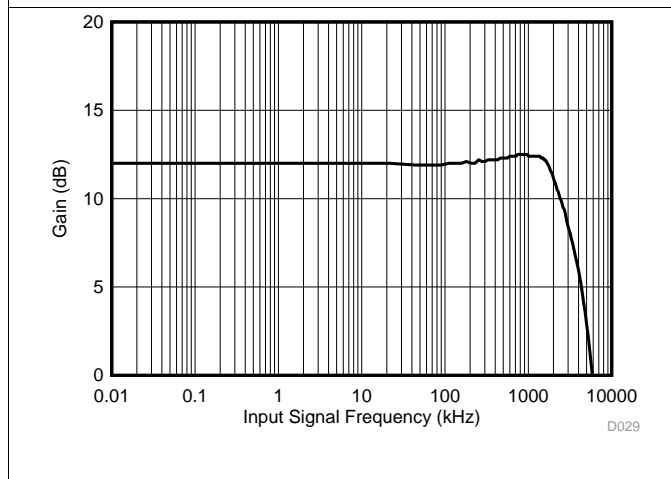

Figure 33. Shunt-Sense Amplifier Gain vs Input Signal Frequency

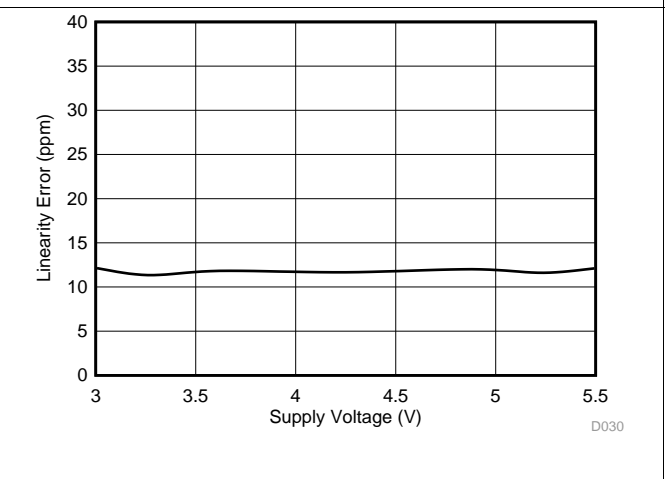

Figure 34. Shunt-Sense Amplifier Linearity Error vs Supply Voltage

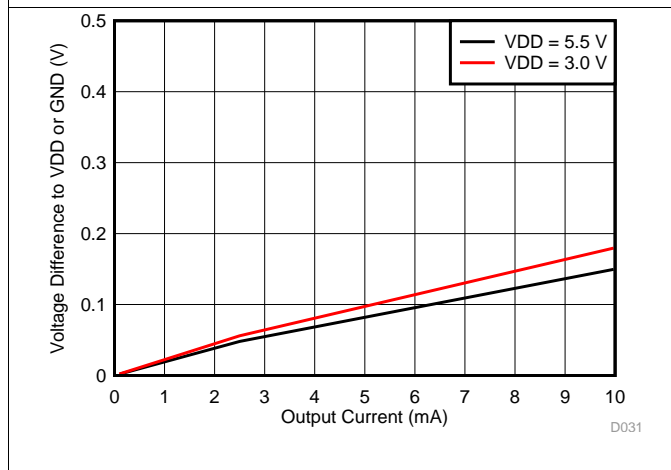

Figure 35. OR Pin Trip Level vs Output Current

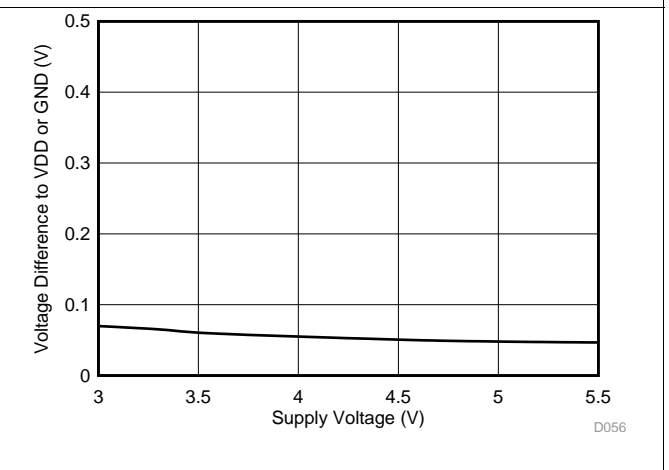

Figure 36. OR Pin Trip Level vs Supply Voltage

Typical Characteristics (continued)

at VDD = 5 V and TA = 25°C (unless otherwise noted)

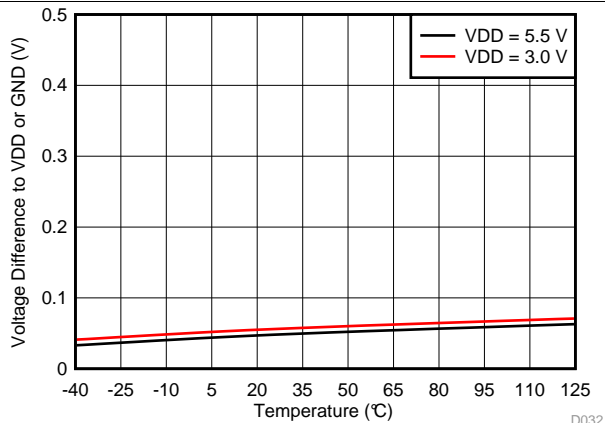

Figure 37. OR Pin Trip Level vs Temperature

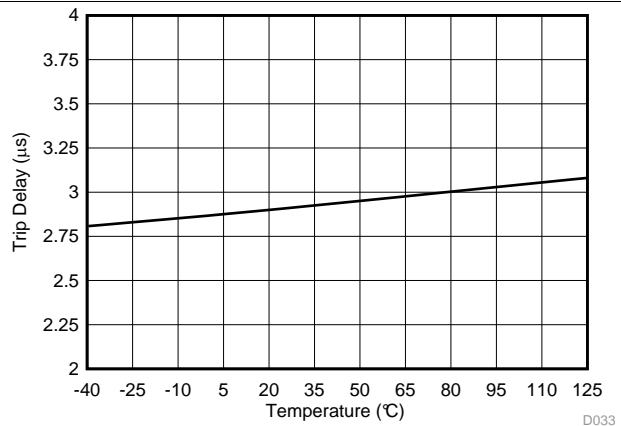

Figure 38. OR Pin Trip Delay vs Temperature

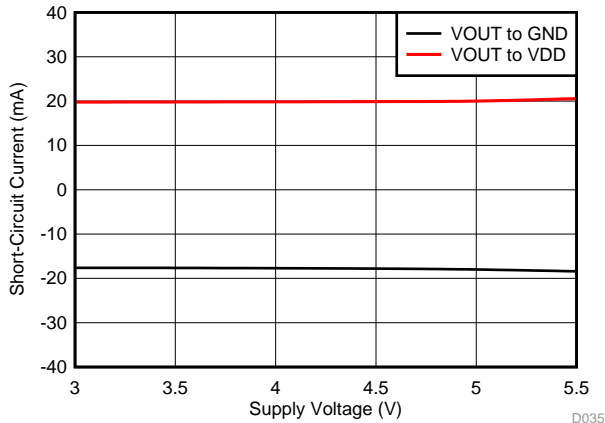

Figure 39. Shunt-Sense Amplifier Output Short-Circuit Current vs Supply Voltage

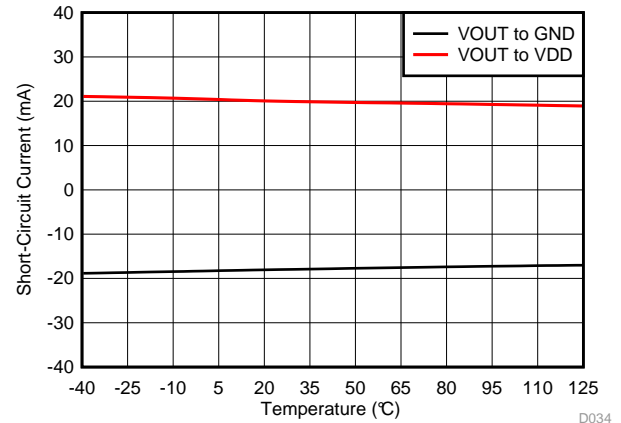

Figure 40. Shunt-Sense Amplifier Output Short-Circuit Current vs Temperature

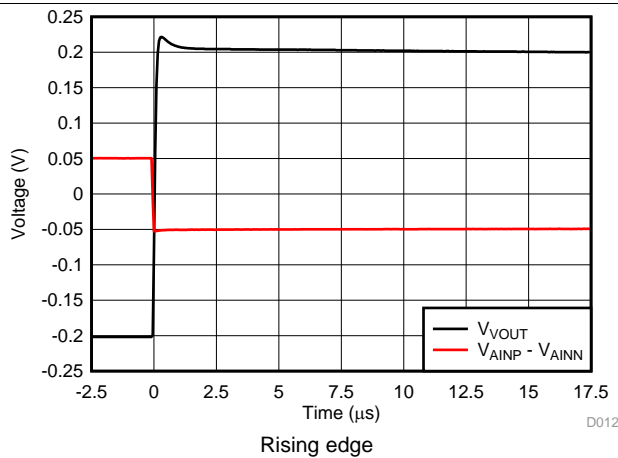

Figure 41. Shunt-Sense Amplifier Small-Signal Settling Time

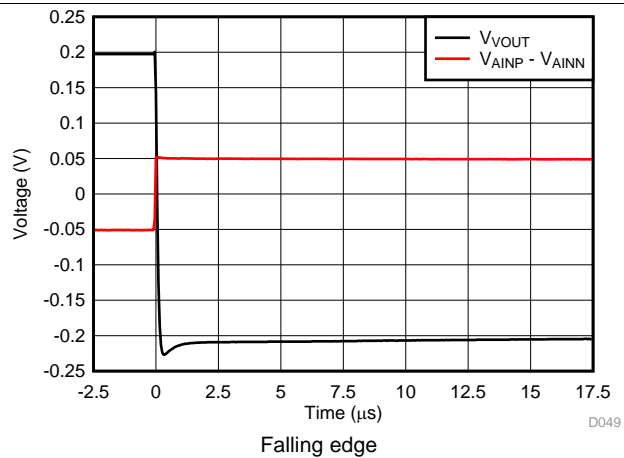
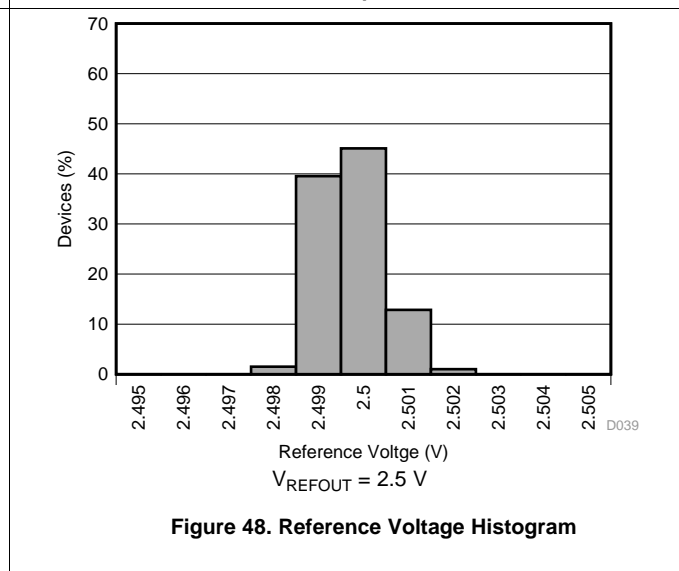
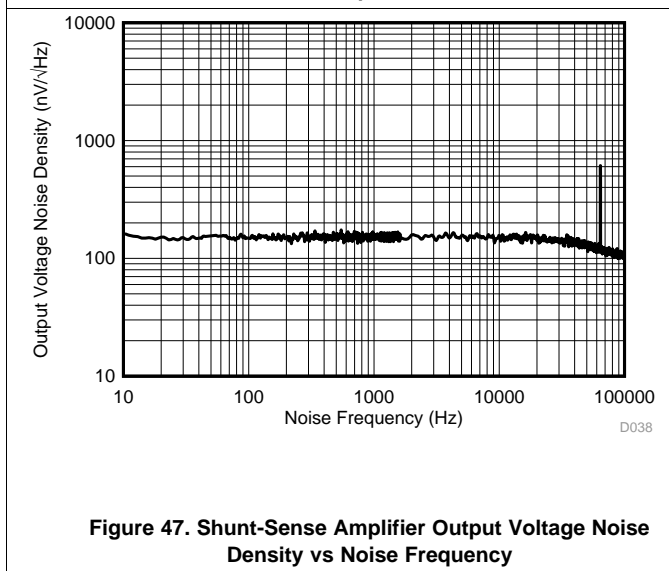
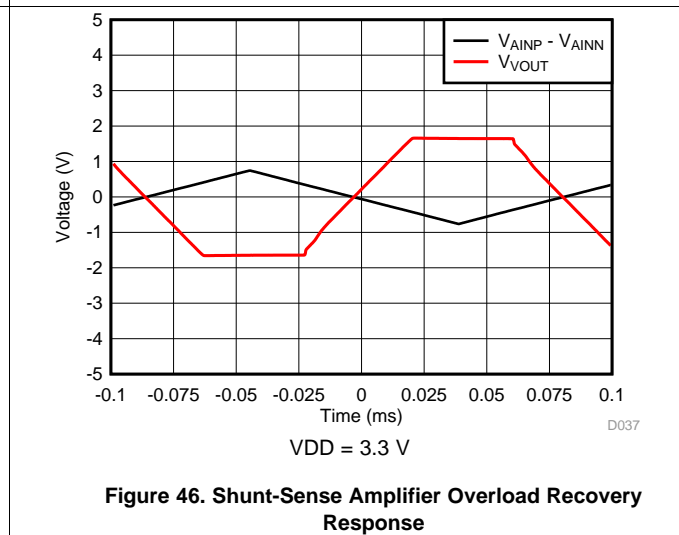
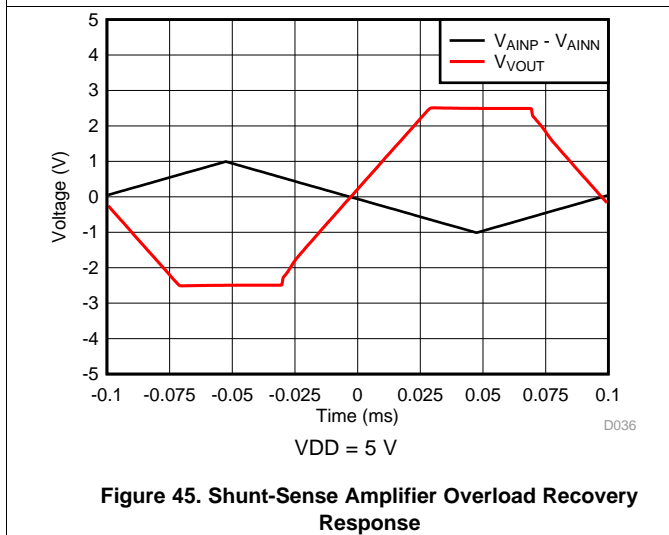
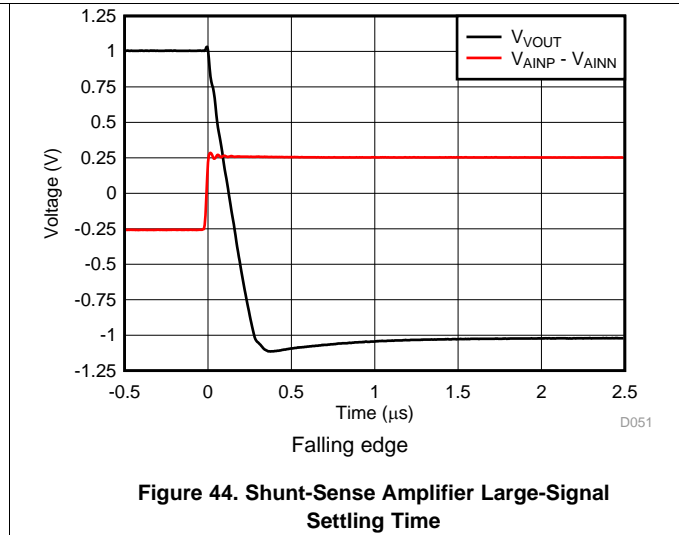
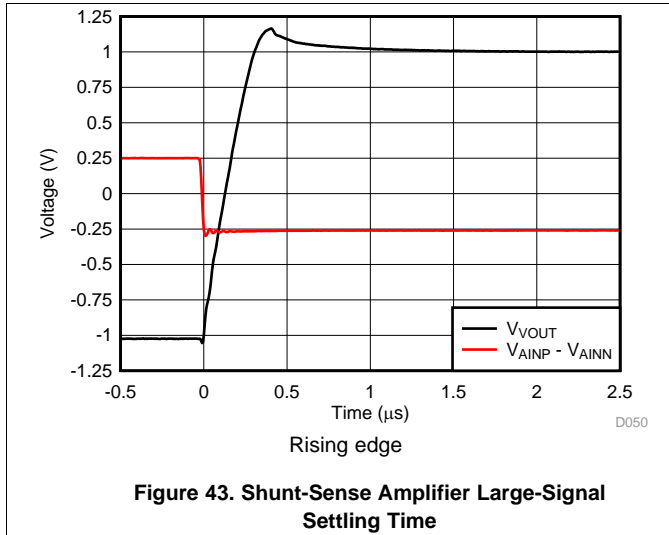

Figure 42. Shunt-Sense Amplifier Small-Signal Settling Time

### Typical Characteristics (continued)

at VDD = 5 V and T<sub>A</sub> = 25°C (unless otherwise noted)



Typical Characteristics (continued)

at VDD = 5 V and TA = 25°C (unless otherwise noted)

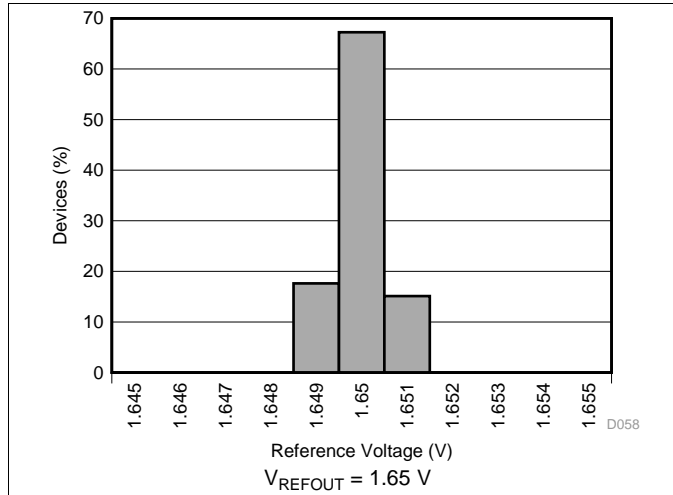

Figure 49. Reference Voltage Histogram

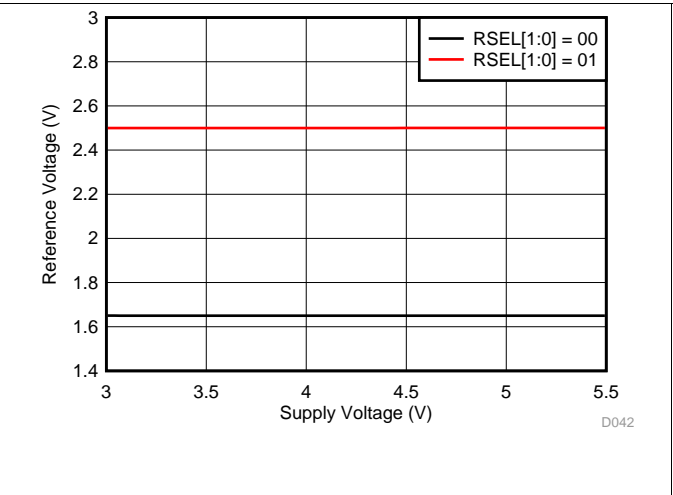

Figure 50. Reference Voltage vs Supply Voltage

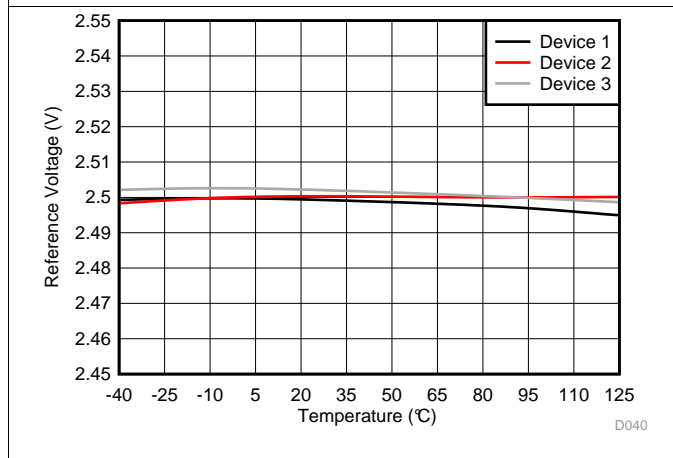

Figure 51. Reference Voltage vs Temperature

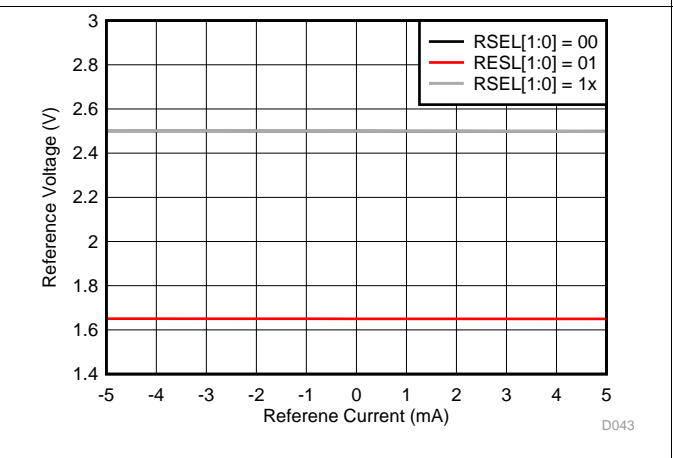

Figure 52. Reference Voltage vs Reference Output Current

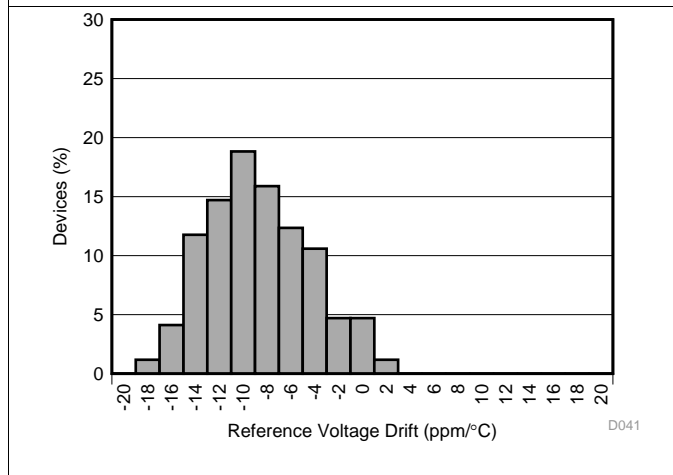

Figure 53. Reference Voltage Drift Histogram

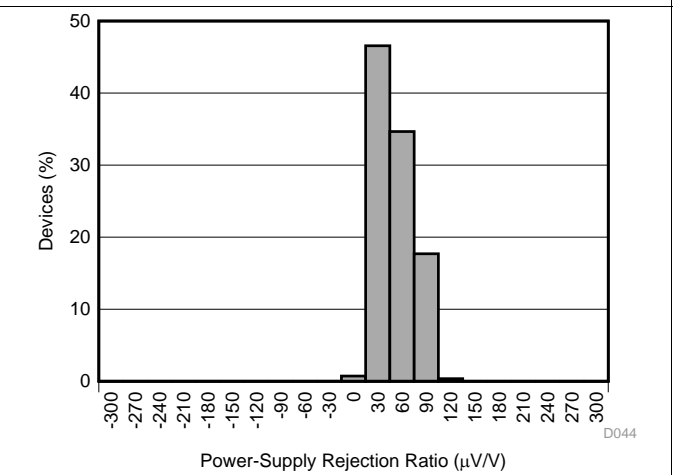

Figure 54. Reference Voltage PSRR Histogram

Typical Characteristics (continued)

at VDD = 5 V and T<sub>A</sub> = 25°C (unless otherwise noted)

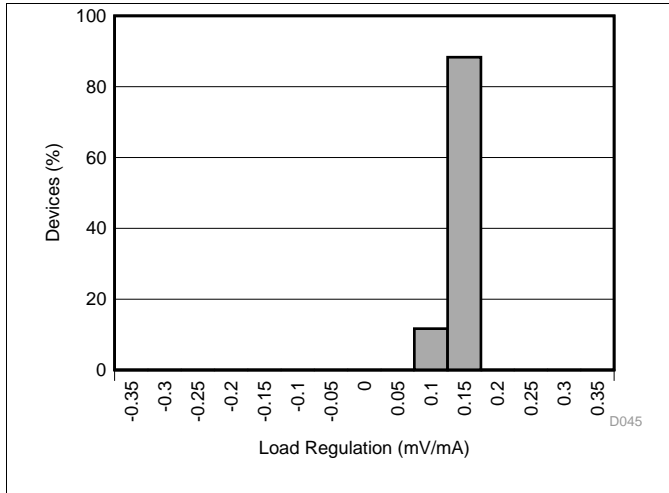

Figure 55. Reference Voltage Load Regulation Histogram

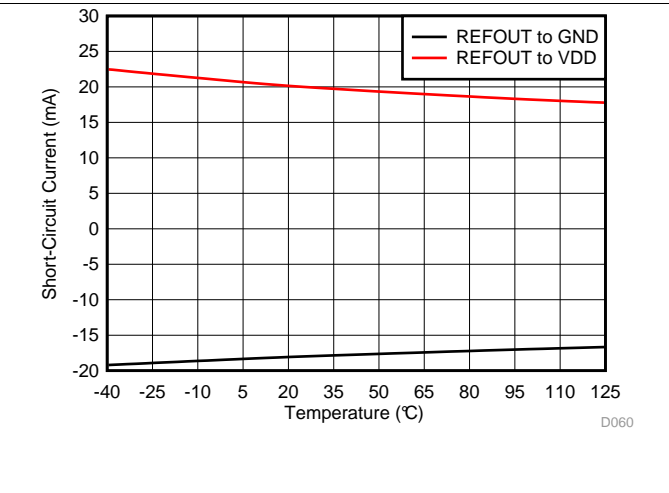

Figure 56. Reference Short-Circuit Current vs Temperature

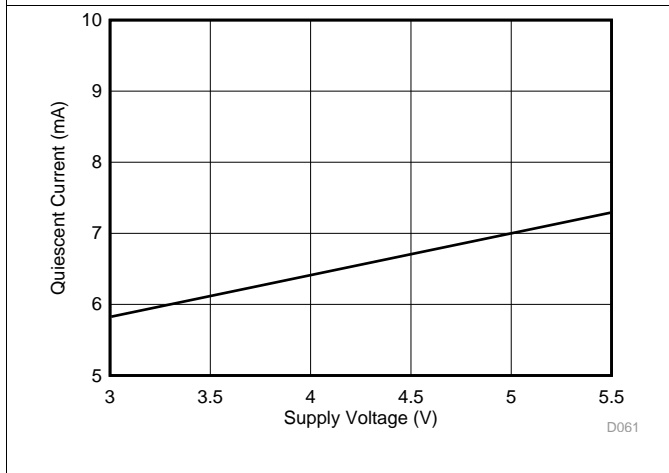

Figure 57. Quiescent Current vs Supply Voltage

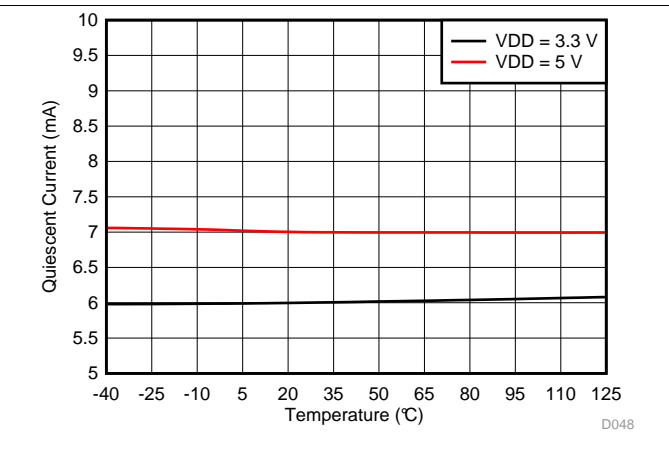

Figure 58. Quiescent Current vs Temperature

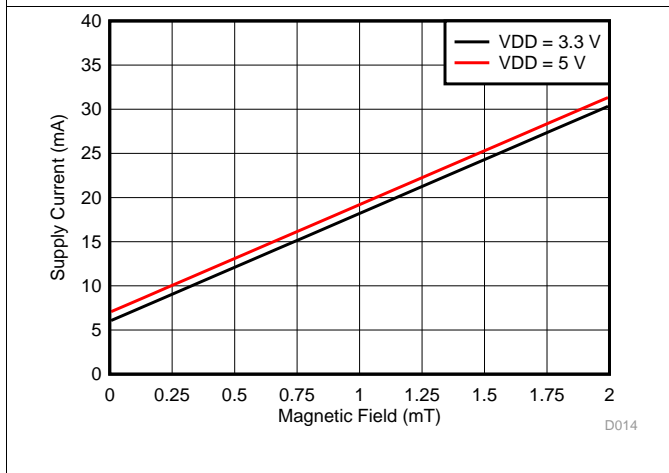

Figure 59. Supply Current vs Magnetic Field

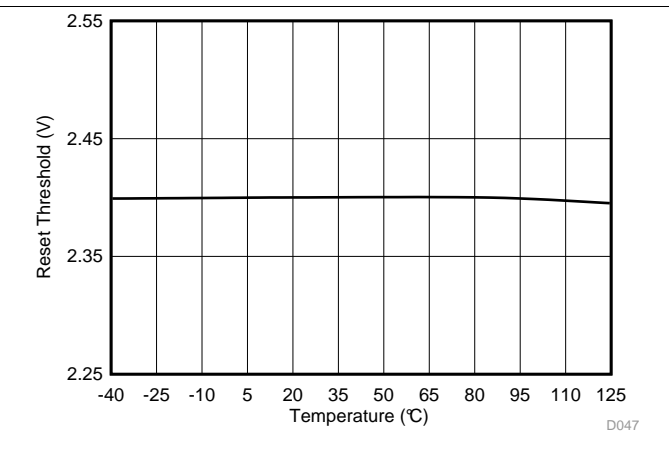

Figure 60. Power-On Reset Threshold vs Temperature



## 7 Detailed Description

### 7.1 Overview

Magnetic sensors are used in a broad range of applications (such as position, indirect ac and dc current, or torque measurement). Hall-effect sensors are most common in magnetic field sensing, but their offset, noise, gain variation, and nonlinearity limit the achievable resolution and accuracy of the system. Fluxgate sensors offer significantly higher sensitivity, lower drift, lower noise, and high linearity and enable up to 1000-times better accuracy of the measurement.

As shown in the [Functional Block Diagram](#) section, the DRV425 consists of a magnetic fluxgate sensor with the necessary sensor conditioning and compensation coil to internally close the control loop. The fluxgate sensor is repeatedly driven in and out of saturation and supports hysteresis-free operation with excellent accuracy. The internal compensation coil assures stable gain and high linearity.

The magnetic field (B) is detected by the internal fluxgate sensor in the DRV425. The device integrates the sensor output to assure high-loop gain. The integrator output connects to the built-in differential driver that drives an opposing compensation current through the internal compensation coil. The compensation coil generates an opposite magnetic field that brings the original magnetic field at the sensor back to zero.

The compensation current is proportional to the external magnetic field and its value is 12.2 mA/mT. This compensation current generates a voltage drop across an external shunt resistor,  $R_{SHUNT}$ . An integrated difference amplifier with a fixed gain of 4 V/V measures this voltage and generates an output voltage that is referenced to REF<sub>IN</sub> and is proportional to the magnetic field. The value of the output voltage at the V<sub>OUT</sub> pin ( $V_{VOUT}$ ) is calculated using [Equation 1](#):

$$V_{VOUT} [V] = B \times G \times R_{SHUNT} \times G_{AMP} = B [mT] \times 12.2 \text{ mA/mT} \times R_{SHUNT} [\Omega] \times 4 [V/V] \quad (1)$$

### 7.2 Functional Block Diagram

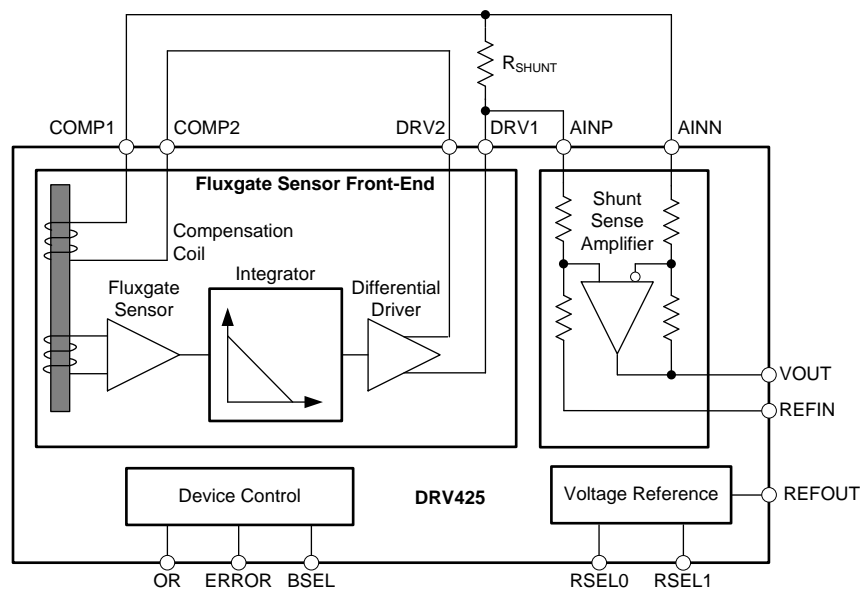

### 7.3 Feature Description

#### 7.3.1 Fluxgate Sensor Front-End

The following sections describe the functional blocks and features of the integrated fluxgate sensor front-end.

##### 7.3.1.1 Fluxgate Sensor

The fluxgate sensor of the DRV425 is uniquely suited for high-performance magnetic-field sensors because of the high sensitivity, low noise, and low offset of the sensor. The fluxgate principle relies on repeatedly driving the sensor in and out of saturation; therefore, the sensor is free of any significant magnetic hysteresis. The feedback loop accurately drives a compensation current through the integrated compensation coil and drives the magnetic field at the sensor back to zero. This approach supports excellent gain stability and high linearity of the measurement.

The DRV425 package is free of any ferromagnetic materials in order to prevent magnetization by external fields and to obtain accurate and hysteresis-free operation. Select non-magnetizable materials for the printed circuit board (PCB) and passive components in the direct vicinity of the DRV425; see the [Layout Guidelines](#) section for more details.

The orientation and the sensitivity axis of the fluxgate sensor is indicated by a dashed line on the top of the package, as shown in [Figure 61](#). [Figure 61](#) also shows the location of the sensor inside the package.

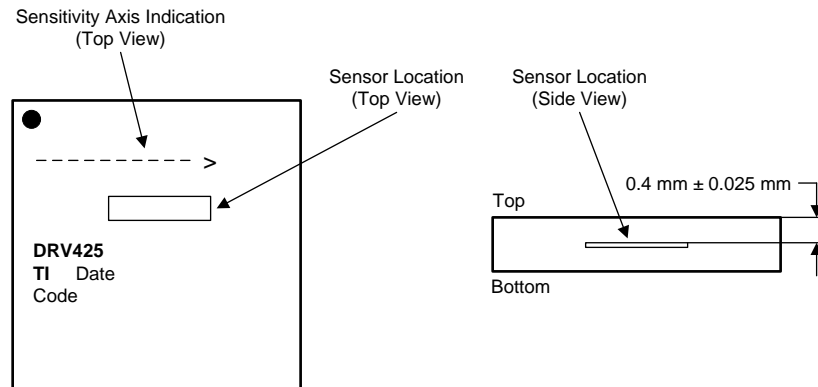

**Figure 61. Magnetic Sensitivity Direction of the Integrated Fluxgate Sensor**

The sensitivity of the fluxgate sensor is a vector function of its sensitivity axis and the magnetic field orientation. [Figure 62](#) shows the output of the DRV425 in dependency of the orientation of the device to a constant magnetic field.

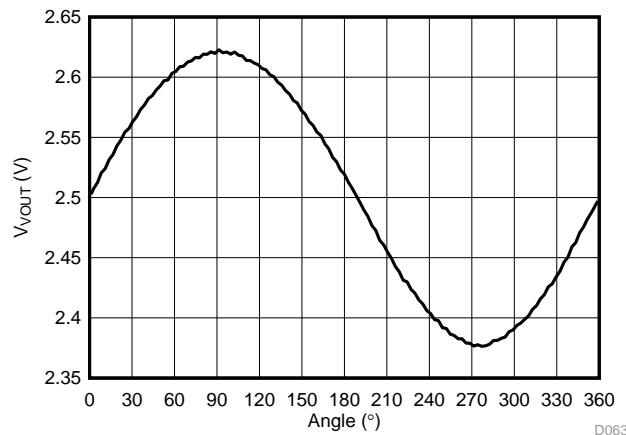

**Figure 62. DRV425 Output vs Magnetic Field Orientation**

## Feature Description (continued)

### 7.3.1.2 Bandwidth

The small-signal bandwidth of the DRV425 is determined by the behavior of the compensation loop versus frequency. The implemented integrator limits the bandwidth of the loop to provide stable response. Use the digital input pin BSEL to select the bandwidth. For a shunt resistor of 22 Ω and BSEL = 0, the bandwidth is 32 kHz; for BSEL = 1, the bandwidth is 47 kHz.

Bandwidth can be reduced by increasing the value of the shunt resistor because the shunt resistor and the compensation coil resistance form a voltage divider. The reduced bandwidth (BW) can be calculated using [Equation 2](#):

$$BW = \frac{R_{\text{COIL}} + 22 \Omega}{R_{\text{COIL}} + R_{\text{SHUNT}}} \times BW_{22 \Omega} = \frac{122 \Omega}{100 \Omega + R_{\text{SHUNT}}} \times BW_{22 \Omega}$$

where

- $R_{\text{COIL}}$  = internal compensation coil resistance (100 Ω),
- $R_{\text{SHUNT}}$  = external shunt resistance, and
- $BW_{22 \Omega}$  = sensor bandwidth with  $R_{\text{SHUNT}} = 22 \Omega$  (depending on the BSEL setting) (2)

The bandwidth for a given shunt resistor value can also be calculated using the *DRV425 System Parameter Calculator*, [SLOC331](#). For large magnetic fields ( $B > 500 \mu\text{T}$ ), the effective bandwidth of the sensor is limited by fluxgate saturation effects. For a magnetic signal with a 2-mT amplitude, the large-signal bandwidth is 10 kHz with BSEL = 0 or 15 kHz with BSEL = 1.

Although the analog output responds slowly to large fields, a magnetic field with a magnitude of 1.6 mT (or higher) beyond the measurement range of the DRV425 triggers the ERROR pin within 4 μs to 6 μs. See the [Magnetic Field Range, Overrange Indicator, and Error Flag](#) section for more details.

### 7.3.1.3 Differential Driver for the Internal Compensation Coil

The differential compensation coil driver provides the current for the internal compensation coil at the DRV1 and DRV2 pins. The driver is capable of sourcing up to ±250 mA with a 5-V supply or up to ±150 mA in 3.3-V mode. The current capability is not internally limited. The actual value of the compensation coil current depends on the magnetic field strength and is limited by the sum of the resistance of the internal compensation coil and the external shunt resistor value. The internal compensation coil resistance depends on temperature (see [Figure 17](#)) and must be taken into account when dimensioning the system. Select the value of the shunt resistor to avoid OR pin trip levels in normal operation.

The common-mode voltage of the compensation coil driver outputs is set by the RSEL pins (see the [Voltage Reference](#) section). Thus, the common-mode voltage of the shunt-sense amplifier is matched if the internal reference is used.

Consider the polarity of the compensation coil connection to the output of the compensation coil driver. If the polarity is incorrect, then the driver output drives to the power-supply rails, even at low primary-current levels. In this case, interchange the connection of the DRV1 and DRV2 pins to the compensation coil.

## Feature Description (continued)

### 7.3.1.4 Magnetic Field Range, Overrange Indicator, and Error Flag

The measurement range of the DRV425 is determined by the amount of current driven into the compensation coil and the output voltage range of the shunt-sense amplifier. The maximum compensation current is limited by the supply voltage and the series resistance of the compensation coil and the shunt.

The magnetic field range is adjusted with the external shunt resistor. The *DRV425 System Parameter Calculator*, [SLOC331](#) provides the maximum shunt resistor values depending on the supply voltage (VDD) and the selected reference voltage (V<sub>REFIN</sub>) for various magnetic field ranges.

For proper operation at a maximum field (B<sub>MAX</sub>), choose a shunt resistor (R<sub>SHUNT</sub>) using [Equation 3](#)

$$R_{SHUNT} \leq \frac{\min((VDD - V_{REFIN}), V_{REFIN}) - 0.085 \text{ V}}{B_{MAX} \times 12.2 \text{ A/T} \times 4 \text{ V/V}}$$

where

- VDD = minimum supply voltage of the DRV425 (V),
- V<sub>REFIN</sub> = common-mode voltage of the shunt-sense amplifier (V), and
- B<sub>MAX</sub> = desired magnetic field range (T) (3)

Alternatively, to adjust the output voltage of the DRV425 for a desired maximum voltage (V<sub>VOU<sub>T</sub>MAX</sub>), use [Equation 4](#):

$$R_{SHUNT} \leq \frac{V_{VOU_{TMAX}} - V_{REFIN}}{B_{MAX} \times 12.2 \text{ A/T} \times 4 \text{ V/V}}$$

where

- V<sub>VOU<sub>T</sub>MAX</sub> = desired maximum output voltage at VOUT pin (V), and
- B<sub>MAX</sub> = desired magnetic field range (T) (4)

To avoid railing of the compensation coil driver, assure that [Equation 5](#) is fulfilled:

$$\frac{B_{MAX} \times (R_{COIL} + R_{SHUNT}) \times 12.2 \text{ A/T}}{2} + 0.1 \text{ V} \leq \min((VDD - V_{REFIN}), V_{REFIN})$$

where

- B<sub>MAX</sub> = desired magnetic field range (T),
- R<sub>COIL</sub> = compensation coil resistance (Ω),
- VDD = minimum supply voltage of the DRV425 (V), and
- V<sub>REFIN</sub> = selected internal reference voltage value (V) (5)

The *DRV425 System Parameter Calculator*, [SLOC331](#) is designed to assist with selecting the system parameters.

The DRV425 offers two diagnostic output pins to detect large fields that exceed the measurement range of the sensor: the overrange indicator (OR) and the ERROR flag.

In normal operation, the DRV425 sensor feedback loop compensates the magnetic field inside the fluxgate to zero. Therefore, a large field inside the fluxgate indicates that the feedback loop is not properly working and the sensor output is invalid. To detect this condition, the ERROR pin is pulled low if the internal field exceeds 1.6 mT. The ERROR output is suppressed for 4 μs to 6 μs to prevent an undesired reaction to transients or noise. For static and slowly varying ambient fields, the ERROR pin triggers when the ambient field exceeds the sensor measurement range by more than 1.6 mT. For dynamic magnetic fields that exceed the sensor bandwidth as specified in the [Specifications](#) section, the feedback loop response is too slow to accurately compensate the internal field to zero. Therefore, high-frequency fields can trigger the ERROR pin, even if the ambient field does not exceed the measurement range by 1.6 mT.

In addition, the low-active overrange pin (OR) indicates railing of the output of the shunt-sense amplifier. The OR output is suppressed for 2.5 μs to 3.5 μs to prevent an undesired reaction to transients or noise. The OR pin trip level refers to the output voltage value of the shunt-sense amplifier as specified in the [Specifications](#) section. Use [Equation 3](#) and [Equation 4](#) to adjust the OR pin behavior to the specific system-level requirements.

### Feature Description (continued)

Both the ERROR and OR pins are open-drain outputs that require an external pullup resistor. Connect both pins together with a single pullup resistor to provide a single diagnostic flag, if desired.

Based on the *DRV425 System Parameter Calculator*, [SLOC331](#), for a design for a  $\pm 2$ -mT magnetic field input range with a supply of 5 V ( $\pm 5\%$ ), a shunt resistor value of 22  $\Omega$  is selected and [Figure 63](#) shows the status of the diagnostic flags in the resulting three operation ranges.

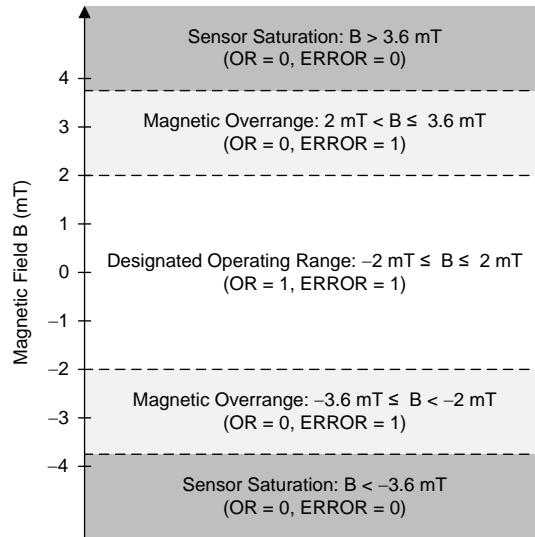

**Figure 63. Magnetic Field Range of the DRV425 (VDD = 5 V and R<sub>SHUNT</sub> = 22  $\Omega$ )**

With the proper R<sub>SHUNT</sub> value, the differential amplifier output rails and activates the overrange flag (OR = 0) when the magnetic field exceeds the designated operating range. For fields that exceed the measurement range of the DRV425 by  $\geq 1.6$  mT, the fluxgate is permanently saturated and the ERROR pin is pulled low. In this condition, the fluxgate sensor does not provide a valid output value and, therefore, the output VOUT of the DRV425 must be ignored. In applications where the ERROR pin cannot be separately monitored, combining the VOUT and ERROR outputs is recommended (as shown in [Figure 64](#)) to indicate a magnetic field outside of the sensor range by pulling the output of the DRV425 to ground.

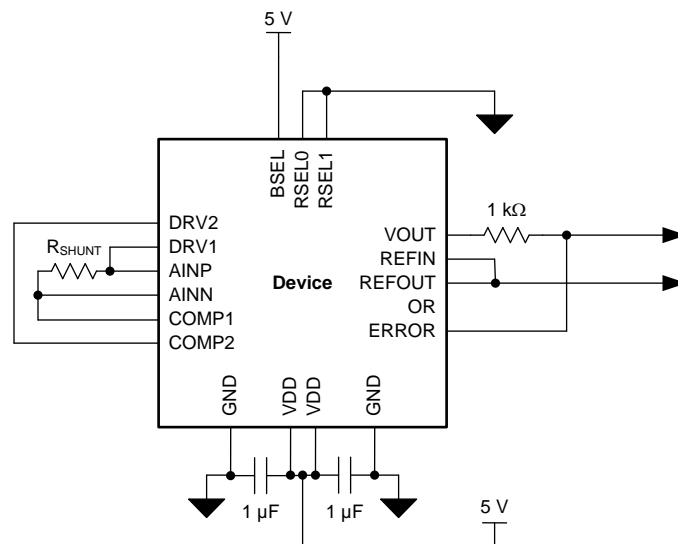

**Figure 64. Field Overage Detection Using a Combined VOUT and ERROR Pin**

## Feature Description (continued)

### 7.3.2 Shunt-Sense Amplifier

The compensation coil current creates a voltage drop across the external shunt resistor,  $R_{SHUNT}$ . The internal differential amplifier senses this voltage drop. This differential amplifier offers wide bandwidth and a high slew rate. Excellent dc stability and accuracy result from a chopping technique. The voltage gain is 4 V/V, set by precisely-matched and thermally-stable internal resistors.

Both the AINN and AINP differential amplifier inputs are connected to the external shunt resistor. This shunt resistor, in series with the internal 10-k $\Omega$  input resistors of the shunt sense amplifier, causes an additional gain error. Therefore, for best common-mode rejection performance, place a dummy shunt resistor ( $R_5$ ) with a value higher than the shunt resistor in series with the REFIN pin to restore the matching of both resistor dividers, as shown in [Figure 65](#).

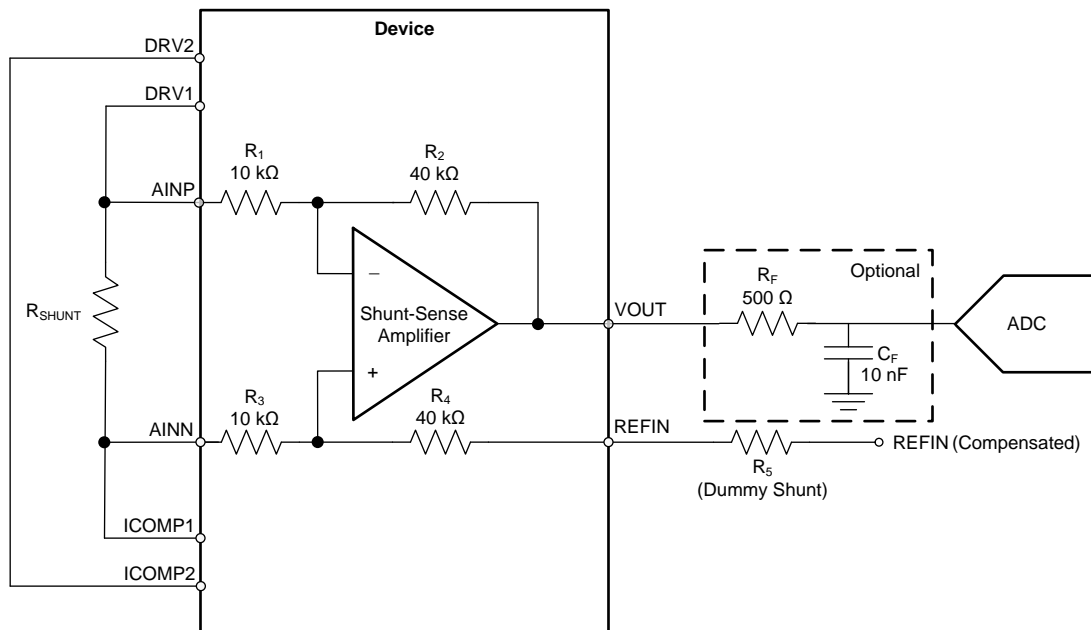

**Figure 65. Internal Difference Amplifier with an Example of a Decoupling Filter**

For an overall gain of 4 V/V, calculate the value of  $R_5$  using [Equation 6](#):

$$4 = \frac{R_2}{R_1} = \frac{R_4 + R_5}{R_{SHUNT} + R_3}$$

where:

- $R_2 / R_1 = R_4 / R_3 = 4$ ,
- $R_5 = R_{SHUNT} \times 4$

(6)

If the input signal is large, the amplifier output drives close to the supply rails. The amplifier output is able to drive the input of a successive approximation register (SAR) analog-to-digital converter (ADC). For best performance, add an RC low-pass filter stage between the shunt-sense amplifier output and the ADC input. This filter limits the noise bandwidth and decouples the high-frequency sampling noise of the ADC input from the amplifier output. For filter resistor  $R_F$  and filter capacitor  $C_F$  values, see the specific converter recommendations in the respective product data sheet.

The shunt-sense amplifier output drives 100 pF directly and shows a 50% overshoot with a 1-nF capacitance. Filter resistor  $R_F$  extends the capacitive load range. Note that with an  $R_F$  of only 20  $\Omega$ , the load capacitor must be either less than 1 nF or more than 33 nF to avoid overshoot; with an  $R_F$  of 50  $\Omega$ , this transient area is avoided.

## Feature Description (continued)

Reference input REFIN is the common-mode voltage node for the output signal VOUT. Use the internal voltage reference of the DRV425 by connecting the REFIN pin to the reference output REFOUT. To avoid mismatch errors, use the same reference voltage for REFIN and the ADC. Alternatively, use an ADC with a pseudo-differential input, with the positive input of the ADC connected to VOUT and the negative input connected to REFIN of the DRV425.

### 7.3.3 Voltage Reference

The internal precision voltage reference circuit offers low-drift performance at the REFOUT output pin and is used for internal biasing. The reference output is intended to be the common-mode voltage of the output (the VOUT pin) to provide a bipolar signal swing. This low-impedance output tolerates sink and source currents of  $\pm 5$  mA. However, fast load transients can generate ringing on this line. A small series resistor of a few ohms improves the response, particularly for capacitive loads equal to or greater than 1  $\mu$ F.

Adjust the value of the voltage reference output to the power supply of the DRV425 using mode selection pins RSEL0 and RSEL1, as shown in [Table 1](#).

**Table 1. Reference Output Voltage Selection**

MODE	RSEL1	RSEL0	DESCRIPTION
$V_{REFOUT} = 2.5$ V	0	0	Use with a sensor module supply of 5 V
$V_{REFOUT} = 1.65$ V	0	1	Use with a sensor module supply of 3.3 V
Ratiometric output	1	x	Provides an output centered on $VDD / 2$

In ratiometric output mode, an internal resistor divider divides the power-supply voltage by a factor of two.

### 7.3.4 Low-Power Operation of the DRV425

In applications with low-bandwidth or low sample-rate requirements, the average power dissipation of the DRV425 can be significantly reduced by powering the device down between measurements. The DRV425 requires 300  $\mu$ s to fully settle the analog output VOUT, as shown in [Figure 66](#). To minimize power dissipation, the device can be powered down immediately after acquiring the sample by the ADC.

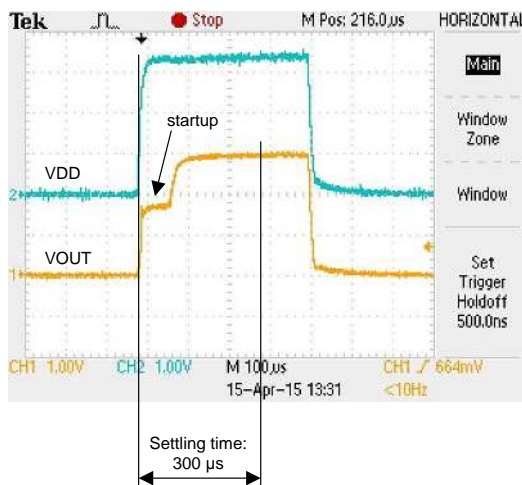

**Figure 66. Settling Time of the DRV425 Output VOUT**

## 7.4 Device Functional Modes

The DRV425 is operational when the power supply VDD is applied, as specified in the [Specifications](#) section. The DRV425 has no additional functional modes.

## 8 Application and Implementation

### NOTE

Information in the following applications sections is not part of the TI component specification, and TI does not warrant its accuracy or completeness. TI's customers are responsible for determining suitability of components for their purposes. Customers should validate and test their design implementation to confirm system functionality.

### 8.1 Application Information

The DRV425 is a high-sensitivity and high-performance magnetic-field sensor. The analog output of the DRV425 can be processed by a 12- to 16-bit analog to digital converter (ADC). The following sections show examples of DRV425-based applications.

### 8.2 Typical Applications

#### 8.2.1 Linear Position Sensing

The high sensitivity of the fluxgate sensor, combined with the high linearity of the compensation loop and low noise of the DRV425, make the device suitable for high-performance linear-position sense applications. A typical schematic of such a 5-V application using an internal 2.5-V reference is shown in [Figure 67](#).

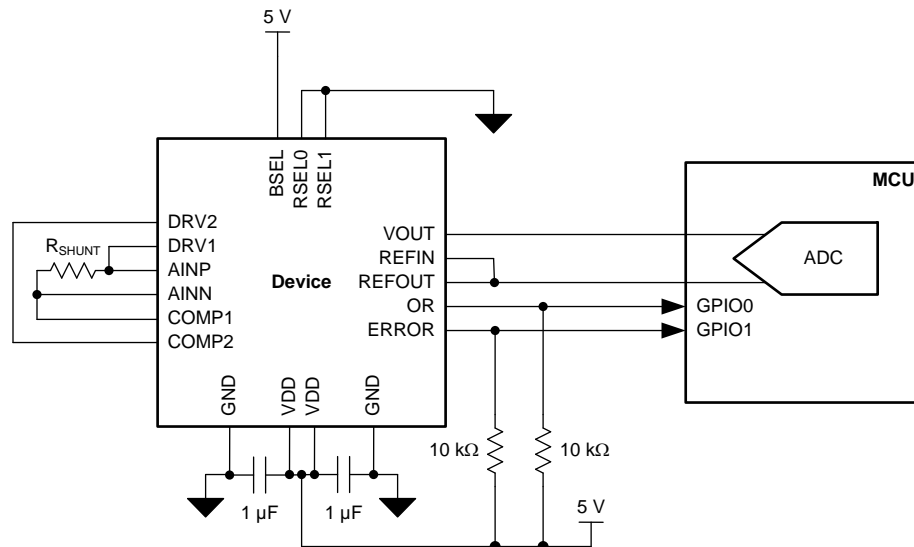

Figure 67. Simplified Schematic of a DRV425-Based Linear-Position Sensing Application

#### 8.2.1.1 Design Requirements

For the example shown in [Figure 67](#), use the parameters listed in [Table 2](#) as a starting point of the design.

Table 2. Design Parameters

DESIGN PARAMETER	EXAMPLE VALUE
Magnetic field range	VDD = 5 V: ±2 mT (max) VDD = 3.3 V: ±1.3 mT (max)
Supply voltage, VDD	3.0 V to 5.5 V
Reference voltage, V <sub>REFIN</sub>	Range: GND to VDD If an internal reference is used: 2.5 V, 1.65 V, or VDD / 2
Shunt resistor, R <sub>SHUNT</sub>	Depends on the desired magnetic field range, reference, and supply voltage; see the <i>DRV425 System Parameter Calculator</i> , <a href="#">SLOC331</a> for details.



### 8.2.1.2 Detailed Design Procedure

Use the following procedure to design a solution for a linear-position sensor based on the DRV425:

- Select the proper supply voltage VDD to support the desired magnetic field range (see Table 2 for reference).
- Select the proper reference voltage V<sub>REFIN</sub> to support the desired magnetic field range and to match the input voltage specifications of the desired ADC.
- Use the DRV425 System Parameter Calculator, SLOC331 (RangeCalculator tab) to select the proper shunt resistor value of R<sub>SHUNT</sub>.
- The sensitivity drift performance of a DRV425-based linear position sensor is dominated by the temperature coefficient of the external shunt resistor. Select a low-drift shunt resistor for best sensor performance.
- Use the DRV425 System Parameter Calculator, SLOC331 (Problems Detected Table in DRV425 System Parameters tab) to verify the system response.

The amplitude of the magnetic field is a function of distance to and the shape of the magnet, as shown in Figure 69. If the magnetic field to be measured exceeds 3.6 mT, see the datasheet of the magnet to calculate the appropriate minimum distance to the DRV425 to avoid saturating the fluxgate sensor.

The high sensitivity of the DRV425 may require shielding of the sensing area to avoid influence of undesired magnetic field sources (such as the earth magnetic field). Alternatively, an additional DRV425 can be used to perform difference measurement to cancel the influence of a static magnetic field source, as shown in Figure 68. Figure 70 shows the differential voltage generated by two DRV425 devices in such a circuit.

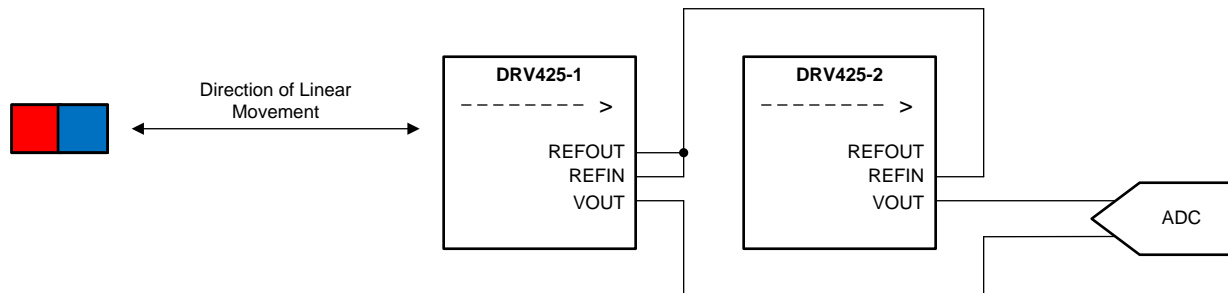
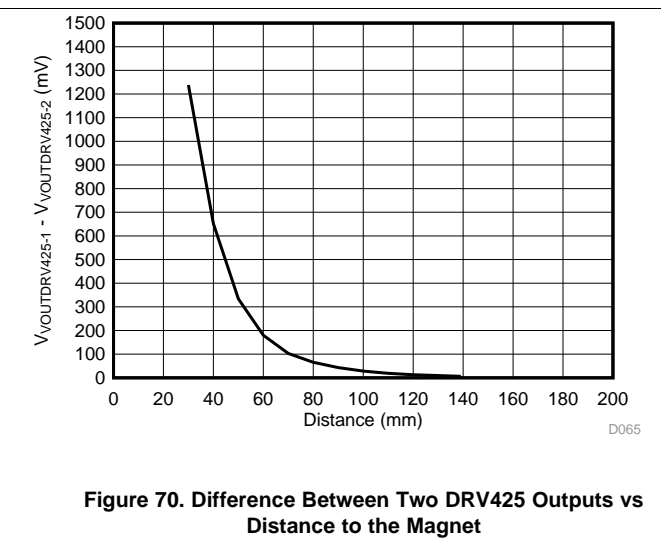
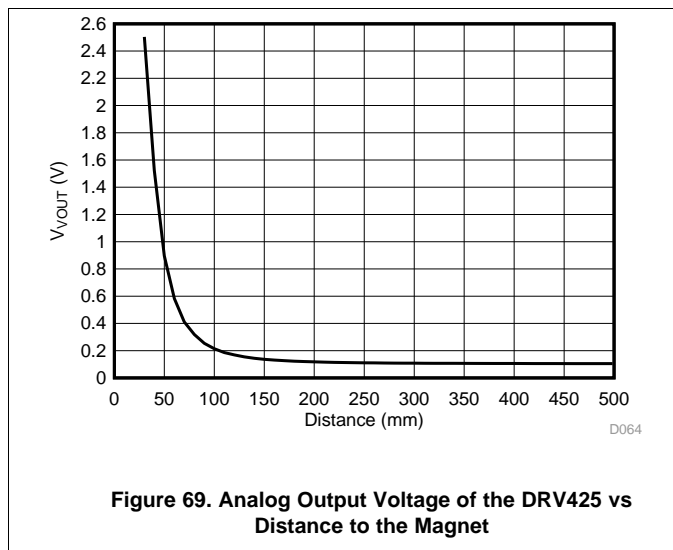

Figure 68. Differential Linear-Position Sensing Using Two DRV425 Devices

### 8.2.1.3 Application Curves



### 8.2.2 Current Sensing in Busbars

In existing applications that use busbars for power distribution, closed-loop current modules are usually used to accurately measure and control the current. These modules are usually bulky because of the required large magnetic core. Additionally, because the compensation current generated inside the module is proportional to the usually high busbar current, the power dissipation of this solution is usually as high as several watts.

Figure 71 shows an alternative approach with two DRV425 devices. If a hole is drilled in the middle of the busbar, the current is split in two equal parts that generate magnetic field gradients with opposite directions inside the hole. These magnetic fields are termed  $B_R$  and  $B_L$  in Figure 72. The opposite fields cancel each other out in the middle of the hole. The high sensitivity and linearity of two DRV425 devices positioned at the same distance from the middle of the hole allow the small opposite fields to be sensed and the current measured with high-accuracy levels. The differential measurement rejects outside fields that generate a common-mode error that is subtracted at the output.

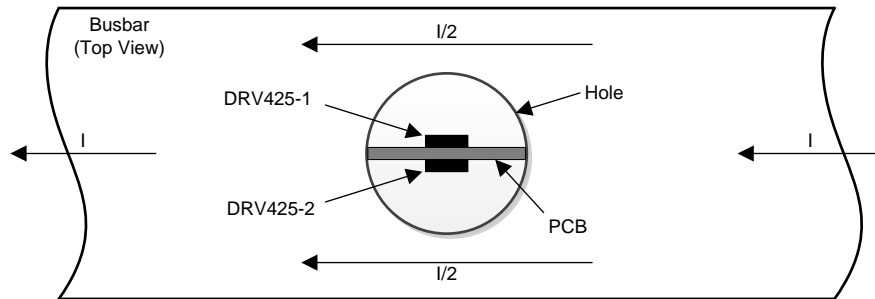

Figure 71. DRV425-Based Busbar Current Sensing

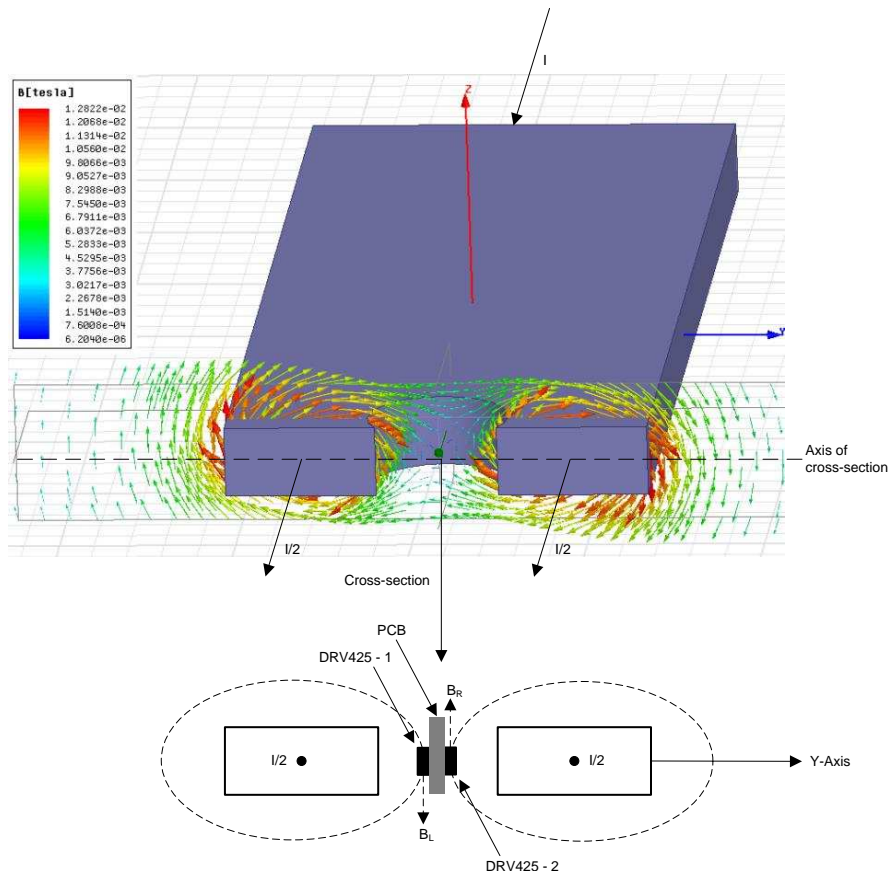

Figure 72. Magnetic Field Distribution Inside a Busbar Hole

### 8.2.2.1 Design Requirements

In order to measure the field gradient in the busbar, two DRV425 sensors are placed inside the hole at a well-defined distance by mounting them on opposite sides of a PCB that is inserted in the hole. The measurement range and resolution of this solution depends on the following factors:

- Busbar geometry: a wider busbar means a larger measurement range and lower resolution.
- Size of the hole: a larger diameter means a larger measurement range and lower resolution.
- Distance between the two DRV425 sensors: a smaller distance increases the measurement range and resolution.

Each of these factors can be optimized to create the desired measurement range for a particular application. Measurement ranges of  $\pm 250$  A to  $\pm 1500$  A are achievable with this approach. Larger currents are supported with large busbar structures and minimized distance between the two DRV425 sensors. Use the parameters listed in [Table 3](#) as a starting point of the design.

**Table 3. Design Parameters**

DESIGN PARAMETER	EXAMPLE VALUE
Current range	Up to $\pm 1500$ A
Supply voltage, VDD	3.0 V to 5.5 V
Reference voltage, $V_{REFIN}$	VDD / 2

### 8.2.2.2 Detailed Design Procedure

Figure 73 shows the schematic diagram of a differential gradient field measurement circuit.

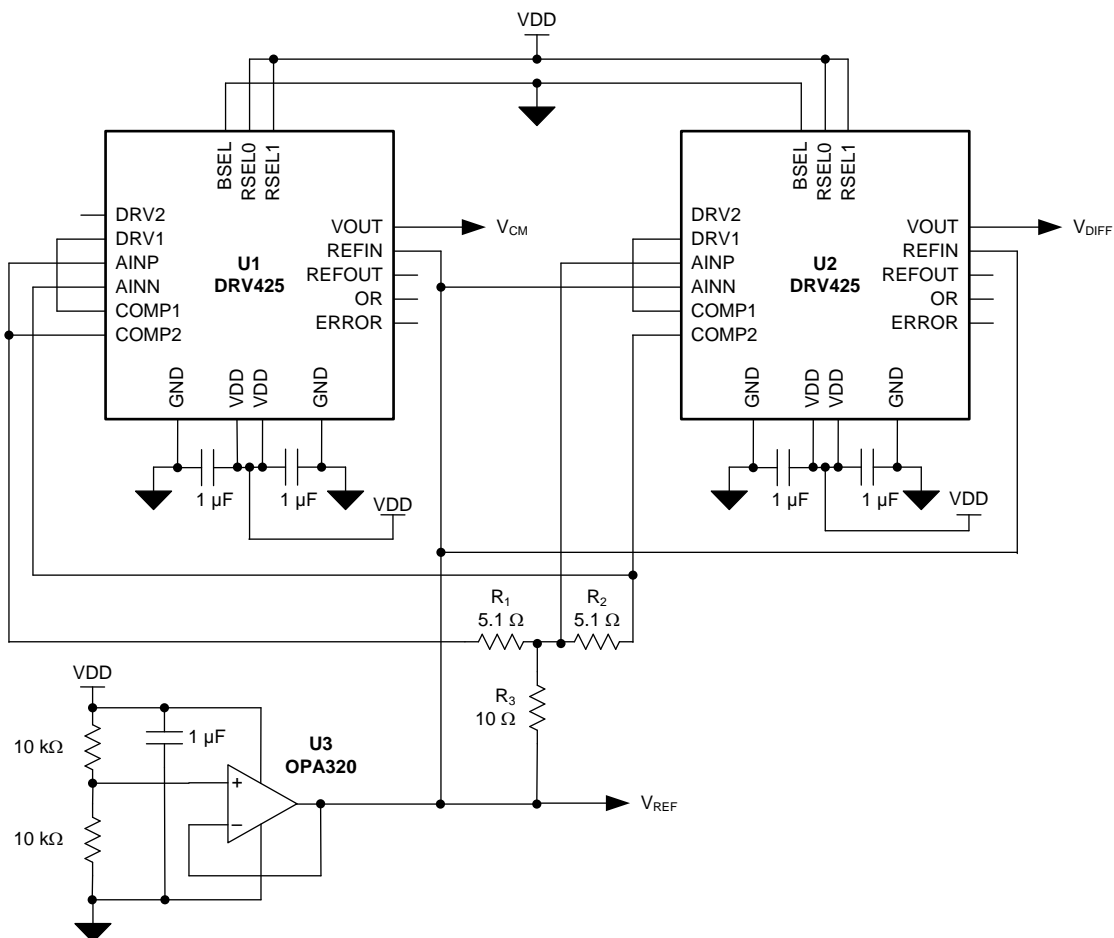

**Figure 73. Schematic of a DRV425-Based Busbar Current-Sensing Circuit**

In [Figure 73](#), the feedback loops of both DRV425 sensors are combined to directly produce a differential output  $V_{DIFF}$  that is proportional to the sensed magnetic field difference inside the busbar hole. Both compensation coils are connected in series and are driven from a single side of the compensation coil driver (the DRV1 pins of each DRV425). Therefore, both driver stages ensure that a current proportional to the magnetic fields  $B_R$  and  $B_L$  is driven through the respective compensation coil. The difference in current through both compensation coils, and thus the difference field between the sensors, flows through resistor  $R_3$  and is sensed by the shunt-sense amplifier of U2. The current proportional to the common-mode field inside the busbar hole flows through  $R_1$  and  $R_2$  and is sensed by the shunt-sense amplifier of U1.

Use the output  $V_{CM}$  to verify that the sensors are correctly positioned in the busbar hole with the following steps:

1. Measure  $V_{CM}$  with no current flow through the busbar and the PCB in the middle of the busbar hole. This value is the offset voltage  $V_{OFFSET}$ . The value of  $V_{OFFSET}$  only depends on stray fields and varies little with the absolute position of the sensors.
2. Apply current through the busbar and move the PCB along the y-axis in the busbar hole, as shown in [Figure 72](#). The PCB is in the center of the hole if  $V_{CM} = V_{OFFSET}$ .

The sensitivity drift performance of the circuit shown in [Figure 73](#) is dominated by the temperature coefficient of the external resistors  $R_1$ ,  $R_2$ , and  $R_3$ . Select low-drift resistors for best sensor performance. For overall system error calculation, also consider the affect of thermal expansion on the PCB and busbar.

The internal voltage reference of the DRV425 cannot be used in this application because of its limited driver capability. The [OPA320](#) (U3) is a low-noise operational amplifier with a short-circuit current capability of  $\pm 65$  mA and is used to support the required compensation current.

The advantage of this solution is its simplicity: the currents are subtracted by the two DRV425 devices without additional components. The series connection of the compensation coils halves the voltage swing and reduces the measurement range of the sensors also by 50%. If a larger sensing range is required, operate the two sensors independently and use a differential amplifier or ADC to subtract both voltage outputs (VOUT).

Use the ERROR outputs for fast overcurrent detection on the system level.

### 8.2.2.3 Application Curves

[Figure 74](#) and [Figure 75](#) show the measurement results on a 16-mm wide and 6-mm thick copper busbar with a 12-mm hole diameter using the circuit shown in [Figure 73](#). The two DRV425 devices are placed at a distance of 1 mm from each other on opposite sides of the PCB. The measurement range is  $\pm 500$  A; measurement results are limited by test setup. Independent operation of the two DRV425 sensors increases the measurement range to  $\pm 1000$  A with the same busbar geometry.

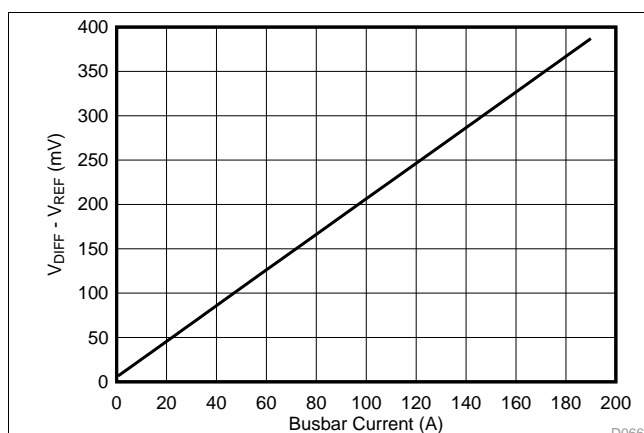

**Figure 74. Analog Output Voltage vs Busbar Current**

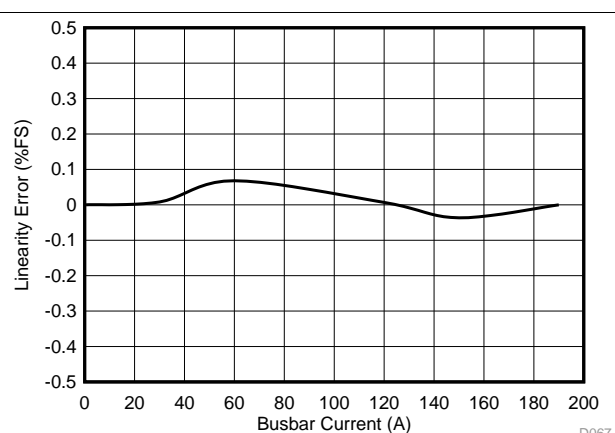

**Figure 75. Linearity Error vs Busbar Current**

## 9 Power-Supply Recommendations

### 9.1 Power-Supply Decoupling

Decouple both VDD pins of the DRV425 with 1- $\mu$ F, X7R-type ceramic capacitors to the adjacent GND pin as illustrated in [Figure 76](#). For best performance, place both decoupling capacitors as close to the related power-supply pins as possible. Connect these capacitors to the power-supply source in a way that allows the current to flow through the pads of the decoupling capacitors.

### 9.2 Power-On Start-Up and Brownout

Power-on is detected when the supply voltage exceeds 2.4 V at the VDD pin. At this point, the DRV425 initiates the following start-up sequence:

1. Digital logic starts up and waits for 26  $\mu$ s for the supply to settle.
2. The fluxgate sensor powers up.
3. The compensation loop is active 70  $\mu$ s after the supply voltage exceeds 2.4 V.

During this startup sequence, the DRV1 and DRV2 outputs are pulled low to prevent undesired signals on the compensation coil and the ERROR pin is asserted low.

The DRV425 tests for low supply voltages with a brownout voltage level of 2.4 V. Use a power-supply source capable of supporting large current pulses driven by the DRV425, and low-ESR bypass capacitors for a stable supply voltage in the system. A supply drop below 2.4 V that lasts longer than 20  $\mu$ s generates a power-on reset; the device ignores shorter voltage drops. A voltage drop on the VDD pin to below 1.8 V immediately initiates a power-on reset. After the power supply returns to 2.4 V, the device initiates a start-up cycle.

### 9.3 Power Dissipation

The thermally-enhanced, PowerPAD, WQFN package reduces the thermal impedance from junction to case. This package has a downset lead frame that the die is mounted to. The lead frame has an exposed thermal pad (PowerPAD) on the underside of the package, and provides a good thermal path for heat dissipation.

The power dissipation on both linear outputs DRV1 and DRV2 is calculated with [Equation 7](#):

$$P_{D(DRV)} = I_{DRV} \times (V_{DRV} - V_{SUPPLY})$$

where

- $I_{DRV}$  = supply current as shown in [Figure 59](#),
  - $V_{DRV}$  = voltage potential on the DRV1 or DRV2 output pin, and
  - $V_{SUPPLY}$  = voltage potential closer to  $V_{DRV}$ : VDD or GND
- (7)

#### 9.3.1 Thermal Pad

Packages with an exposed thermal pad are specifically designed to provide excellent power dissipation, but board layout greatly influences the overall heat dissipation. Technical details are described in application report *PowerPad Thermally Enhanced Package*, [SLMA002](#), available for download at [www.ti.com](http://www.ti.com).

## 10 Layout

### 10.1 Layout Guidelines

The unique, integrated fluxgate of the DRV425 has a very high sensitivity to enable designing a closed-loop magnetic-field sensor with best-in-class precision and linearity. Observe proper PCB layout techniques because any current-conducting wire in the direct vicinity of the DRV425 generates a magnetic field that can distort measurements. Common passive components and some PCB plating materials contain ferromagnetic materials that are magnetizable. For best performance, use the following layout guidelines:

- Route current-conducting wires in pairs: route a wire with an incoming supply current next to, or on top of, its return current path. The opposite magnetic field polarity of these connections cancel each other. To facilitate this layout approach, the DRV425 positive and negative supply pins are located next to each other.
- Route the compensation coil connections close to each other as a pair to reduce coupling effects.
- Minimize the length of the compensation coil connections between the DRV1/2 and COMP1/2 pins.
- Route currents parallel to the fluxgate sensor sensitivity axis as illustrated in [Figure 76](#). As a result, magnetic fields are perpendicular to the fluxgate sensitivity and have limited effect.
- Vertical current flow (for example, through vias) generates a field in the fluxgate-sensitive direction. Minimize the number of vias in the vicinity of the DRV425.
- Use nonmagnetic passive components (for example, decoupling capacitors and the shunt resistor) to prevent magnetizing effects near the DRV425.
- Do not use PCB trace finishes with nickel-gold plating because of the potential for magnetization.
- Connect all GND pins to a local ground plane.

Ferrite beads in series to the power-supply connection reduce interaction with other circuits powered from the same supply voltage source. However, to prevent influence of the magnetic fields if ferrite beads are used, do not place them next to the DRV425.

The reference output (the REFOUT pin) refers to GND. Use a low-impedance and star-type connection to reduce the driver current and the fluxgate sensor current modulating the voltage drop on the ground track. The REFOUT and VOUT outputs are able to drive some capacitive load, but avoid large direct capacitive loading because of increased internal pulse currents. Given the wide bandwidth of the shunt-sense amplifier, isolate large capacitive loads with a small series resistor.

Solder the exposed PowerPAD on the bottom of the package to the ground layer because the PowerPAD is internally connected to the substrate that must be connected to the most-negative potential.

[Figure 76](#) illustrates a generic layout example that highlights the placement of components that are critical to the DRV425 performance. For specific layout examples, see the *DRV425EVM Users Guide*, [SLOU410](#).

## 10.2 Layout Example

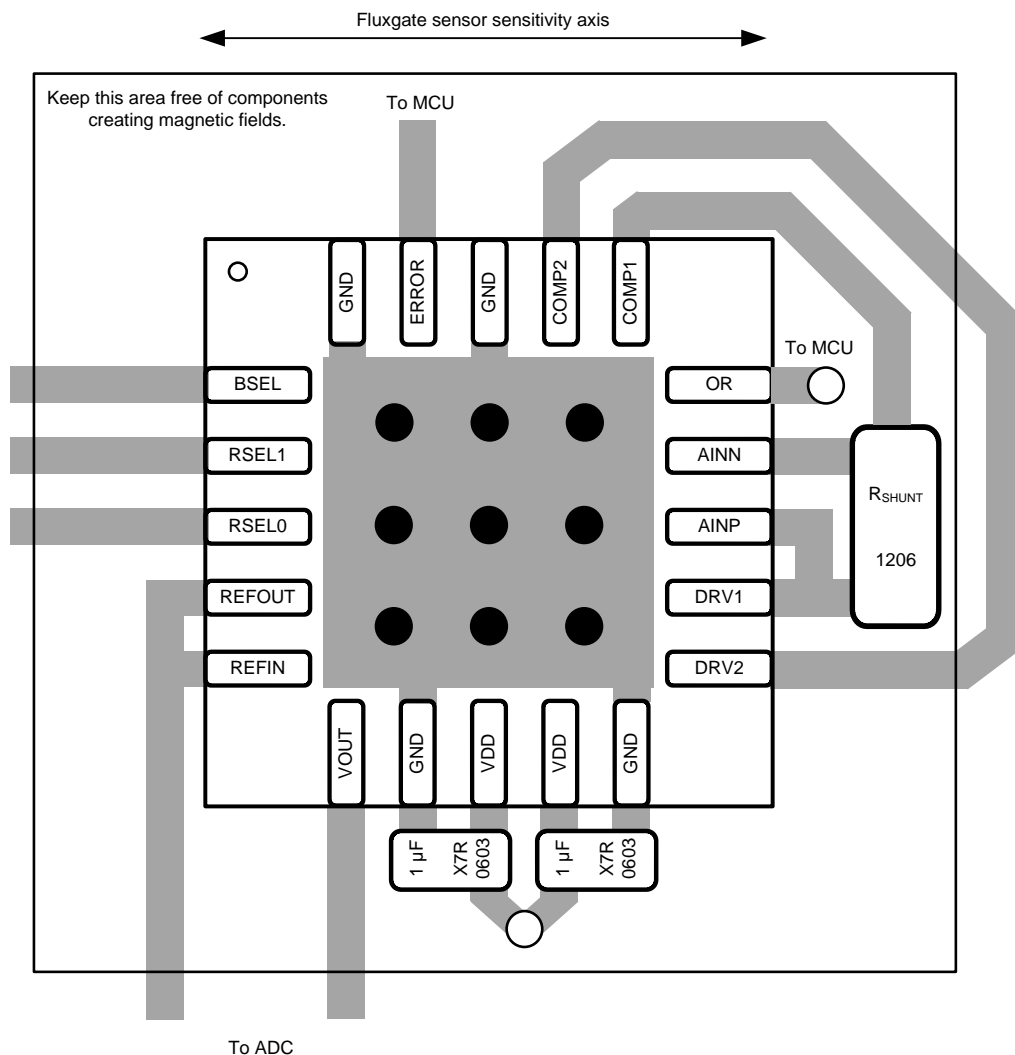

Figure 76. Generic Layout Example (Top View)

## 11 Device and Documentation Support

### 11.1 Documentation Support

#### 11.1.1 Related Documentation

OPA320 Data Sheet, [SBOS513](#)

DRV425EVM Users Guide, [SLOU410](#)

*DRV425 System Parameter Calculator*, [SLOC331](#)

*PowerPad Thermally Enhanced Package*, [SLMA002](#)

### 11.2 Community Resources

The following links connect to TI community resources. Linked contents are provided "AS IS" by the respective contributors. They do not constitute TI specifications and do not necessarily reflect TI's views; see TI's [Terms of Use](#).

**TI E2E™ Online Community** *TI's Engineer-to-Engineer (E2E) Community*. Created to foster collaboration among engineers. At [e2e.ti.com](http://e2e.ti.com), you can ask questions, share knowledge, explore ideas and help solve problems with fellow engineers.

**Design Support** *TI's Design Support* Quickly find helpful E2E forums along with design support tools and contact information for technical support.

### 11.3 Trademarks

PowerPAD, E2E are trademarks of Texas Instruments.  
All other trademarks are the property of their respective owners.

### 11.4 Electrostatic Discharge Caution



This integrated circuit can be damaged by ESD. Texas Instruments recommends that all integrated circuits be handled with appropriate precautions. Failure to observe proper handling and installation procedures can cause damage.

ESD damage can range from subtle performance degradation to complete device failure. Precision integrated circuits may be more susceptible to damage because very small parametric changes could cause the device not to meet its published specifications.

### 11.5 Glossary

[SLYZ022](#) — *TI Glossary*.



This glossary lists and explains terms, acronyms, and definitions.

## 12 Mechanical, Packaging, and Orderable Information

The following pages include mechanical, packaging, and orderable information. This information is the most current data available for the designated devices. This data is subject to change without notice and revision of this document. For browser-based versions of this data sheet, refer to the left-hand navigation.



**PACKAGING INFORMATION**

Orderable Device	Status (1)	Package Type	Package Drawing	Pins	Package Qty	Eco Plan (2)	Lead finish/ Ball material (6)	MSL Peak Temp (3)	Op Temp (°C)	Device Marking (4/5)	Samples
DRV425RTJR	ACTIVE	QFN	RTJ	20	3000	RoHS & Green	Call TI	Level-3-260C-168 HR	-40 to 125	-----> DRV425	
DRV425RTJT	ACTIVE	QFN	RTJ	20	250	RoHS & Green	Call TI	Level-3-260C-168 HR	-40 to 125	-----> DRV425	

(1) The marketing status values are defined as follows:

**ACTIVE:** Product device recommended for new designs.

**LIFEBUY:** TI has announced that the device will be discontinued, and a lifetime-buy period is in effect.

**NRND:** Not recommended for new designs. Device is in production to support existing customers, but TI does not recommend using this part in a new design.

**PREVIEW:** Device has been announced but is not in production. Samples may or may not be available.

**OBSOLETE:** TI has discontinued the production of the device.

(2) **RoHS:** TI defines "RoHS" to mean semiconductor products that are compliant with the current EU RoHS requirements for all 10 RoHS substances, including the requirement that RoHS substance do not exceed 0.1% by weight in homogeneous materials. Where designed to be soldered at high temperatures, "RoHS" products are suitable for use in specified lead-free processes. TI may reference these types of products as "Pb-Free".

**RoHS Exempt:** TI defines "RoHS Exempt" to mean products that contain lead but are compliant with EU RoHS pursuant to a specific EU RoHS exemption.

**Green:** TI defines "Green" to mean the content of Chlorine (Cl) and Bromine (Br) based flame retardants meet JS709B low halogen requirements of <=1000ppm threshold. Antimony trioxide based flame retardants must also meet the <=1000ppm threshold requirement.

(3) MSL, Peak Temp. - The Moisture Sensitivity Level rating according to the JEDEC industry standard classifications, and peak solder temperature.

(4) There may be additional marking, which relates to the logo, the lot trace code information, or the environmental category on the device.

(5) Multiple Device Markings will be inside parentheses. Only one Device Marking contained in parentheses and separated by a "~" will appear on a device. If a line is indented then it is a continuation of the previous line and the two combined represent the entire Device Marking for that device.

(6) Lead finish/Ball material - Orderable Devices may have multiple material finish options. Finish options are separated by a vertical ruled line. Lead finish/Ball material values may wrap to two lines if the finish value exceeds the maximum column width.

**Important Information and Disclaimer:**The information provided on this page represents TI's knowledge and belief as of the date that it is provided. TI bases its knowledge and belief on information provided by third parties, and makes no representation or warranty as to the accuracy of such information. Efforts are underway to better integrate information from third parties. TI has taken and continues to take reasonable steps to provide representative and accurate information but may not have conducted destructive testing or chemical analysis on incoming materials and chemicals. TI and TI suppliers consider certain information to be proprietary, and thus CAS numbers and other limited information may not be available for release.

In no event shall TI's liability arising out of such information exceed the total purchase price of the TI part(s) at issue in this document sold by TI to Customer on an annual basis.

**OTHER QUALIFIED VERSIONS OF DRV425 :**

- Automotive: [DRV425-Q1](#)

## NOTE: Qualified Version Definitions:

- Automotive - Q100 devices qualified for high-reliability automotive applications targeting zero defects

## GENERIC PACKAGE VIEW

**RTJ 20**

**WQFN - 0.8 mm max height**

4 x 4, 0.5 mm pitch

PLASTIC QUAD FLATPACK - NO LEAD

This image is a representation of the package family, actual package may vary.  
Refer to the product data sheet for package details.

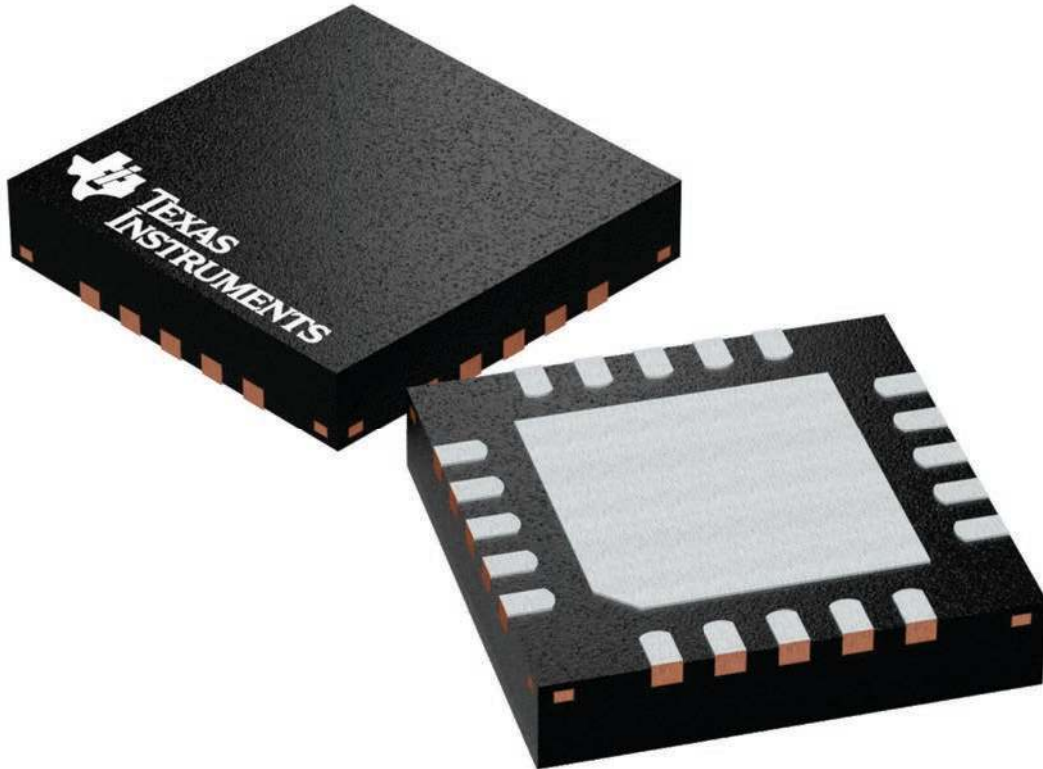

4224842/A

RTJ (S-PWQFN-N20)

PLASTIC QUAD FLATPACK NO-LEAD

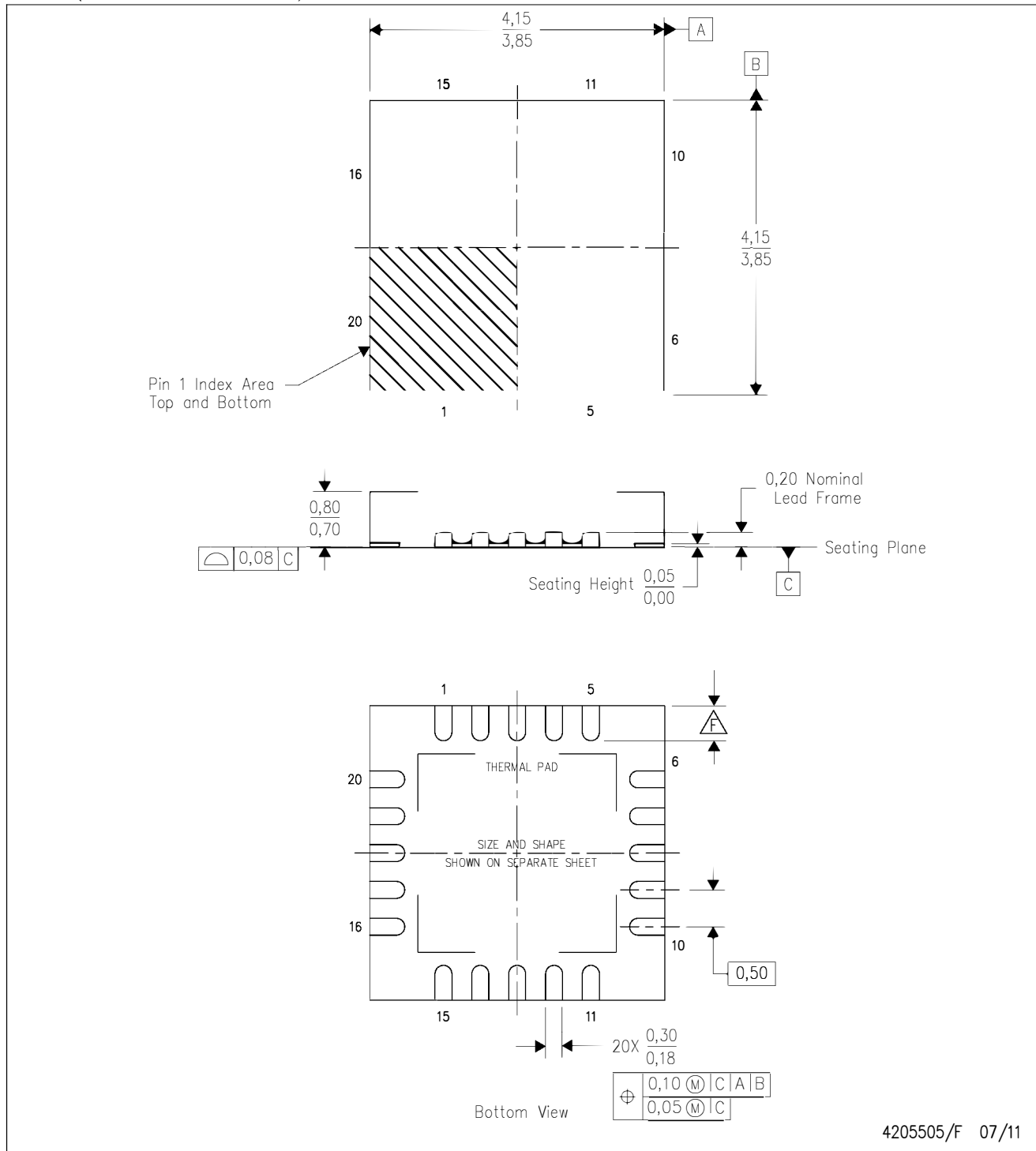

4205505/F 07/11

- NOTES:
- All linear dimensions are in millimeters. Dimensioning and tolerancing per ASME Y14.5-1994.
  - This drawing is subject to change without notice.
  - QFN (Quad Flatpack No-Lead) package configuration.
  - The package thermal pad must be soldered to the board for thermal and mechanical performance.
  - See the additional figure in the Product Data Sheet for details regarding the exposed thermal pad features and dimensions.
  - Check thermal pad mechanical drawing in the product datasheet for nominal lead length dimensions.

RTJ (S-PWQFN-N20)

PLASTIC QUAD FLATPACK NO-LEAD

THERMAL INFORMATION

This package incorporates an exposed thermal pad that is designed to be attached directly to an external heatsink. The thermal pad must be soldered directly to the printed circuit board (PCB). After soldering, the PCB can be used as a heatsink. In addition, through the use of thermal vias, the thermal pad can be attached directly to the appropriate copper plane shown in the electrical schematic for the device, or alternatively, can be attached to a special heatsink structure designed into the PCB. This design optimizes the heat transfer from the integrated circuit (IC).

For information on the Quad Flatpack No-Lead (QFN) package and its advantages, refer to Application Report, QFN/SON PCB Attachment, Texas Instruments Literature No. SLUA271. This document is available at [www.ti.com](http://www.ti.com).

The exposed thermal pad dimensions for this package are shown in the following illustration.

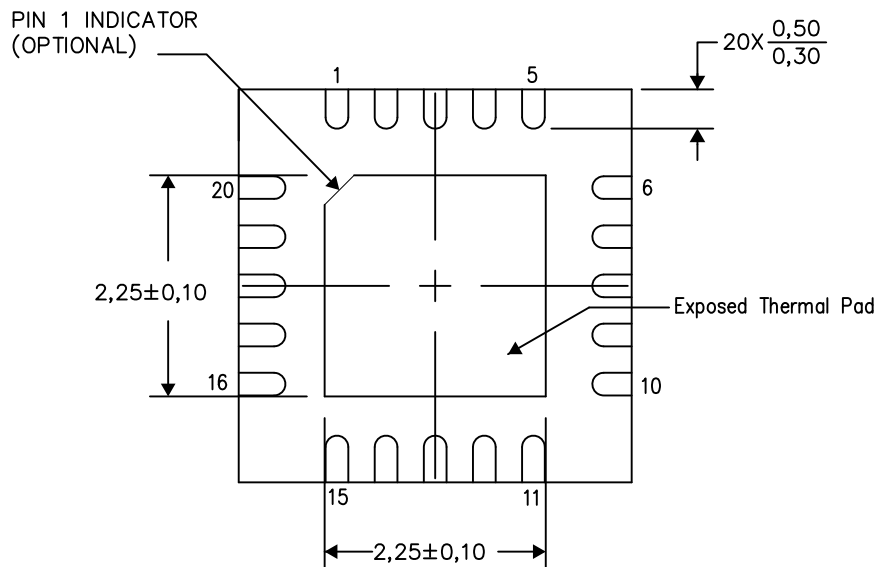

Bottom View

Exposed Thermal Pad Dimensions

4206256-8/V 05/15

NOTE: All linear dimensions are in millimeters

## IMPORTANT NOTICE AND DISCLAIMER

TI PROVIDES TECHNICAL AND RELIABILITY DATA (INCLUDING DATASHEETS), DESIGN RESOURCES (INCLUDING REFERENCE DESIGNS), APPLICATION OR OTHER DESIGN ADVICE, WEB TOOLS, SAFETY INFORMATION, AND OTHER RESOURCES "AS IS" AND WITH ALL FAULTS, AND DISCLAIMS ALL WARRANTIES, EXPRESS AND IMPLIED, INCLUDING WITHOUT LIMITATION ANY IMPLIED WARRANTIES OF MERCHANTABILITY, FITNESS FOR A PARTICULAR PURPOSE OR NON-INFRINGEMENT OF THIRD PARTY INTELLECTUAL PROPERTY RIGHTS.

These resources are intended for skilled developers designing with TI products. You are solely responsible for (1) selecting the appropriate TI products for your application, (2) designing, validating and testing your application, and (3) ensuring your application meets applicable standards, and any other safety, security, or other requirements. These resources are subject to change without notice. TI grants you permission to use these resources only for development of an application that uses the TI products described in the resource. Other reproduction and display of these resources is prohibited. No license is granted to any other TI intellectual property right or to any third party intellectual property right. TI disclaims responsibility for, and you will fully indemnify TI and its representatives against, any claims, damages, costs, losses, and liabilities arising out of your use of these resources.

TI's products are provided subject to TI's Terms of Sale (<https://www.ti.com/legal/termsofsale.html>) or other applicable terms available either on [ti.com](https://www.ti.com) or provided in conjunction with such TI products. TI's provision of these resources does not expand or otherwise alter TI's applicable warranties or warranty disclaimers for TI products.

Mailing Address: Texas Instruments, Post Office Box 655303, Dallas, Texas 75265  
Copyright © 2021, Texas Instruments Incorporated