

YASMEEN-50-M-C

~26° wide beam. Assembly with holder C compatible with LEDiL HEKLA. Black version.

SPECIFICATION:

Dimensions	Ø 49.9 mm
Height	28.1 mm
ROHS compliant	yes ⓘ



MATERIALS:

Component	Type	Material	Colour	Finish
YASMEEN-50-M	Single lens	PMMA	clear	
YASMEEN-50-HLD-C	Holder	PC	black	





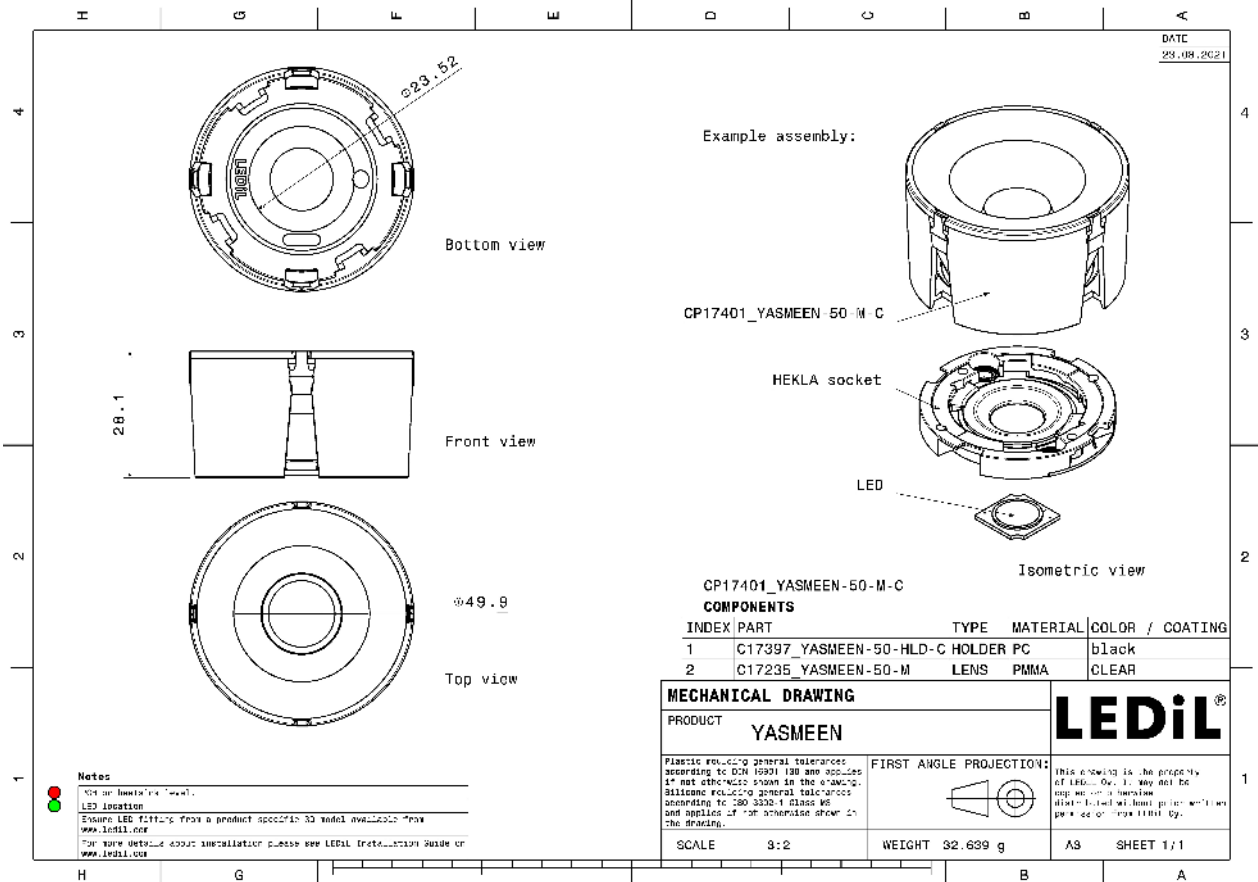



ORDERING INFORMATION:

Component	Type	Qty in box	MOQ	MPQ	Box weight (kg)
CP17401_YASMEEN-50-M-C » Box size: 476 x 273 x 305 mm	Single lens	252	112	28	9.8

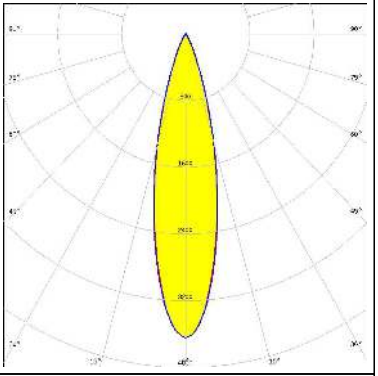

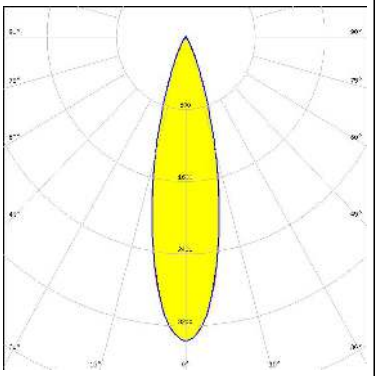

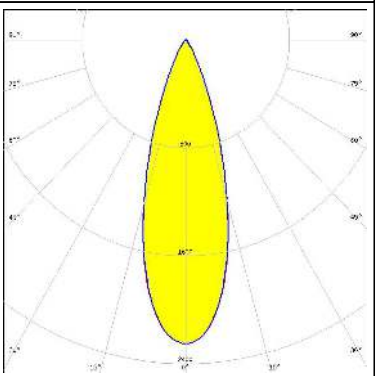

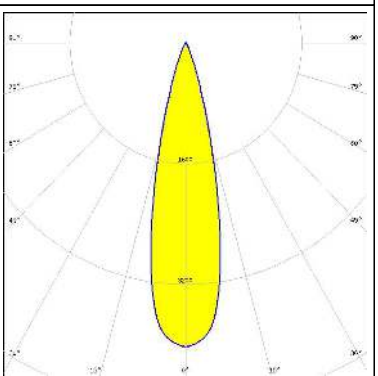



See also our general installation guide: www.ledil.com/installation_guide

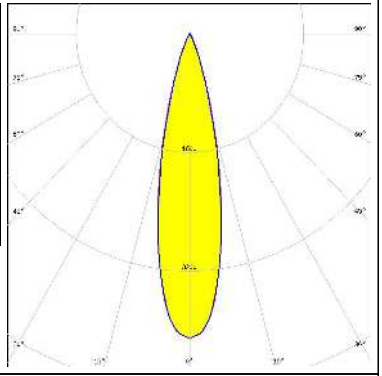

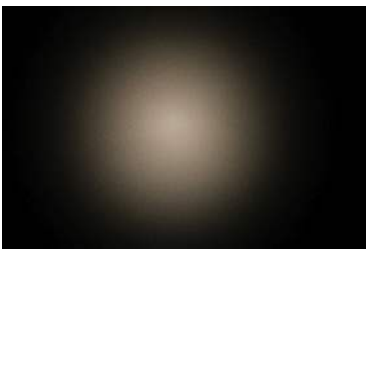
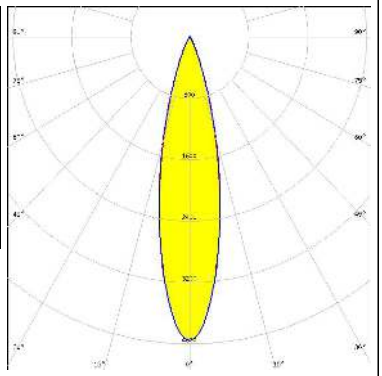

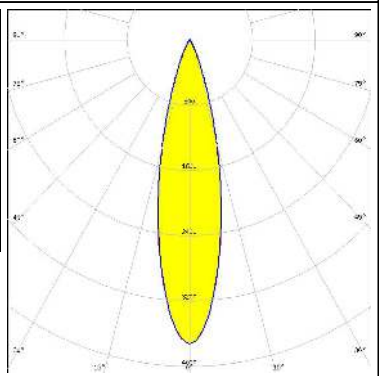

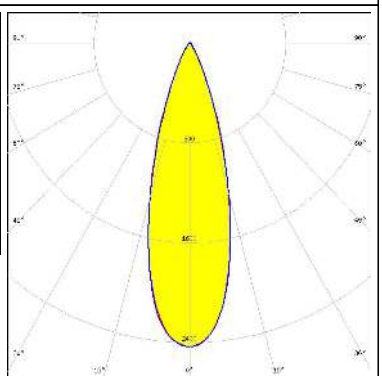
OPTICAL RESULTS (MEASURED):

<p></p> <p>LED V10 Gen 8 FWHM / FWTM 25.0° / 46.0° Efficiency 84 % Peak intensity 3.6 cd/lm LEDs/each optic 1 Light colour White Required components: F15255_HEKLA-SOCKET-C</p>		
<p></p> <p>LED V11 HD Gen 8 FWHM / FWTM 26.0° / 48.0° Efficiency 84 % Peak intensity 3.4 cd/lm LEDs/each optic 1 Light colour White Required components: Bender Wirth: 633d Hekla</p>		
<p></p> <p>LED V13 Gen 8 FWHM / FWTM 32.0° / 56.0° Efficiency 80 % Peak intensity 2.3 cd/lm LEDs/each optic 1 Light colour White Required components: F15859_HEKLA-SOCKET-I</p>		
<p></p> <p>LED V4 HD Gen 7 FWHM / FWTM 25.0° / 42.0° Efficiency 85 % Peak intensity 4 cd/lm LEDs/each optic 1 Light colour White Required components: F15253_HEKLA-SOCKET-A</p>		

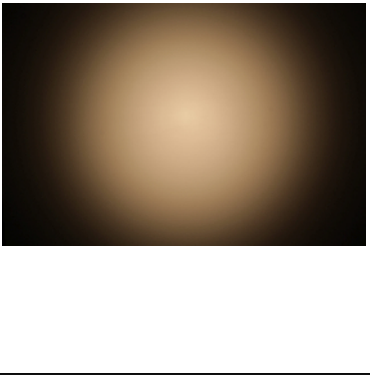
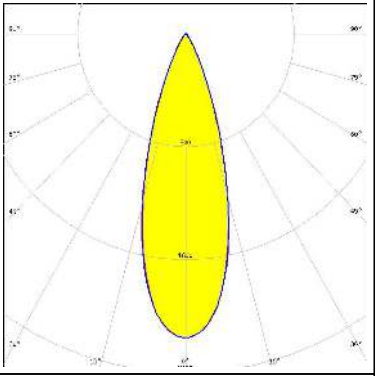
OPTICAL RESULTS (MEASURED):

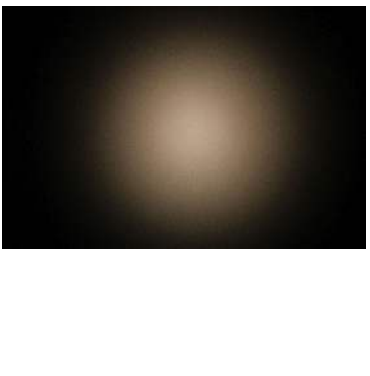
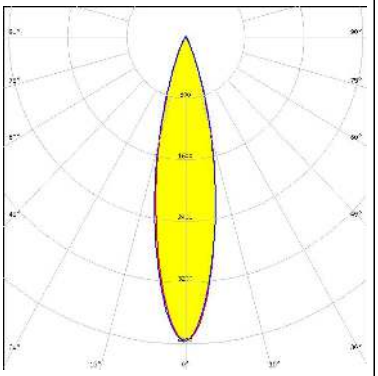
<p></p> <p>LED V6 HD Gen 7</p> <p>FWHM / FWTM 24.0° / 43.0°</p> <p>Efficiency 85 %</p> <p>Peak intensity 4.1 cd/lm</p> <p>LEDs/each optic 1</p> <p>Light colour White</p> <p>Required components: F15255_HEKLA-SOCKET-C</p>		
<p></p> <p>LED V8 Gen 8</p> <p>FWHM / FWTM 24.0° / 45.0°</p> <p>Efficiency 85 %</p> <p>Peak intensity 4 cd/lm</p> <p>LEDs/each optic 1</p> <p>Light colour White</p> <p>Required components: F15253_HEKLA-SOCKET-A</p>		
<p></p> <p>LED VERO10</p> <p>FWHM / FWTM 24.5° / 46.0°</p> <p>Efficiency 84 %</p> <p>Peak intensity 3.7 cd/lm</p> <p>LEDs/each optic 1</p> <p>Light colour White</p> <p>Required components: F15616_HEKLA-SOCKET-F</p>		
<p></p> <p>LED Vesta DTW 13mm (21W)</p> <p>FWHM / FWTM 31.0° / 54.0°</p> <p>Efficiency 80 %</p> <p>Peak intensity 2.4 cd/lm</p> <p>LEDs/each optic 1</p> <p>Light colour Tunable White</p> <p>Required components: Bender Wirth: 632b Hekla XL</p>		

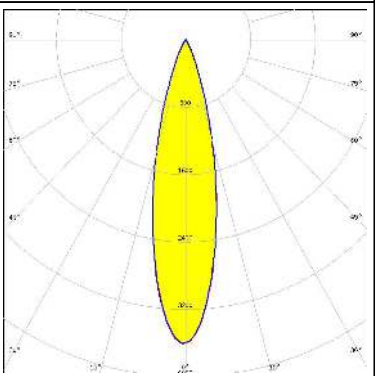
OPTICAL RESULTS (MEASURED):

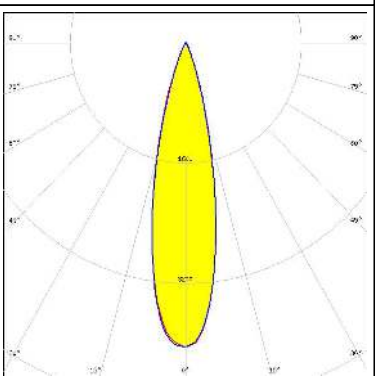
<p></p> <p>LED Vesta DTW 15mm (33W) FWHM / FWTM 33.0° / 57.0° Efficiency 79 % Peak intensity 2.2 cd/lm LEDs/each optic 1 Light colour Tunable White Required components: Bender Wirth: 632b Hekla XL</p>		
<p></p> <p>LED Vesta DTW 9mm (4W/6W/12W) FWHM / FWTM 23.0° / 45.0° Efficiency 84 % Peak intensity 4 cd/lm LEDs/each optic 1 Light colour White Required components: Bender Wirth: 652b Hekla</p>		
<p>CITIZEN</p> <p>LED CLL02x/CLU02x (LES10) FWHM / FWTM 24.0° / 46.0° Efficiency 84 % Peak intensity 3.6 cd/lm LEDs/each optic 1 Light colour White Required components: F17435_HEKLA-G2-C</p>		
<p>CITIZEN</p> <p>LED CLU700/701/702/703 FWHM / FWTM 24.0° / 43.0° Efficiency 85 % Peak intensity 4 cd/lm LEDs/each optic 1 Light colour White Required components: F17435_HEKLA-G2-C</p>		

OPTICAL RESULTS (MEASURED):

CITIZEN

LED CLU7A2/7A3
 FWHM / FWTM 25.0° / 42.0°
 Efficiency 85 %
 Peak intensity 4 cd/m
 LEDs/each optic 1
 Light colour White
 Required components:
 F17435_HEKLA-G2-C

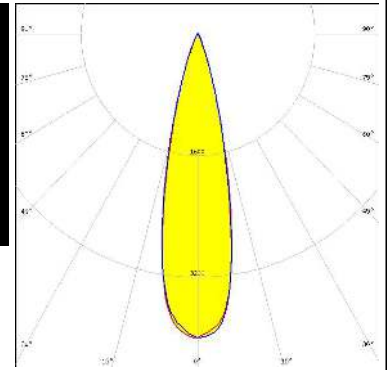

CITIZEN

LED CLU7B2
 FWHM / FWTM 25.0° / 42.0°
 Efficiency 85 %
 Peak intensity 3.9 cd/m
 LEDs/each optic 1
 Light colour White
 Required components:
 F17435_HEKLA-G2-C

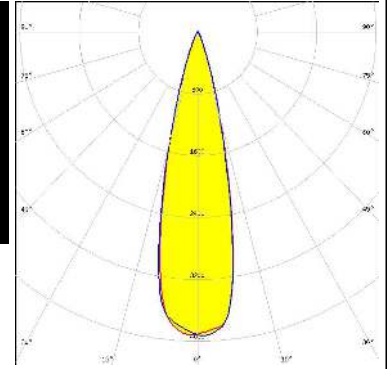
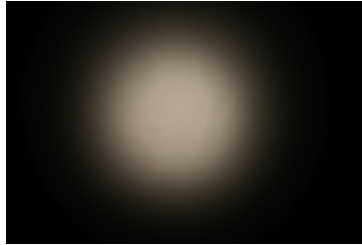

CREE LED

LED CMA1516
 FWHM / FWTM 24.0° / 45.0°
 Efficiency 84 %
 Peak intensity 3.8 cd/m
 LEDs/each optic 1
 Light colour White
 Required components:
 F17436_HEKLA-G2-D

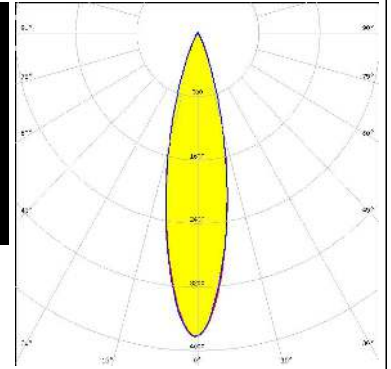



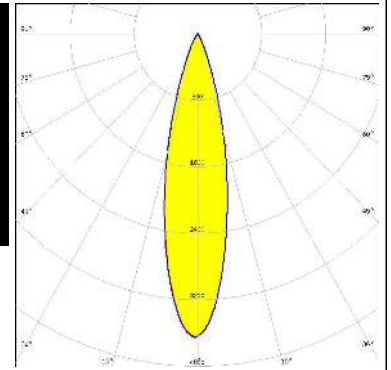
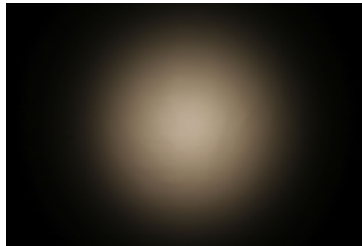

CREE LED



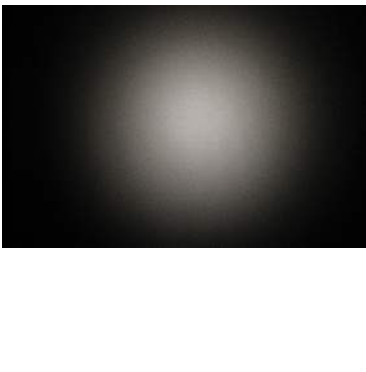
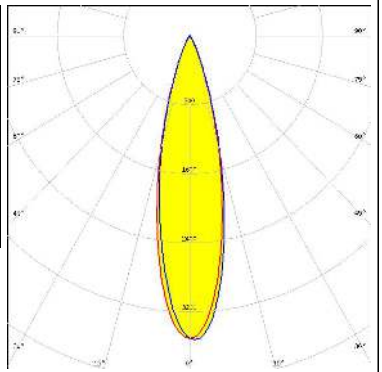

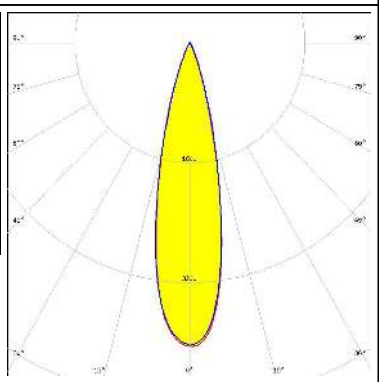

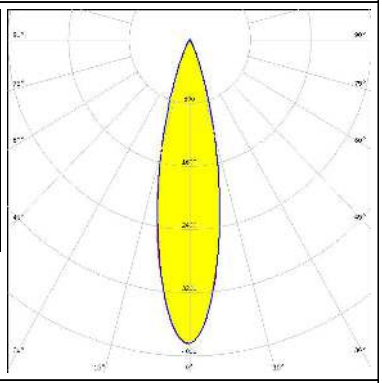
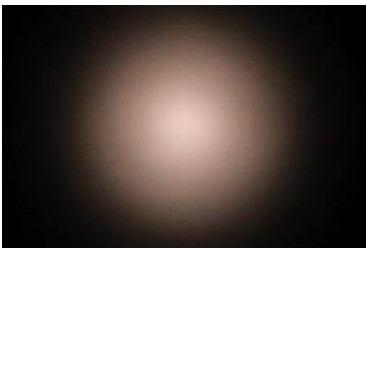
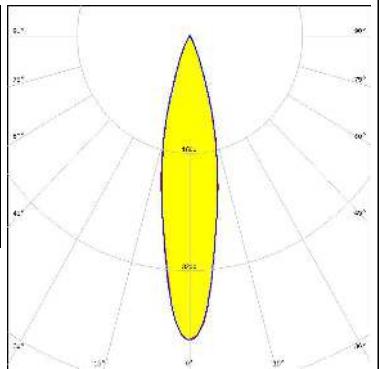
LED CMT14xx
 FWHM / FWTM 24.0° / 46.0°
 Efficiency 84 %
 Peak intensity 3.7 cd/m
 LEDs/each optic 1
 Light colour White
 Required components:
 F17435_HEKLA-G2-C



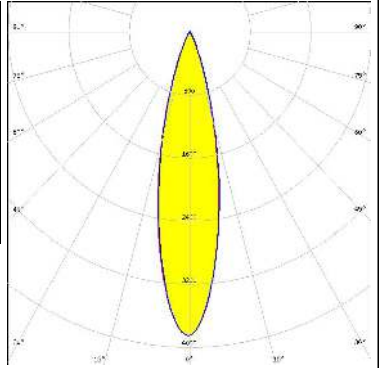

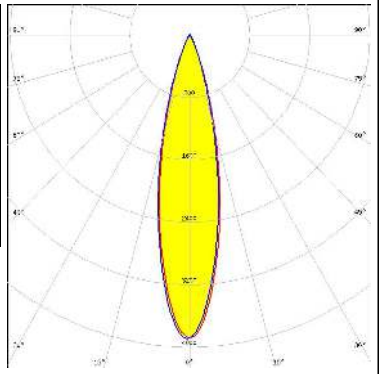

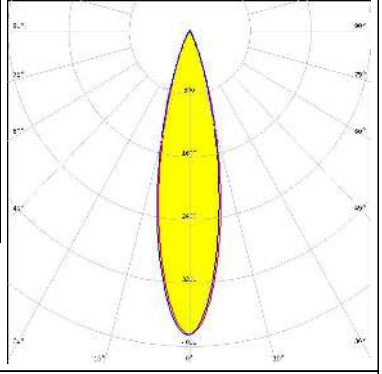
OPTICAL RESULTS (MEASURED):

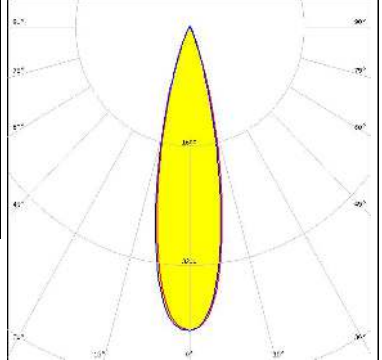
<p>CREE → LED</p> <p>LED CMU10xx FWHM / FWTM 25.0° / 47.0° Efficiency 83 % Peak intensity 3.5 cd/lm LEDs/each optic 1 Light colour White Required components: F17435_HEKLA-G2-C</p>		
<p>CREE → LED</p> <p>LED CXA/B 13xx FWHM / FWTM 25.0° / 43.0° Efficiency 86 % Peak intensity 4.1 cd/lm LEDs/each optic 1 Light colour White Required components: F17439_HEKLA-G2-J</p>		
<p>CREE → LED</p> <p>LED CXA/B 15xx FWHM / FWTM 24.0° / 45.0° Efficiency 84 % Peak intensity 3.8 cd/lm LEDs/each optic 1 Light colour White Required components: F17436_HEKLA-G2-D</p>		
<p>LEDIM</p> <p>LED LEDIM/C6 FWHM / FWTM 22.0° / 44.0° Efficiency 84 % Peak intensity 4.2 cd/lm LEDs/each optic 9 Light colour White Required components: F17438_HEKLA-G2-I</p>		

OPTICAL RESULTS (MEASURED):

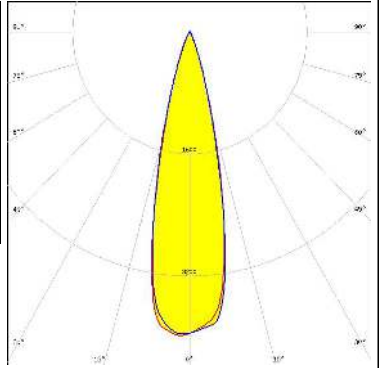
<p>LUMILEDS</p> <p>LED LUXEON CoB 1202/1203</p> <p>FWHM / FWTM 24.0° / 45.0°</p> <p>Efficiency 83 %</p> <p>Peak intensity 3.9 cd/m</p> <p>LEDs/each optic 1</p> <p>Light colour White</p> <p>Required components: F17437_HEKLA-G2-H</p>		
<p>LUMILEDS</p> <p>LED LUXEON CoB 1204HD</p> <p>FWHM / FWTM 23.0° / 45.0°</p> <p>Efficiency 83 %</p> <p>Peak intensity 3.9 cd/m</p> <p>LEDs/each optic 1</p> <p>Light colour White</p> <p>Required components: F17437_HEKLA-G2-H</p>		
<p>LUMILEDS</p> <p>LED LUXEON CoB M02/M03</p> <p>FWHM / FWTM 24.0° / 45.0°</p> <p>Efficiency 84 %</p> <p>Peak intensity 3.9 cd/m</p> <p>LEDs/each optic 1</p> <p>Light colour White</p> <p>Required components: F17436_HEKLA-G2-D</p>		
<p>LUMILEDS</p> <p>LED LUXEON CoB S01</p> <p>FWHM / FWTM 24.0° / 42.0°</p> <p>Efficiency 85 %</p> <p>Peak intensity 4.1 cd/m</p> <p>LEDs/each optic 1</p> <p>Light colour White</p> <p>Required components: F17439_HEKLA-G2-J</p>		

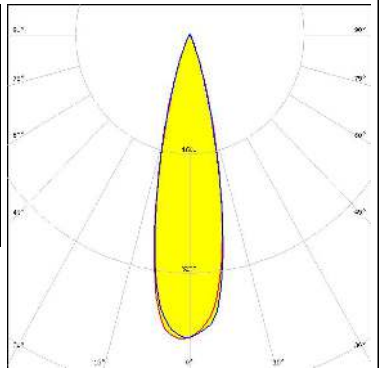
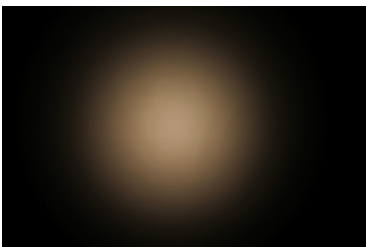
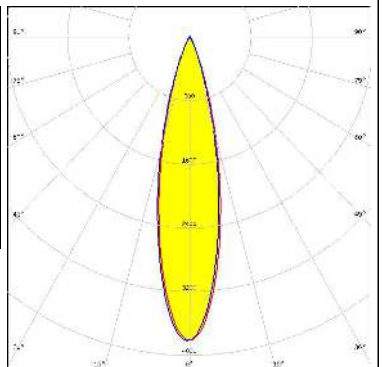
OPTICAL RESULTS (MEASURED):

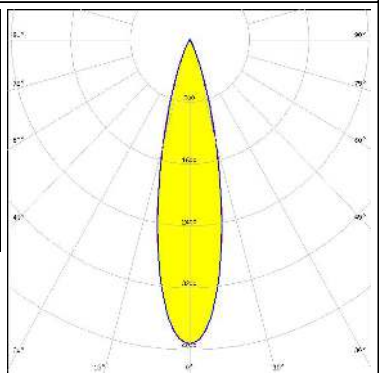
<p>LUMINUS</p> <p>LED CXM-3 FWHM / FWTM 25.0° / 42.0° Efficiency 85 % Peak intensity 4 cd/m LEDs/each optic 1 Light colour White Required components: F17435_HEKLA-G2-C</p>		
<p>LUMINUS</p> <p>LED CXM-4 FWHM / FWTM 24.0° / 42.0° Efficiency 85 % Peak intensity 4.1 cd/m LEDs/each optic 1 Light colour White Required components: F17435_HEKLA-G2-C</p>		
<p>NICHIA</p> <p>LED COB L-Type (LES 9) FWHM / FWTM 24.0° / 45.0° Efficiency 83 % Peak intensity 3.8 cd/m LEDs/each optic 1 Light colour White Required components: F17437_HEKLA-G2-H</p>		
<p>NICHIA</p> <p>LED COB S-Type (LES 7) FWHM / FWTM 24.0° / 44.0° Efficiency 85 % Peak intensity 3.9 cd/m LEDs/each optic 1 Light colour White Required components: F15848_HEKLA-SOCKET-G</p>		

OPTICAL RESULTS (MEASURED):

PHILIPS

LED Fortimo SLM L09 CoB
 FWHM / FWTM 23.0° / 45.0°
 Efficiency 83 %
 Peak intensity 3.9 cd/lm
 LEDs/each optic 1
 Light colour White
 Required components:
 F17437_HEKLA-G2-H

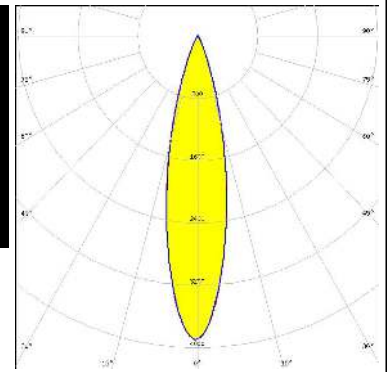

SAMSUNG

LED LC003D / LC006D / LC009D / LC013D
 FWHM / FWTM 24.0° / 46.0°
 Efficiency 84 %
 Peak intensity 3.7 cd/lm
 LEDs/each optic 1
 Light colour White
 Required components:
 F17435_HEKLA-G2-C

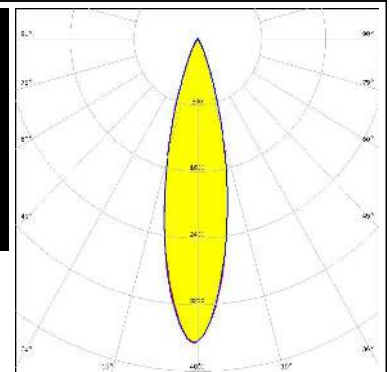
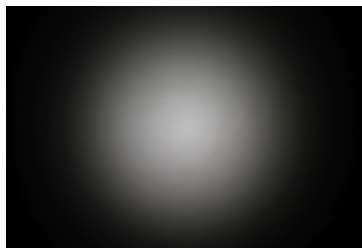

SEOUL SEMICONDUCTOR
 LED MJT COB LES 6
 FWHM / FWTM 24.0° / 43.0°
 Efficiency 85 %
 Peak intensity 4 cd/lm
 LEDs/each optic 1
 Light colour White
 Required components:
 F17435_HEKLA-G2-C

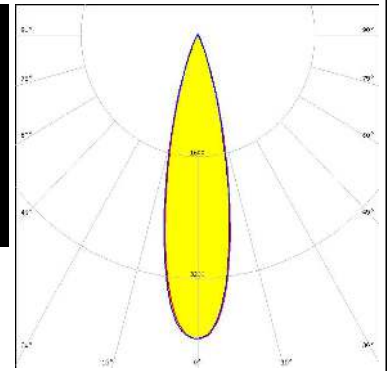
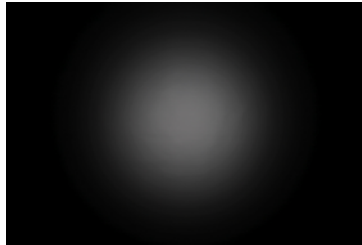

SEOUL SEMICONDUCTOR
 LED MJT COB LES 9.8
 FWHM / FWTM 25.0° / 46.0°
 Efficiency 83 %
 Peak intensity 3.6 cd/lm
 LEDs/each optic 1
 Light colour White
 Required components:
 F17435_HEKLA-G2-C

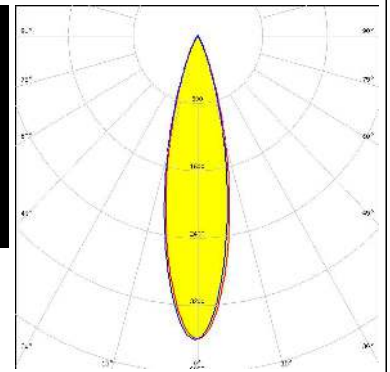
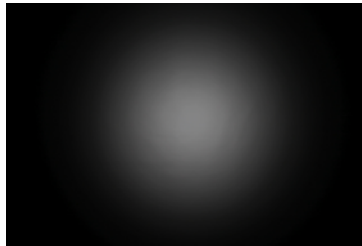



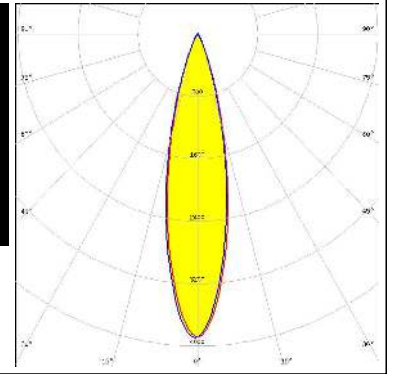

OPTICAL RESULTS (MEASURED):

TRIDONIC

LED SLE G7 LES09
FWHM / FWTM 24.0° / 45.0°
Efficiency 84 %
Peak intensity 3.9 cd/lm
LEDs/each optic 1
Light colour White
Required components:
F17435_HEKLA-G2-C

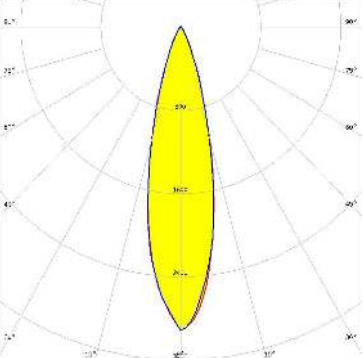

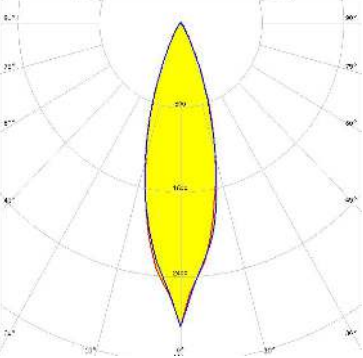
OPTICAL RESULTS (SIMULATED):

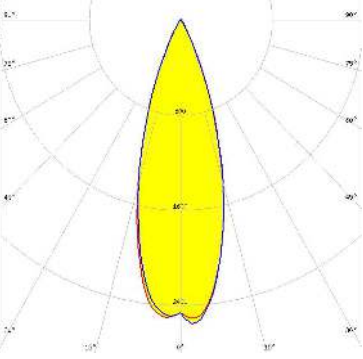
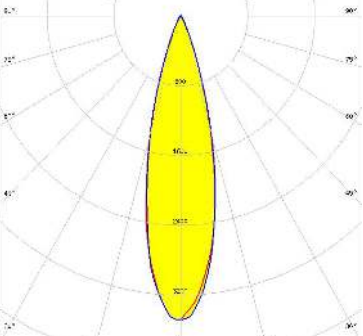
<p></p> <p>LED: Vero SE 13 FWHM / FWTM: 26.0° / 48.0° Efficiency: 73 % Peak intensity: 2.9 cd/lm LEDs/each optic: 1 Light colour: White Required components: C16142_HEKLA-SOCKET-K</p>	
<p></p> <p>LED: Vesta TW 13mm (25W) CSP FWHM / FWTM: 28.0° / 54.0° Efficiency: 83 % Peak intensity: 2.9 cd/lm LEDs/each optic: 1 Light colour: White Required components: C16142_HEKLA-SOCKET-K</p>	
<p></p> <p>LED: Vesta TW 9mm (12W) CSP FWHM / FWTM: 32.0° / 54.0° Efficiency: 85 % Peak intensity: 2.6 cd/lm LEDs/each optic: 1 Light colour: White Required components: C16142_HEKLA-SOCKET-K</p>	
<p>CITIZEN</p> <p>LED: CLU712/713 FWHM / FWTM: 26.0° / 46.0° Efficiency: 83 % Peak intensity: 3.6 cd/lm LEDs/each optic: 1 Light colour: White Required components: F17438_HEKLA-G2-I</p>	

OPTICAL RESULTS (SIMULATED):

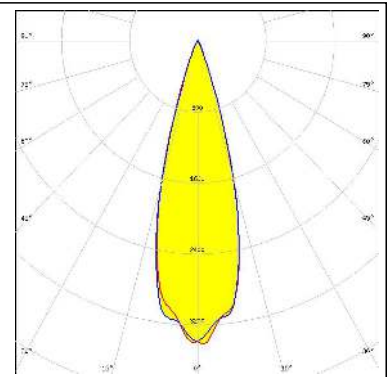
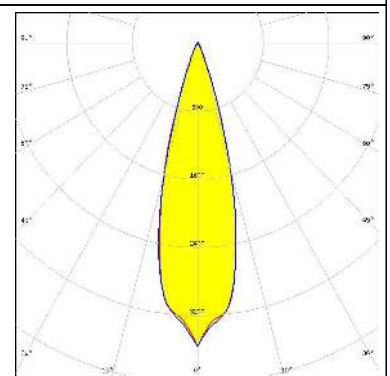
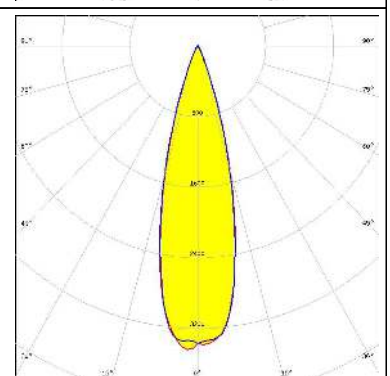
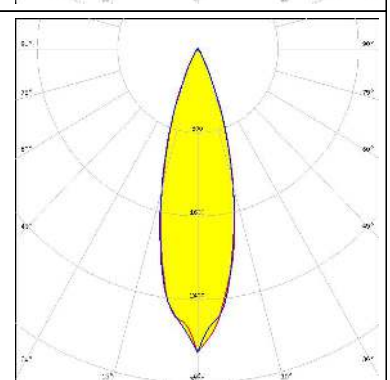
<p>CREE LED</p> <p>LED: CHA0304 FWHM / FWTM: 30.0° / 44.0° Efficiency: 85 % Peak intensity: 3.4 cd/lm LEDs/each optic: 1 Light colour: White Required components: F17435_HEKLA-G2-C</p>	
<p>CREE LED</p> <p>LED: CHA0410 FWHM / FWTM: 28.0° / 44.0° Efficiency: 85 % Peak intensity: 3.6 cd/lm LEDs/each optic: 1 Light colour: White Required components: F17435_HEKLA-G2-C</p>	
<p>CREE LED</p> <p>LED: CHA0612 FWHM / FWTM: 28.0° / 44.0° Efficiency: 84 % Peak intensity: 3.4 cd/lm LEDs/each optic: 1 Light colour: White Required components: F17435_HEKLA-G2-C</p>	
<p>NICHIA</p> <p>LED: NVCWJ024Z-V1MT: COB J-Type Tunable White FWHM / FWTM: 28.0° / 52.0° Efficiency: 83 % Peak intensity: 2.9 cd/lm LEDs/each optic: 1 Light colour: White Required components: C16142_HEKLA-SOCKET-K Bender Wirth: 498 Typ L8 HV</p>	

OPTICAL RESULTS (SIMULATED):

TRIDONIC

LED	SLE G7 LES13
FWHM / FWTM	30.0° / 52.0°
Efficiency	80 %
Peak intensity	2.7 cd/lm
LEDs/each optic	1
Light colour	White
Required components:	
	F17438_HEKLA-G2-I

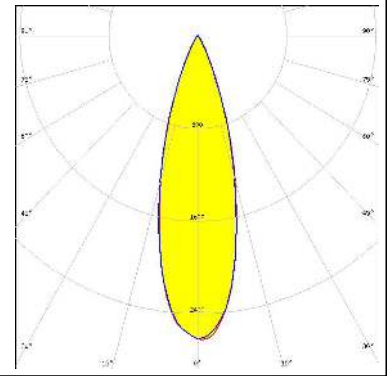

GENERAL INFORMATION:

NOTE: The typical beam angle will be changed by different color, chip size and chip position tolerance. The typical total beam angle is the full angle measured where the luminous intensity is half of the peak value.

Due to use of high power COB's with this product, special attention to proper thermal design is highly recommended. LEDiL has no liability for direct, indirect or consecutive damages arising from the LEDiL products being used outside of the recommended temperature range.

MATERIALS:

As part of our continuous research and improvement processes, and to ensure the best possible quality and availability of our products, LEDiL reserves the right to change material grades without notice.

PRODUCT DATA USER AGREEMENT AND DISCLAIMER:

The measured data in the provided downloadable LEDiL Product Datasheets and Mechanical 2D-Drawings is rounded and provided as reference for planning. LEDiL Oy's optical specifications have been verified by conducting performance testing of the products in accordance with the company's quality system. The reported data are averaged results of multiple measurements with typical variation. LEDiL Oy reserves the right to without prior notification make changes and improvements to its products.

LEDiL Oy assumes neither warranty, nor guarantee nor any other liability of any kind for the contents and correctness of the provided data. The provided data has been generated with highest diligence but the provided data may in reality not represent the complete possible variation range of all intrinsic parameters. Therefore, in certain cases a deviation from the provided data could occur.

LEDiL Oy reserves the right to undertake technical changes of its products without further notification which could lead to changes in the provided data. LEDiL Oy assumes no liability of any kind for the possible deviation from any provided data or any other damage resulting from the usage of the provided data.

The user agrees to this disclaimer and user agreement with the download or usage of the provided files.

LEDiL Oy

Joensuunkatu 13
FI-24240 SALO
Finland

LEDiL Inc.

228 West Page Street
Suite D
Sycamore IL 60178
USA

Ledil Optics Technology (Shenzhen) Co., Ltd.

405 , Block B
Casic Motor Building
Shenzhen 518057
P.R.CHINA

Local sales and technical support

[www.ledil.com/
where_to_buy](http://www.ledil.com/where_to_buy)

Shipping locations

Salo, Finland
Hong Kong, China

Distribution Partners

[www.ledil.com/
where_to_buy](http://www.ledil.com/where_to_buy)