

***RoHS Compliant***

8GB ECC DDR4 SO-DIMM **Halogen free**

***Product Specifications***

**February 18, 2016**

*Version 0.2*



***Apacer Technology Inc.***

1F., No.32, Zhongcheng Rd., Tucheng Dist., New Taipei City 236, Taiwan

Tel: +886-2-2267-8000 Fax: +886-2-2267-2261

[www.apacer.com](http://www.apacer.com)

## Table of Contents

General Description .....	2
Ordering Information .....	2
Key Parameters .....	2
Specifications: .....	3
Features: .....	4
Pin Assignments .....	5
Pin Descriptions .....	7
Functional Block Diagram .....	8
Absolute Maximum Ratings .....	10
DRAM Component Operating Temperature Range .....	11
Operating Conditions .....	12
Mechanical Drawing .....	13

## General Description

Apacer **78.C2GF5.4010B** is a 1024M x 72 DDR4 SDRAM (Synchronous DRAM) SO-DIMM. This high-density memory module consists of 18 pieces 512M x 8 bits with 4 banks DDR4 synchronous DRAMs in FBGA packages and a 4K Bits EEPROM. The module is a 260-pins dual in-line memory module and is intended for mounting into a connector socket. The following provides general specifications of this module.

## Ordering Information

Part Number	Bandwidth	Speed Grade	Max Frequency	CAS Latency
78.C2GF5.4010B	19.2 GB/sec	2400 Mbps	1200 MHz	CL17

Density	Organization	Component	Rank
8GB	1024M x 72	512M x8*18	2

## Key Parameters

MT/s	DDR4-1866	DDR4-2133	DDR4-2400	Unit
Grade	-CL13	-CL15	-CL17	
tCK (min)	1.07	0.93	0.83	ns
CAS latency	13	15	17	tCK
tRCD (min)	13.92	14.06	14.16	ns
tRP (min)	13.92	14.06	14.16	ns
tRAS (min)	34	33	32	ns
tRC (min)	47.92	47.05	46.16	ns
CL-tRCD-tRP	13-13-13	15-15-15	17-17-17	tCK

## Specifications:

- ◆ Support ECC error detection and correction
- ◆ On-DIMM thermal sensor : Yes
- ◆ Organization: 1024 words x 72 bits, 2 ranks
- ◆ Integrating 18 pieces of 4G bits DDR4 SDRAM sealed FBGA
- ◆ Package: 260-pin socket type small outline dual in-line memory module (ECC SO-DIMM)
- ◆ PCB: height 30.00 mm, lead pitch 0.50 mm (pin),
- ◆ Serial Presence Detect (SPD)
- ◆ Power Supply: VDD=1.2V (1.14V to 1.26V)
- ◆ VDDQ = 1.2V (1.14V to 1.26V)
- ◆ VPP = 2.5V (2.375V to 2.75V)
- ◆ VDDSPD = 2.2V to 3.6V
- ◆ 16 internal banks (4 Bank Groups)
- ◆ CAS Latency (CL): 13, 14, 15, 16, 17
- ◆ CAS Write Latency (CWL): 12,16
- ◆ Average refresh period
  - 7.8us at  $0^{\circ}\text{C} \leq \text{TC} \leq 85^{\circ}\text{C}$
  - 3.9us at  $85^{\circ}\text{C} \leq \text{TC} \leq 95^{\circ}\text{C}$
- ◆ Lead-free (RoHS compliant)
- ◆ Halogen free
- ◆ PCB: 30μ gold finger

## Features:

- ◆ Functionality and operations comply with the DDR4 SDRAM datasheet
- ◆ Bank Grouping is applied, and CAS to CAS latency (tCCD\_L, tCCD\_S) for the banks in the same or different bank group accesses are available
- ◆ Bi-Directional Differential Data Strobe
- ◆ 8 bit pre-fetch
- ◆ Burst Length (BL) switch on-the-fly BL8 or BC4(Burst Chop)
- ◆ Supports ECC error correction and detection
- ◆ Per DRAM Addressability is supported
- ◆ Internal Vref DQ level generation is available
- ◆ Write CRC is supported at all speed grades
- ◆ DBI (Data Bus Inversion) is supported(x8)
- ◆ CA parity (Command/Address Parity) mode is supported

## Pin Assignments

Pin No.	Pin name-Front	Pin No.	Pin name-Back	Pin No.	Pin name-Front	Pin No.	Pin name-Back
1	VSS	2	VSS	133	A1	134	EVENT_n
3	DQ5	4	DQ4	135	VDD	136	VDD
5	VSS	6	VSS	137	CK0_t	138	CK1_t
7	DQ1	8	DQ0	139	CK0_c	140	CK1_c
9	VSS	10	VSS	141	VDD	142	VDD
11	DQS0_c	12	DM0_n, DBI0_n	143	PARITY	144	A0
13	DQS0_t	14	VSS	145	BA1	146	A10/AP
15	VSS	16	DQ6	147	VDD	148	VDD
17	DQ7	18	VSS	149	CS0_n	150	BA0
19	VSS	20	DQ2	151	A14/WE_n	152	A16/RAS_n
21	DQ3	22	VSS	153	VDD	154	VDD
23	VSS	24	DQ12	155	ODT0	156	A15/CAS_n
25	DQ13	26	VSS	157	CS1_n	158	A13
27	VSS	28	DQ8	159	VDD	160	VDD
29	DQ9	30	VSS	161	ODT1	162	C0, CS2_n, NC
31	VSS	32	DQS1_c	163	VDD	164	VREFCA
33	DM1_n, DBI1_n	34	DQS1_t	165	C1, CS3_n, NC	166	SA2
35	VSS	36	VSS	167	VSS	168	VSS
37	DQ15	38	DQ14	169	DQ37	170	DQ36
39	VSS	40	VSS	171	VSS	172	VSS
41	DQ10	42	DQ11	173	DQ33	174	DQ32
43	VSS	44	VSS	175	VSS	176	VSS
45	DQ21	46	DQ20	177	DQS4_c	178	DM4_n, DBI4_n
47	VSS	48	VSS	179	DQS4_t	180	VSS
49	DQ17	50	DQ16	181	VSS	182	DQ39
51	VSS	52	VSS	183	DQ38	184	VSS
53	DQS2_c	54	DM2_n, DBI2_n	185	VSS	186	DQ35
55	DQS2_t	56	VSS	187	DQ34	188	VSS
57	VSS	58	DQ22	189	VSS	190	DQ45
59	DQ23	60	VSS	191	DQ44	192	VSS
61	VSS	62	DQ18	193	VSS	194	DQ41
63	DQ19	64	VSS	195	DQ40	196	VSS
65	VSS	66	DQ28	197	VSS	198	DQS5_c
67	DQ29	68	VSS	199	DM5_n, DBI5_n	200	DQS5_t
69	VSS	70	DQ24	201	VSS	202	VSS

Pin No.	Pin name-Front	Pin No.	Pin name-Back	Pin No.	Pin name-Front	Pin No.	Pin name-Back
71	DQ25	72	VSS	203	DQ46	204	DQ47
73	VSS	74	DQS3_c	205	VSS	206	VSS
75	DM3_n, DBI3_n	76	DQS3_t	207	DQ42	208	DQ43
77	VSS	78	VSS	209	VSS	210	VSS
79	DQ30	80	DQ31	211	DQ52	212	DQ53
81	VSS	82	VSS	213	VSS	214	VSS
83	DQ26	84	DQ27	215	DQ49	216	DQ48
85	VSS	86	VSS	217	VSS	218	VSS
87	CB5, NC	88	CB4, NC	219	DQS6_c	220	DM6_n, DBI6_n
89	VSS	90	VSS	221	DQS6_t	222	VSS
91	CB1, NC	92	CB0, NC	223	VSS	224	DQ54
93	VSS	94	VSS	225	DQ55	226	VSS
95	DQS8_c	96	DM8_n, DBI8_n	227	VSS	228	DQ50
97	DQS8_t	98	VSS	229	DQ51	230	VSS
99	VSS	100	CB6, NC	231	VSS	232	DQ60
101	CB2, NC	102	VSS	233	DQ61	234	VSS
103	VSS	104	CB7, NC	235	VSS	236	DQ57
105	CB3, NC	106	VSS	237	DQ56	238	VSS
107	VSS	108	RESET_n	239	VSS	240	DQS7_c
109	CKE0	110	CKE1	241	DM7_n, DBI7_n	242	DQS7_t
111	VDD	112	VDD	243	VSS	244	VSS
113	BG1	114	ACT_n	245	DQ62	246	DQ63
115	BG0	116	ALERT_n	247	VSS	248	VSS
117	VDD	118	VDD	249	DQ58	250	DQ59
119	A12	120	A11	251	VSS	252	VSS
121	A9	122	A7	253	SCL	254	SDA
123	VDD	124	VDD	255	VDDSPD	256	SA0
125	A8	126	A5	257	VPP	258	VTT
127	A6	128	A4	259	VPP	260	SA1
129	VDD	130	VDD	-	-	-	-
131	A3	132	A2	-	-	-	-

\*IC Component Composition :

256Mx8	A0~A13	512Mx4	A0~A14
512Mx8	A0~A14,	1024Mx4	A0~A15
1024Mx8	A0~A15,	2048Mx4	A0~A16
2048Mx8	A0~A16,		

## Pin Descriptions

Pin Name	Description
AX <sup>1*</sup>	SDRAM address bus
BAX	SDRAM bank select
BGX	SDRAM bank group select
RAS <sub>n</sub> <sup>2*</sup>	SDRAM row address strobe
CAS <sub>n</sub> <sup>3*</sup>	SDRAM column address strobe
WE <sub>n</sub> <sup>4*</sup>	SDRAM write enable
CSx <sub>n</sub>	DIMM Rank Select Lines
CKEx	SDRAM clock enable lines
ODTx	SDRAM on-die termination control lines
ACT <sub>n</sub>	SDRAM input for activate input
DQx	DIMM memory data bus
CBx	DIMM ECC check bits
TDQSx <sub>t</sub> ; TDQSx <sub>c</sub>	Dummy loads for mixed populations of x4 based and x8 based RDIMMs. Not used on UDIMMs
DQSx <sub>t</sub>	Data Buffer data strobes (positive line of differential pair)
DQSx <sub>c</sub>	Data Buffer data strobes (negative line of differential pair)
DMx <sub>n</sub> , DBlx <sub>n</sub>	SDRAM data masks/data bus inversion(x8-based x72 DIMMs)
CKx <sub>t</sub>	SDRAM clock input (positive line of differential pair)
CKx <sub>c</sub>	SDRAM clocks input (negative line of differential pair)
SCL	I <sup>2</sup> C serial bus clock for SPD-TSE and register
SDA	I <sup>2</sup> C serial bus data line for SPD-TSE and register
SAX	I <sup>2</sup> C slave address select for SPD-TSE and register
PARITY	SDRAM parity input
VDD	SDRAM core power supply
12 V	Optional Power Supply on socket but not used on DIMM
VREFCA	SDRAM command/address reference supply
VSS	Power supply return (ground)
VDDSPD	Serial SPD-TSE positive power supply
ALERT <sub>n</sub>	SDRAM ALERT <sub>n</sub> output
VPP	SDRAM Supply
RESET <sub>n</sub>	Set Register and SDRAMs to a Known State
EVENT <sub>n</sub>	SPD signals a thermal event has occurred
VTT	SDRAM I/O termination supply
RFU	Reserved for future use

**\*Notes:**

1. Address A17 is only valid for 16 Gb x4 based SDRAMs. For UDIMMs this connection pin is NC.
2. RAS<sub>n</sub> is a multiplexed function with A16.
3. CAS<sub>n</sub> is a multiplexed function with A15.
4. WE<sub>n</sub> is a multiplexed function with A14.



# Functional Block Diagram

## Part 1 of 2

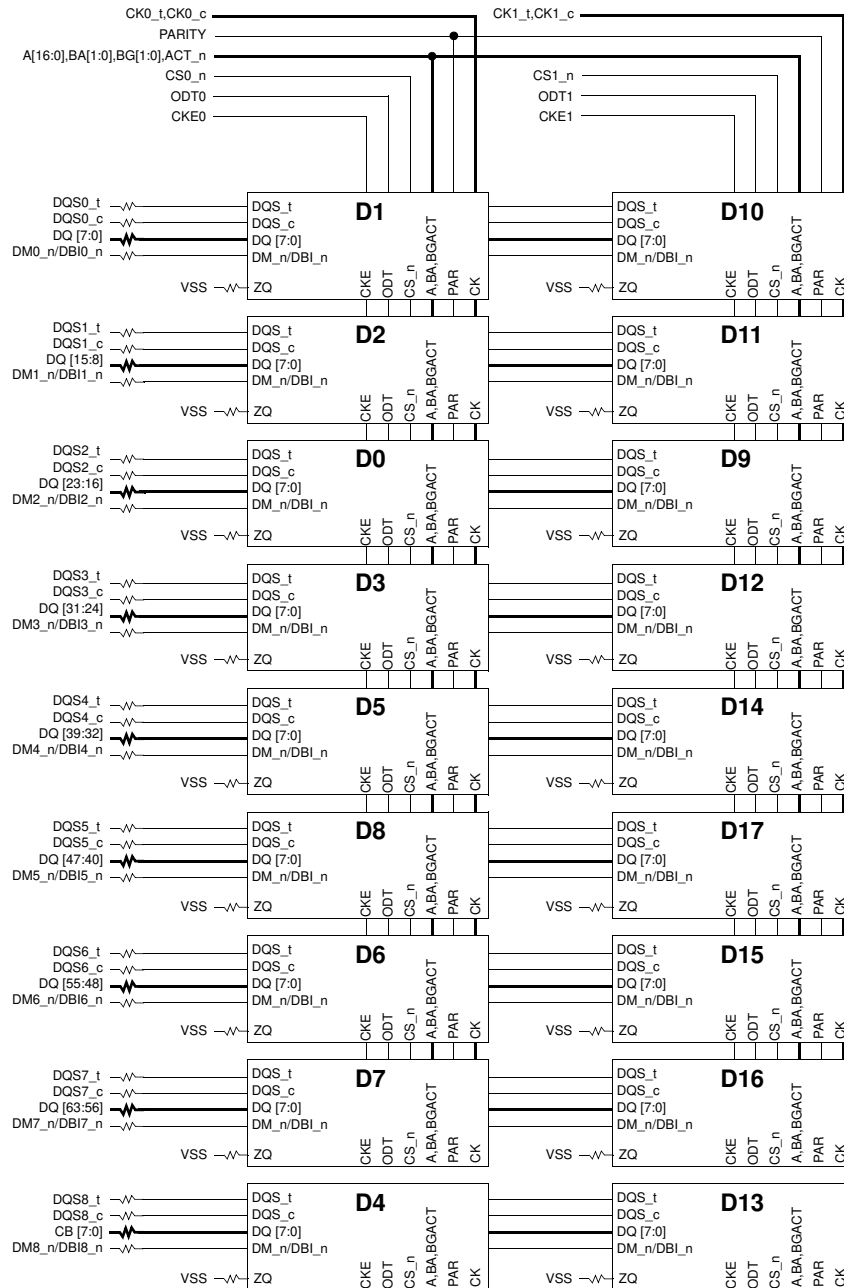

- Note 1:** DQ-to-I/O wiring is shown as recommended but may be changed.
- Note 2:** Unless otherwise noted, resistor values are  $15 \Omega \pm 5\%$ .
- Note 3:** See the Net Structure diagrams for all resistors associated with the command, address and control bus.
- Note 4:** ZQ resistors are  $240 \Omega \pm 1\%$ . For all other resistor values refer to the appropriate wiring diagram.

Part 2 of 2

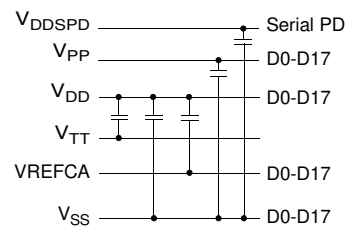
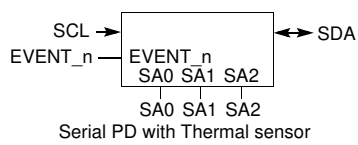
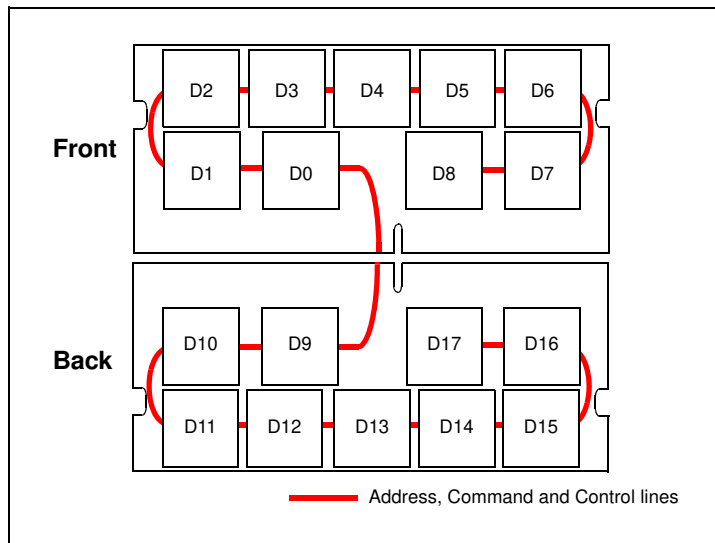

## Absolute Maximum Ratings

Parameter	Symbol	Description	Units	Notes
Voltage on VDD pin relative to Vss	V <sub>DD</sub>	- 0.3 V ~ 1.5 V	V	1,3
Voltage on VDDQ pin relative to Vss	V <sub>DDQ</sub>	- 0.3 V ~ 1.5 V	V	1,3
Voltage on VPP pin relative to Vss	V <sub>PP</sub>	- 0.3 V ~ 3.0 V	V	4
Voltage on any pin relative to Vss	V <sub>IN</sub> , V <sub>OUT</sub>	- 0.3 V ~ 3.0 V	V	1
Storage Temperature	T <sub>STG</sub>	-55 to +100	°C	1,2

Notes:

1. Stresses greater than those listed under "Absolute Maximum Ratings" may cause permanent damage to the device. This is a stress rating only and functional operation of the device at these or any other conditions above those indicated in the operational sections of this specification is not implied. Exposure to absolute maximum rating conditions for extended periods may affect reliability.
2. Storage Temperature is the case surface temperature on the center/top side of the DRAM. For the measurement conditions, please refer to JESD51-2 standard.
3. VDD and VDDQ must be within 300 mV of each other at all times; and VREFCA must be not greater than 0.6 x VDDQ, When VDD and VDDQ are less than 500 mV; VREF may be equal to or less than 300 mV
4. VPP must be equal or greater than VDD/VDDQ at all times

# DRAM Component Operating Temperature Range

Symbol	Parameter	Rating	Units	Notes
T <sub>OPER</sub>	Normal Operating Temperature Range	0 to 85	°C	1,2
	Extended Temperature Range	85 to 95	°C	1,3

Notes:

1. Operating Temperature T<sub>OPER</sub> is the case surface temperature on the center / top side of the DRAM. For measurement conditions please refer to the JEDEC document JESD51-2.
2. The Normal Temperature Range specifies the temperatures where all DRAM specifications will be supported. During operation, the DRAM case temperature must be maintained between 0°C - 85°C under all operating conditions.
3. Some applications require operation of the DRAM in the Extended Temperature Range between 85°C and 95°C case temperature. Full specifications are guaranteed in this range, but the following additional conditions apply:
  - a. Refresh commands must be doubled in frequency, therefore reducing the Refresh interval tREFI to 3.9 μs. It is also possible to specify a component with 1X refresh (tREFI to 7.8μs) in the Extended Temperature Range. Please refer to the DIMM SPD for option availability
  - b. If Self-Refresh operation is required in the Extended Temperature Range, then it is mandatory to either use the Manual Self-Refresh mode with Extended Temperature Range capability (MR2 A6 = 0b and MR2 A7 = 1b), in this case IDD6 current can be increased around 10~20% than normal Temperature range.

# Operating Conditions

## Recommended DC Operating Conditions – DDR4 (1.2V) operation

Symbol	Parameter	Rating			Units	Notes
		Min.	Typ.	Max.		
VDD	Supply Voltage	1.14	1.2	1.26	V	1,2,3
VDDQ	Supply Voltage for Output	1.14	1.2	1.26	V	1,2,3
VPP	Activation Supply Voltage	2.375	2.5	2.75	V	3

Notes:

1. Under all conditions VDDQ must be less than or equal to VDD..
2. VDDQ tracks with VDD. AC parameters are measured with VDD and VDDQ tied together.
3. DC bandwidth is limited to 20MHz.

# Mechanical Drawing

Unit: mm

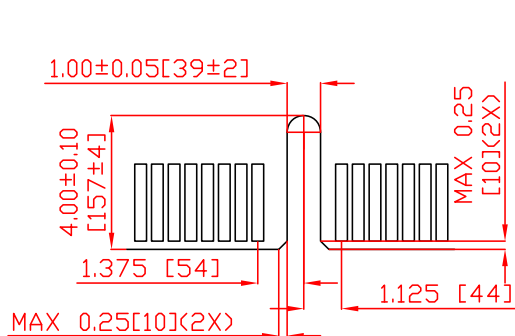
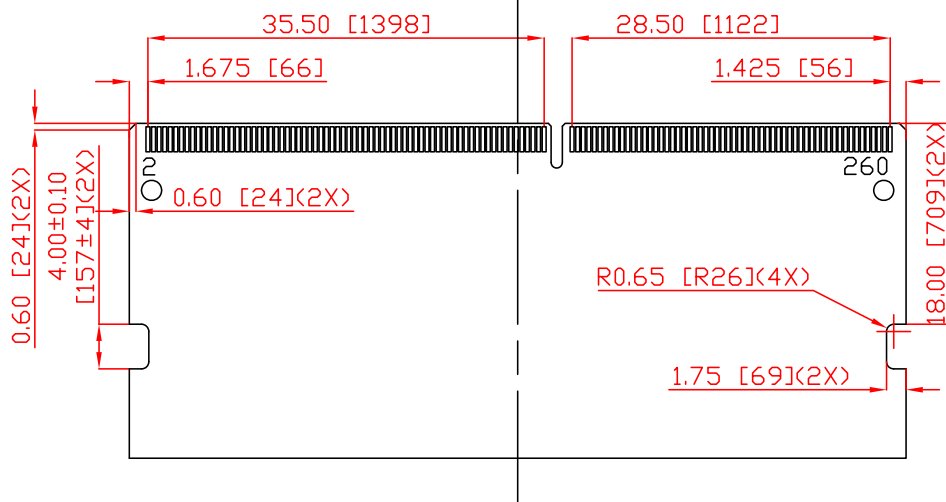
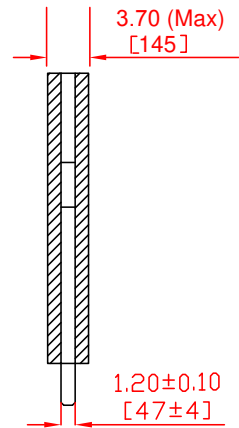
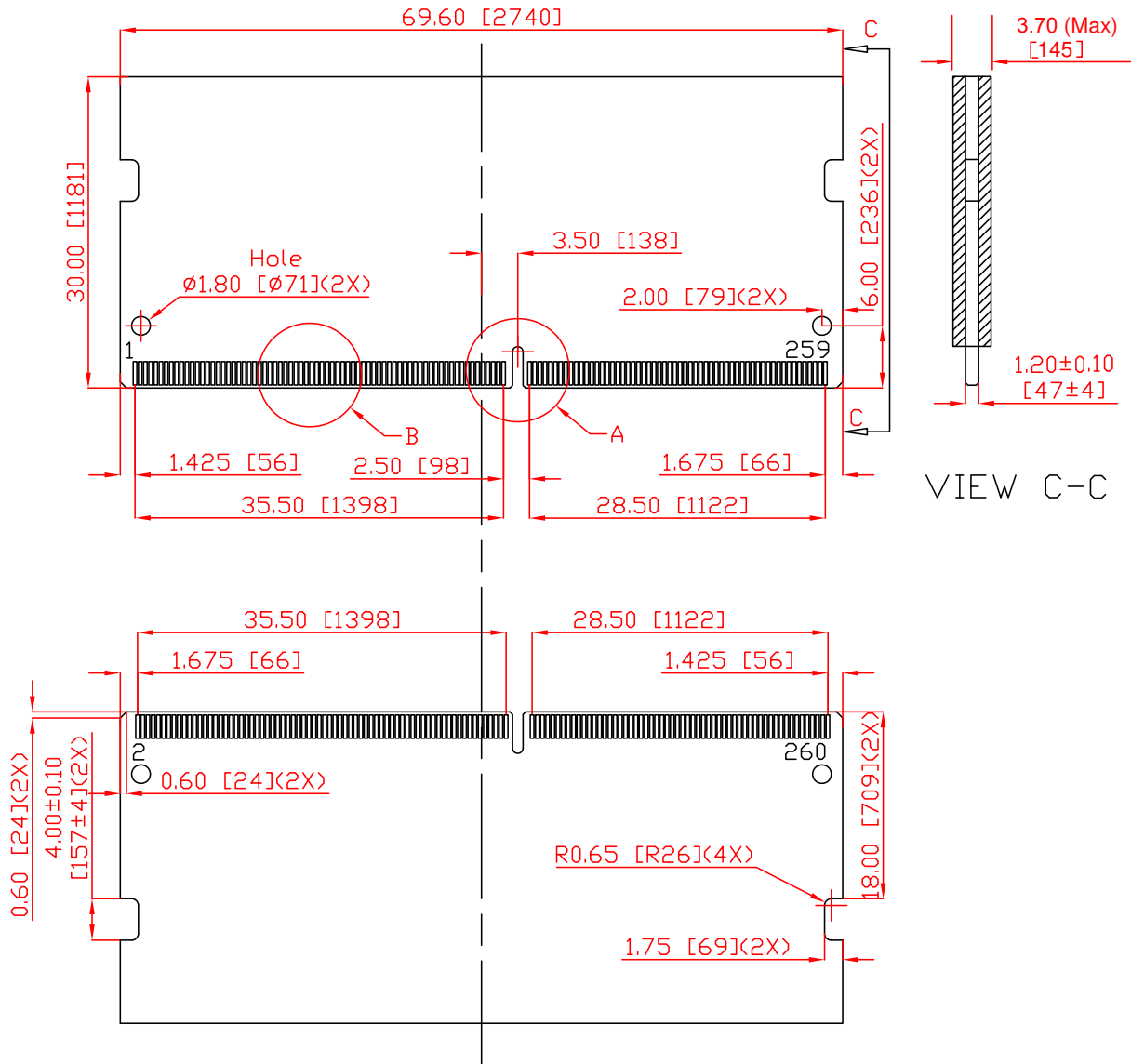

Detail A

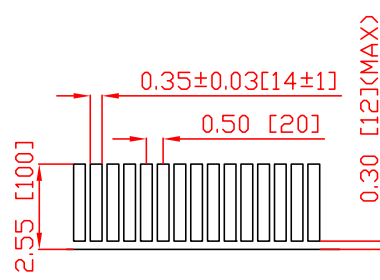

Detail B

30 $\mu$  gold finger

(All dimensions are in millimeters with  $\pm 0.15$ mm tolerance unless specified otherwise.)

## Revision History

<b>Revision</b>	<b>Date</b>	<b>Description</b>	<b>Remark</b>
0.1	5/5/2014	Initial release	
0.2	11/2/2015	Updated VDDSPD	

## Global Presence

### Taiwan (Headquarters)

**Apacer Technology Inc.**

1F., No.32, Zhongcheng Rd., Tucheng Dist.,  
New Taipei City 236, Taiwan R.O.C.

Tel: +886-2-2267-8000

Fax: +886-2-2267-2261

[amtsales@apacer.com](mailto:amtsales@apacer.com)

### U.S.A.

**Apacer Memory America, Inc.**

46732 Lakeview Blvd., Fremont, CA 94538

Tel: 1-408-518-8699

Fax: 1-510-249-9568

[sa@apacerus.com](mailto:sa@apacerus.com)

### Japan

**Apacer Technology Corp.**

5F, Matsura Bldg., Shiba, Minato-Ku

Tokyo, 105-0014, Japan

Tel: 81-3-5419-2668

Fax: 81-3-5419-0018

[jpservices@apacer.com](mailto:jpservices@apacer.com)

### Europe

**Apacer Technology B.V.**

Science Park Eindhoven 5051 5692 EB Son,  
The Netherlands

Tel: 31-40-267-0000

Fax: 31-40-290-0686

[sales@apacer.nl](mailto:sales@apacer.nl)

### China

**Apacer Electronic (Shanghai) Co., Ltd.**

Room D, 22/FL, No.2, Lane 600, Jieyun Plaza,

Tianshan RD, Shanghai, 200051, China

Tel: 86-21-6228-9939

Fax: 86-21-6228-9936

[sales@apacer.com.cn](mailto:sales@apacer.com.cn)

### India

**Apacer Technologies Pvt Ltd.**

Unit No.201, "Brigade Corner", 7th Block Jayanagar,

Yediyur Circle, Bangalore – 560082, India

Tel: 91-80-4152-9061

Fax: 91-80-4170-0215

[sales\\_india@apacer.com](mailto:sales_india@apacer.com)