

THIS COPY IS PROVIDED ON A RESTRICTED BASIS AND IS NOT TO BE USED IN ANY WAY DETRIMENTAL TO THE INTERESTS OF PANDUIT CORP.

Material	High Conductivity Seamless Copper Tube
Plating	Electro-Tin
Wire Size & Type	Stranded Copper Flex Cable; 444.4 kcmil (1100/24) Diesel Locomotive, 400 kcmil Class K & Class M
Wire Strip Length	2-1/4 in.
Stud Size	7/8 in.
UL Listed Wire Connector	Yes, for applications up to 35kv. Consult cable manufacturer for voltage stress relief instructions with applications greater than 2000 volts.
UL Temperature Rating	90° C
C.S.A Certified Wire Connector	Yes
Panduit Color Code on Barrel	BROWN
Panduit Die Index No. on Barrel	P87
Alternate Industry Die Index No. () on Barrel	(20)

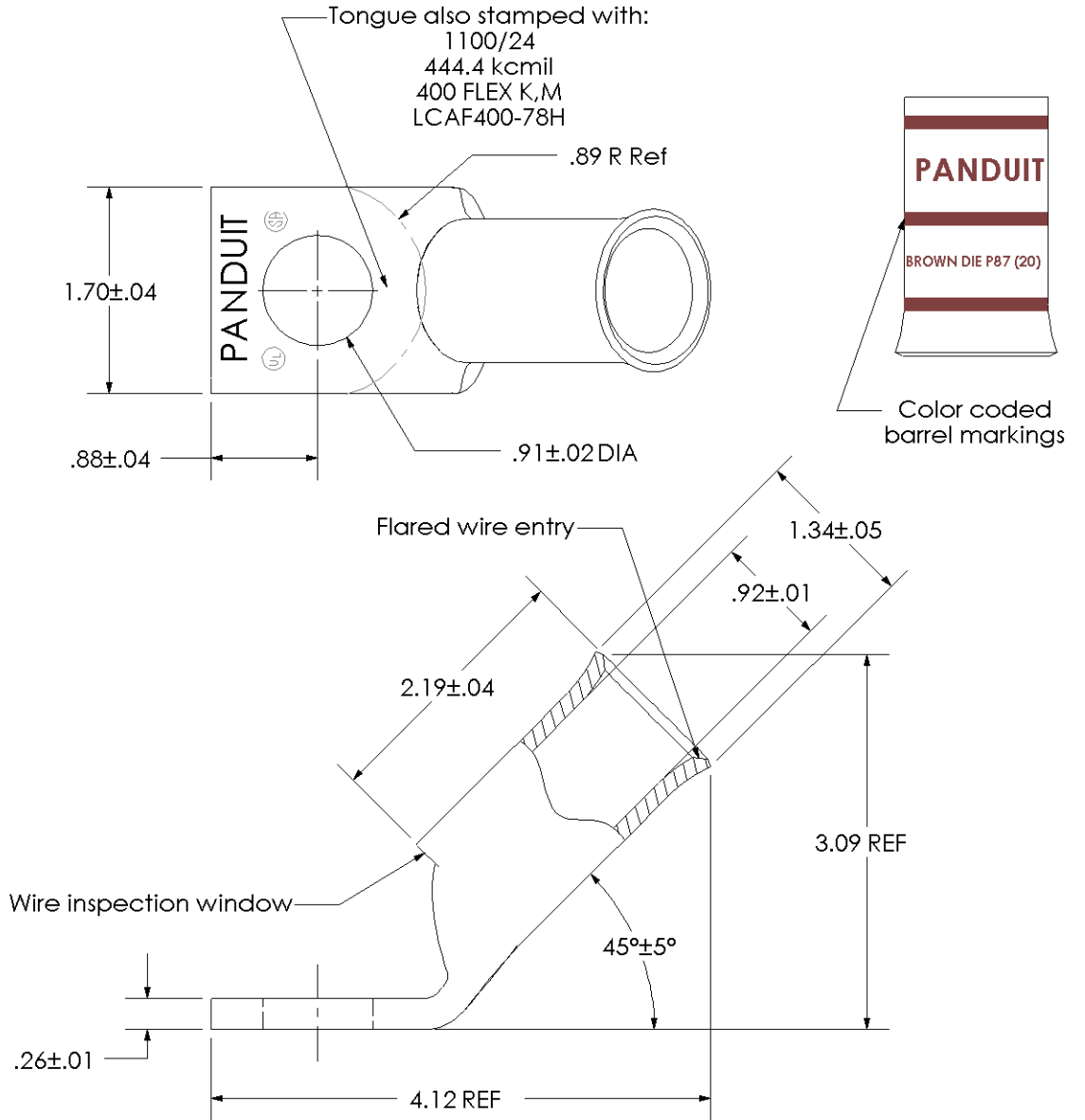

00	8/02	SAB	DRL	RELEASED	10322
REV	DATE	BY	CHK	DESCRIPTION	ECN

PANDUIT CORP. TINLEY PARK, ILLINOIS
 LCAF400-78H-6
 Copper Lug - One-Hole, Flared Barrel, 45° Angle Tongue
 SCALE N/A DRAWING NO / CAD FILE LCAF400-78H-CUST