

IGT40R070D1 E8220

400V CoolGaN™ enhancement-mode Power Transistor

The 400V CoolGaN™ family is the derivative of industry benchmark 600V CoolGaN™ technology, optimized for Class-D Audio amplifier applications.

Features

- Enhancement mode transistor – Normally OFF switch
- Ultra fast switching
- No reverse-recovery charge
- Capable of reverse conduction
- Low gate charge, low output charge
- Superior commutation ruggedness
- Qualified according to JEDEC Standards (JESD47 and JESD22)

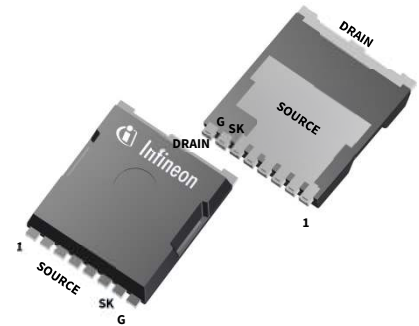

Benefits

- Improves efficiency due to best Figure Of Merit (FOM) in 400V class
- Exhibits very low noise level
- Lower THD compared to best-in-class Silicon switch
- Compatible with existing control ICs

Gate	8
Drain	drain contact
Kelvin Source	7
Source	1,2,3,4,5,6

Applications

- Class-D Audio Amplifier

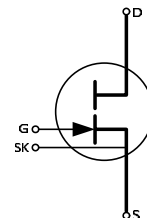

Table 1 Key Performance Parameters at T_j = 25 °C

Parameter	Value	Unit
V _{DS,max}	400	V
R _{DS(on),max}	70	mΩ
Q _{G,typ}	4.5	nC
I _{D,pulse}	60	A
Q _{oss @ 320 V}	35	nC
Q _{rr}	0	nC



Table 2 Ordering Information

Type / Ordering Code	Package	Marking	Related links
IGT40R070D1 E8220	PG-HSOF-8	40L070D1	NA

Table of Contents

Features	1
Benefits	1
Applications	1
Table of Contents	2
1 Maximum ratings	3
2 Thermal characteristics	4
3 Electrical characteristics	5
4 Electrical characteristics diagrams	7
5 Test Circuits	13
6 Package Outlines	14
7 Revision History	15

1 Maximum ratings

at $T_j = 25\text{ °C}$, unless otherwise specified.

Continuous application of maximum ratings can deteriorate transistor lifetime. For further information, contact your local Infineon sales office.

Table 3 Maximum ratings

Parameter	Symbol	Values			Unit	Note/Test Condition
		Min.	Typ.	Max.		
Drain Source Voltage ¹	$V_{DS,max}$	-	-	400	V	$V_{GS} = 0\text{ V}$
Continuous current, drain source	I_D	-	-	31	A	$T_C = 25\text{ °C}; T_j = T_{j,max}$
		-	-	20		$T_C = 100\text{ °C}; T_j = T_{j,max}$
		-	-	14		$T_C = 125\text{ °C}; T_j = T_{j,max}$
Pulsed current, drain source ²³	$I_{D,pulse}$	-	-	60	A	$T_C = 25\text{ °C}; I_G = 26.1\text{ mA}$; See Figure 3; Figure 21;
Pulsed current, drain source ³⁴	$I_{D,pulse}$	-	-	35	A	$T_C = 125\text{ °C}; I_G = 26.1\text{ mA}$; See Figure 4; Figure 22;
Gate current, continuous ⁴⁵	I_G	-	-	20	mA	$T_j = 0\text{ °C to }150\text{ °C}$; Refer to gate drive app note
Gate current, pulsed ⁵	$I_{G,pulse}$	-	-	2000	mA	$T_j = 0\text{ °C to }150\text{ °C}$; $t_{PULSE} = 50\text{ ns}, f = 100\text{ kHz}$ Refer to gate drive app note
Gate source voltage, continuous ⁵	V_{GS}	-10	-	-	V	$T_j = 0\text{ °C to }150\text{ °C}$; Refer to gate drive app note
Gate source voltage, pulsed ⁵	$V_{GS,pulse}$	-25	-	-	V	$T_j = 0\text{ °C to }150\text{ °C}$; $t_{PULSE} = 50\text{ ns}, f = 100\text{ kHz}$; open drain Refer to gate drive app note
Power dissipation	P_{tot}	-	-	125	W	$T_C = 25\text{ °C}$
Operating temperature	T_j	0	-	150	°C	
Storage temperature	T_{stg}	0	-	150	°C	Max shelf life depends on storage conditions.
Drain-source voltage slew-rate	dV/dt			200	V/ns	

¹ All devices are 100% tested at $I_{DS} = 12.2\text{ mA}$ to assure $V_{DS} \geq 800\text{ V}$

² Limits derived from product characterization, parameter not measured during production

³ Ensure that average gate drive current, I_G is $\leq 20\text{ mA}$

⁴ Parameter is influenced by rel-requirements. Please contact the local Infineon Sales Office to get an assessment of your application.

⁵ We recommend using an advanced driving technique to optimize the device performance. Please see application information for details.

2 Thermal characteristics

Table 4 Thermal characteristics

Parameter	Symbol	Values			Unit	Note/Test Condition
		Min.	Typ.	Max.		
Thermal resistance, junction-case	R_{thJC}	-	-	1	°C/W	
Thermal resistance, junction-ambient	R_{thJA}	-	-	62	°C/W	Device on PCB, minimum footprint
Thermal resistance, junction-ambient for SMD version	R_{thJA}	-	35	45	°C/W	Device on 40mm*40mm* 1.5mm epoxy PCB FR4 with 6cm ² (one layer, 70µm thickness) copper area for drain connection and cooling. PCB is vertical without air stream cooling.
Reflow soldering temperature	T_{sold}	-	-	260	°C	MSL1

3 Electrical characteristics

at $T_j = 25\text{ °C}$, unless specified otherwise

Table 5 Static characteristics

Parameter	Symbol	Values			Unit	Note/Test Condition
		Min.	Typ.	Max.		
Gate threshold voltage	$V_{GS(th)}$	0.9 0.7	1.2 1.0	1.6 1.4	V	$I_{DS} = 2.6\text{ mA}; V_{DS} = 10\text{ V}; T_j = 25\text{ °C}$ $I_{DS} = 2.6\text{ mA}; V_{DS} = 10\text{ V}; T_j = 125\text{ °C}$
Drain-Source leakage current	I_{DSS}	- -	1 20	100 -	μA	$V_{DS} = 400\text{ V}; V_{GS} = 0\text{ V}; T_j = 25\text{ °C}$ $V_{DS} = 400\text{ V}; V_{GS} = 0\text{ V}; T_j = 150\text{ °C}$
Drain-Source leakage current at application conditions ¹	I_{DSSapp}	-	60	-	μA	$V_{DS} = 320\text{ V}; V_{GS} = 0\text{ V}; T_j = 125\text{ °C}$
Gate-Source leakage current	I_{GSS}	-1 -1	- -	- -	mA	$V_{DS} = 0\text{ V}; V_{GS} = -10\text{ V}; T_j = 25\text{ °C}$ $V_{DS} = 0\text{ V}; V_{GS} = -10\text{ V}; T_j = 125\text{ °C}$
Drain-Source on-state resistance	$R_{DS(on)}$	- -	0.055 0.100	0.070 -	Ω	$I_G = 26.1\text{ mA}; I_D = 8\text{ A}; T_j = 25\text{ °C}$ $I_G = 26.1\text{ mA}; I_D = 8\text{ A}; T_j = 150\text{ °C}$
Gate resistance	$R_{G,int}$	-	0.68	-	Ω	LCR impedance measurement; $f = f_{res}$; open drain;

Table 6 Dynamic characteristics

Parameter	Symbol	Values			Unit	Note/Test Condition
		Min.	Typ.	Max.		
Input capacitance	C_{iss}	-	382	-	pF	$V_{GS} = 0\text{ V}; V_{DS} = 320\text{ V};$ $f = 1\text{ MHz}$
Output capacitance	C_{oss}	-	72	-	pF	$V_{GS} = 0\text{ V}; V_{DS} = 320\text{ V};$ $f = 1\text{ MHz}$
Reverse Transfer capacitance	C_{rss}	-	0.3	-	pF	$V_{GS} = 0\text{ V}; V_{DS} = 320\text{ V};$ $f = 1\text{ MHz}$
Effective output capacitance, energy related ²	$C_{o(er)}$	-	84	-	pF	$V_{DS} = 0\text{ to }320\text{ V}$
Effective output capacitance, time related ³	$C_{o(tr)}$	-	109.4	-	pF	$V_{GS} = 0\text{ V}; V_{DS} = 0\text{ to }320\text{ V};$ $I_D = \text{const}$
Output charge	Q_{oss}	-	35	-	nC	$V_{DS} = 0\text{ to }320\text{ V}$
Turn- on delay time	$t_{d(on)}$	-	11	-	ns	see Figure 23
Turn- off delay time	$t_{d(off)}$	-	11	-	ns	see Figure 23
Rise time	t_r	-	7.5	-	ns	see Figure 23
Fall time	t_f	-	9	-	ns	see Figure 23

¹ Parameter represents end of use leakage in applications

² $C_{o(er)}$ is a fixed capacitance that gives the same stored energy as C_{oss} while V_{DS} is rising from 0 to 320 V

³ $C_{o(tr)}$ is a fixed capacitance that gives the same charging time as C_{oss} while V_{DS} is rising from 0 to 320 V

Table 7 Gate charge characteristics

Parameter	Symbol	Values			Unit	Note/Test Condition
		Min.	Typ.	Max.		
Gate charge	Q_G	-	4.5	-	nC	$I_{GS} = 0$ to 10 mA; $V_{DS} = 320$ V; $I_D = 8$ A

Table 8 Reverse conduction characteristics

Parameter	Symbol	Values			Unit	Note/Test Condition
		Min.	Typ.	Max.		
Source-Drain reverse voltage	V_{SD}	-	2.0	2.5	V	$V_{GS} = 0$ V; $I_{SD} = 8$ A
Pulsed current, reverse	$I_{S,pulse}$	-	-	60	A	$I_G = 26.1$ mA
Reverse recovery charge	Q_{rr}^1	-	0	-	nC	$I_S = 8$ A, $V_{DS} = 320$ V
Reverse recovery time	t_{rr}	-	0	-	ns	
Peak reverse recovery current	I_{rrm}	-	0	-	A	

¹ Excluding Q_{oss}
 Final Data Sheet

4 Electrical characteristics diagrams

at $T_j = 25\text{ }^\circ\text{C}$, unless specified otherwise

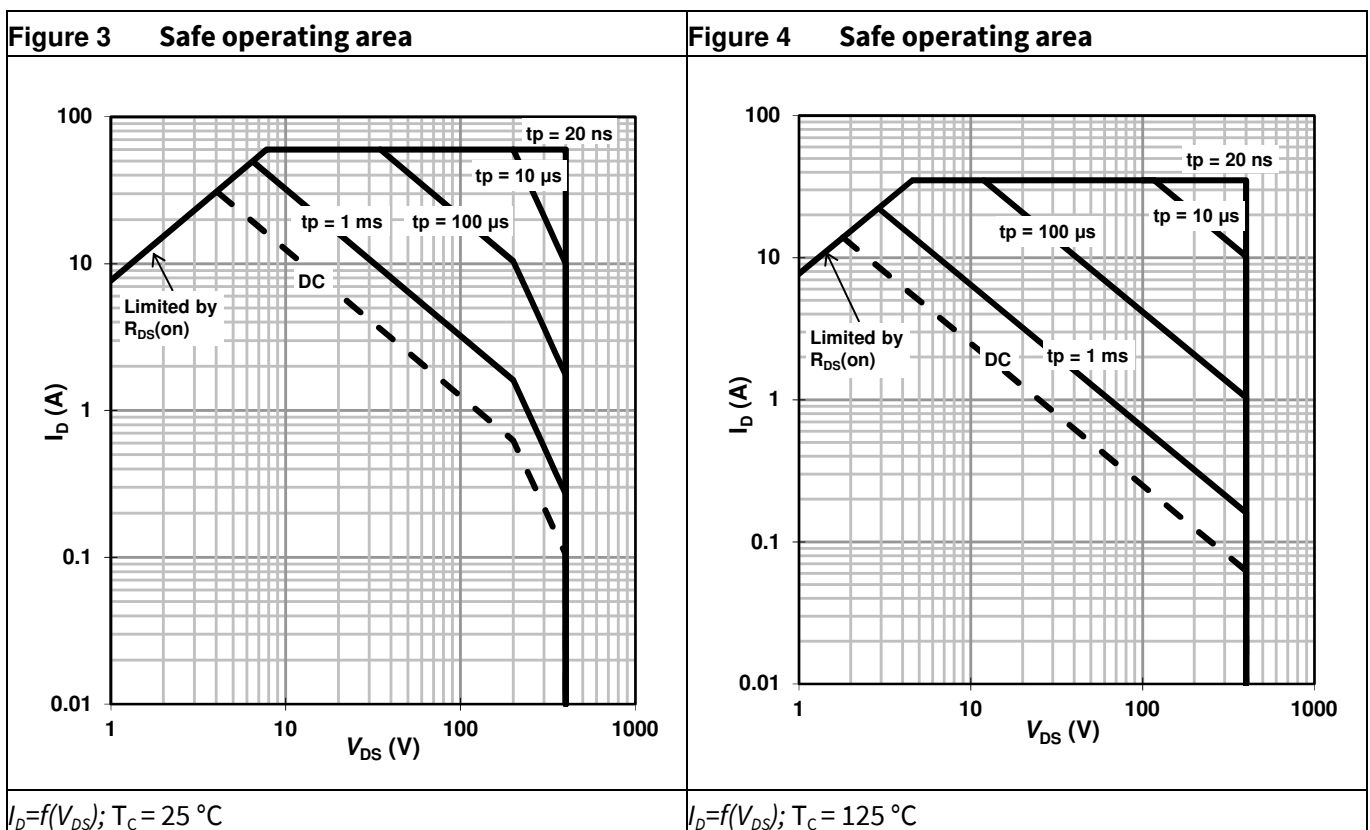
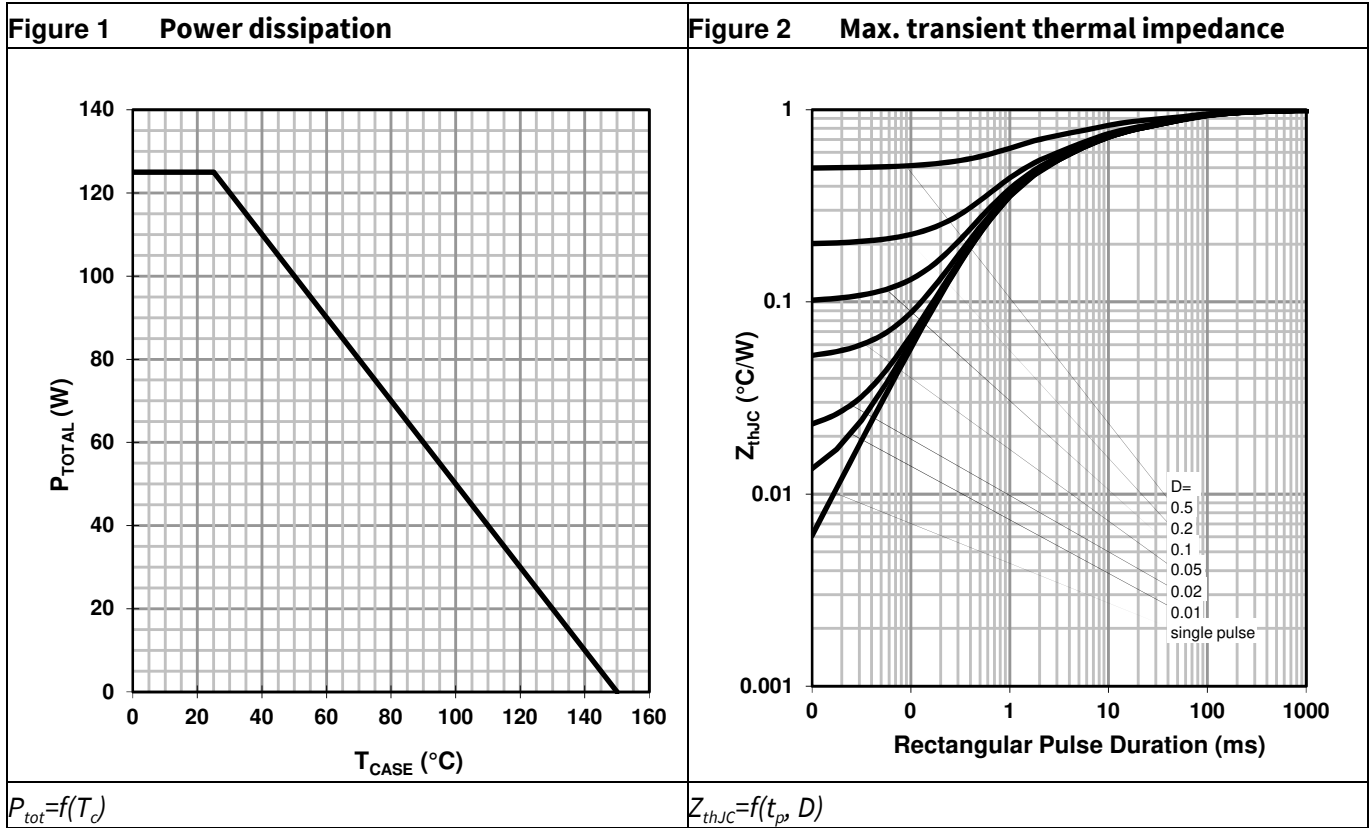

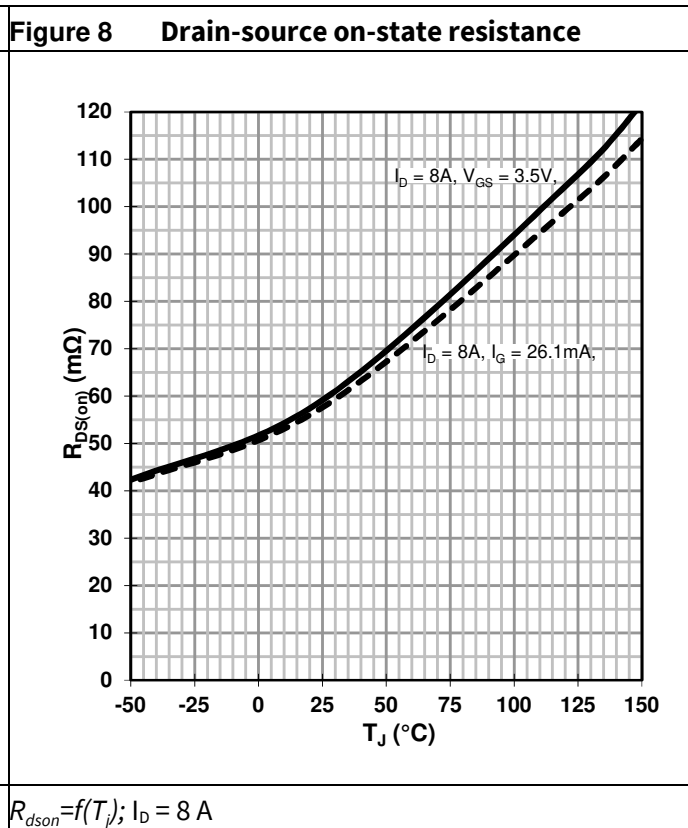
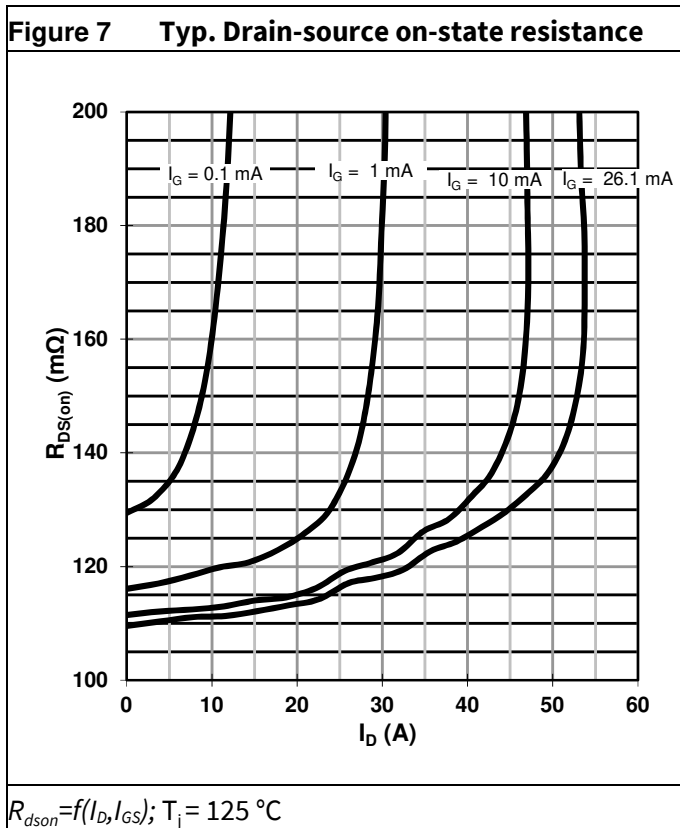
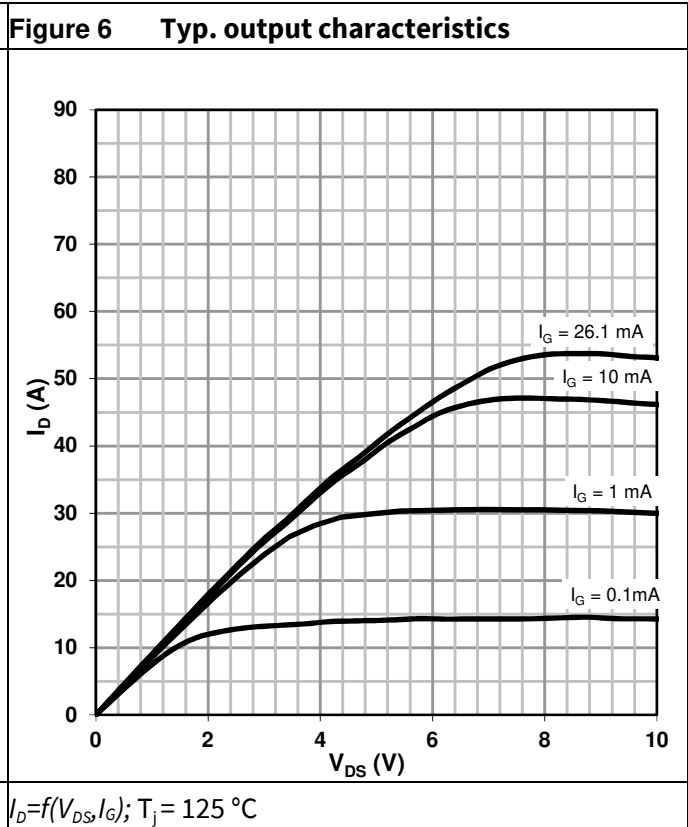
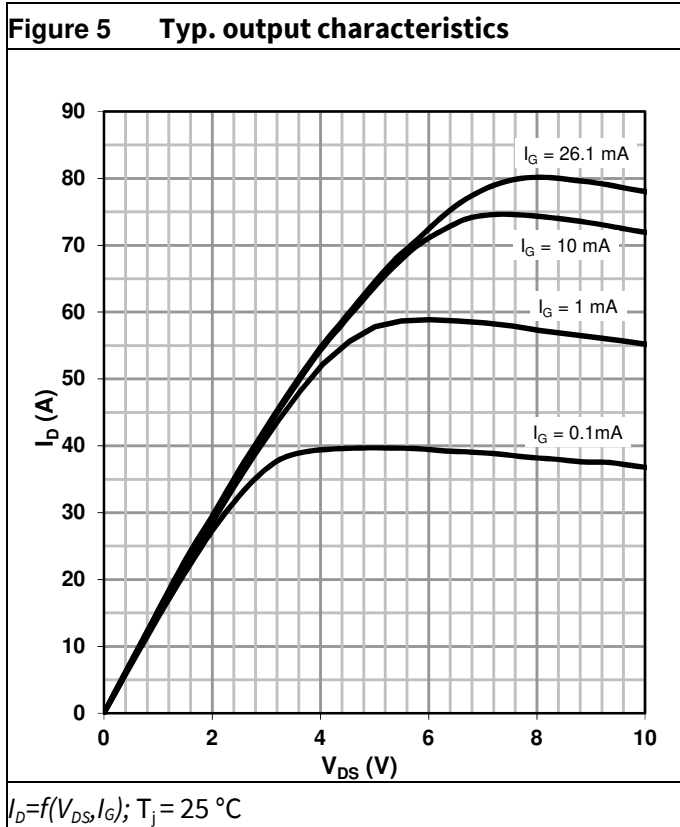
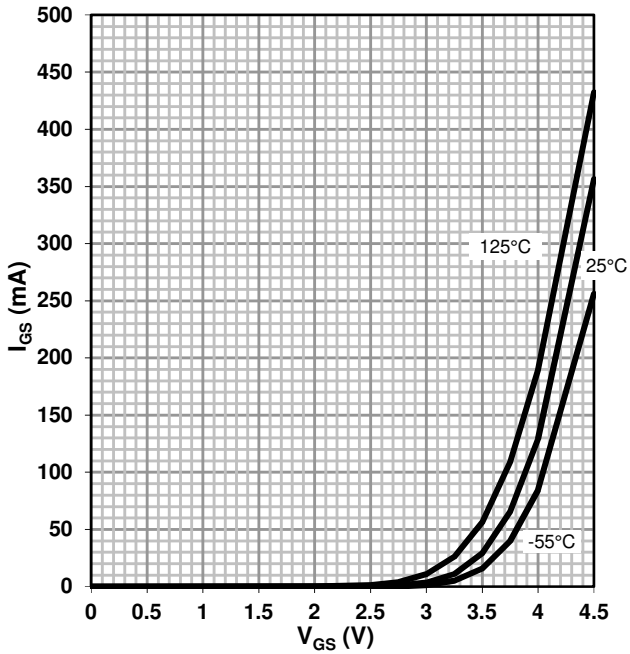
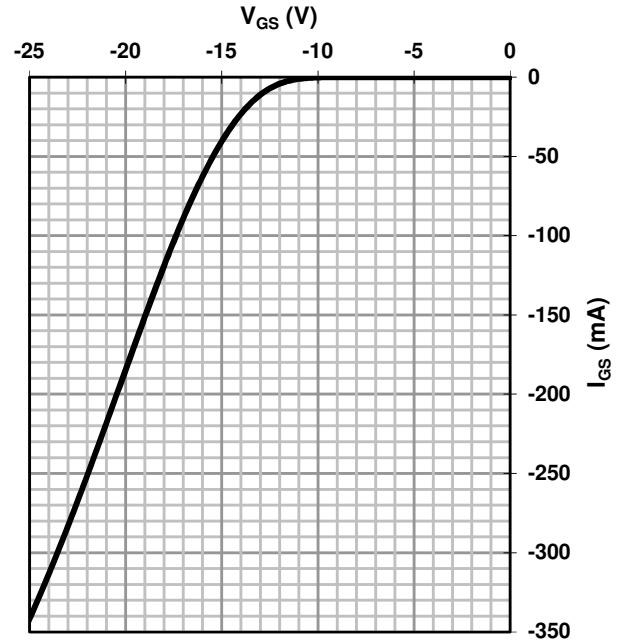

Figure 9 Typ. gate characteristics forward



$I_{GS} = f(V_{GS}, T_j)$; open drain

Figure 10 Typ. gate characteristics reverse



$I_{GS} = f(V_{GS})$; $T_j = 25^\circ\text{C}$

Figure 11 Typ. transfer characteristics

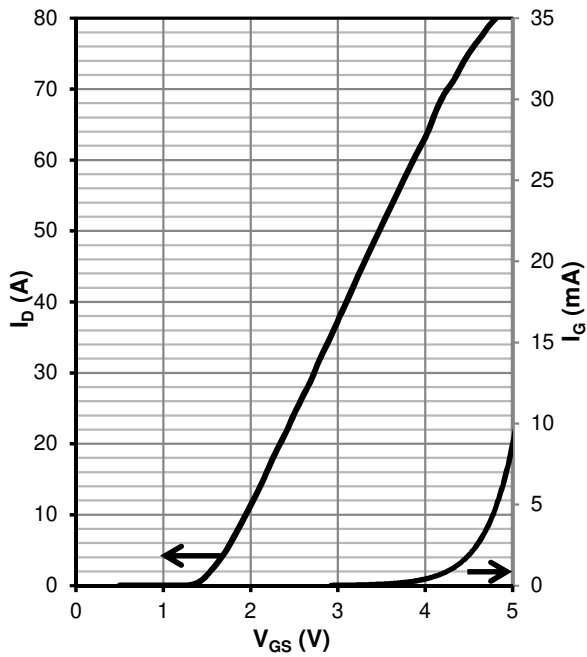

$I_D, I_G = f(V_{GS})$; $V_{DS} = 8\text{ V}$; $T_j = 25^\circ\text{C}$

Figure 12 Typ. transfer characteristics

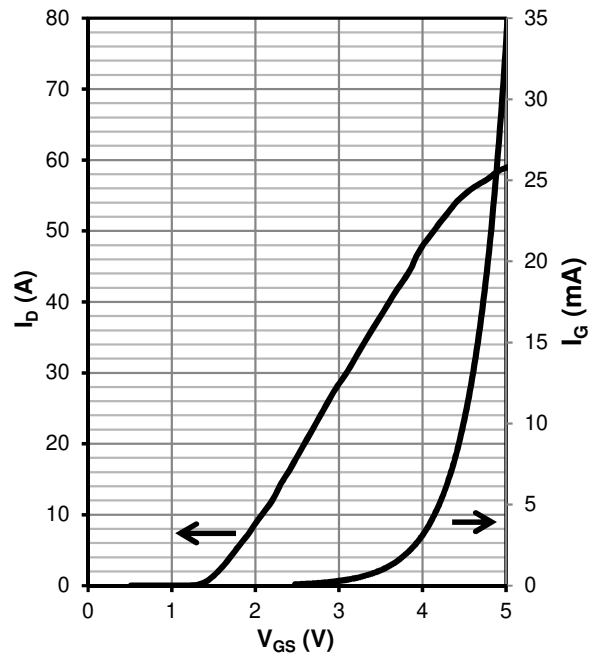

$I_D, I_G = f(V_{GS})$; $V_{DS} = 8\text{ V}$; $T_j = 125^\circ\text{C}$

Figure 13 Typ. channel reverse characteristics

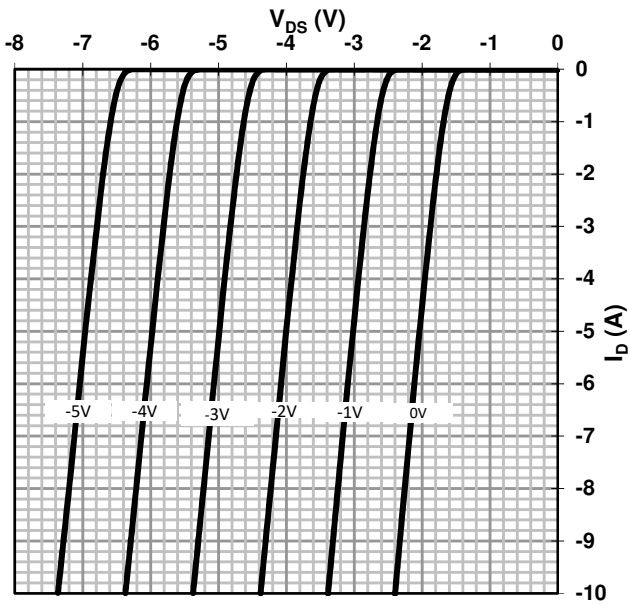

$V_{DS}=f(I_b, V_{GS}); T_j = 25\text{ °C}$

Figure 14 Typ. channel reverse characteristics

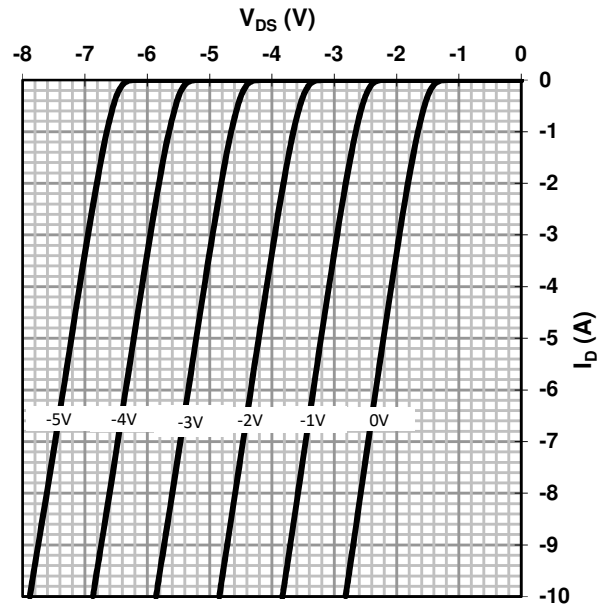

$V_{DS}=f(I_b, V_{GS}); T_j = 125\text{ °C}$

Figure 15 Typ. channel reverse characteristics

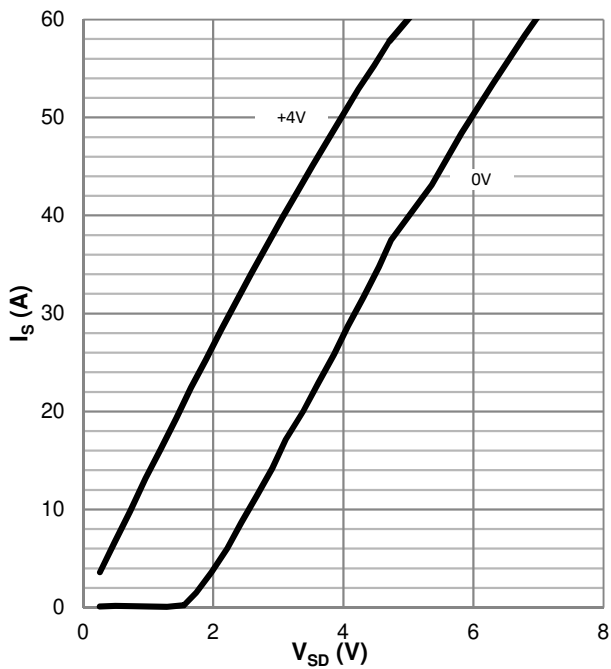

$I_D=f(V_{DS}, V_{GS}); T_j = 25\text{ °C}$

Figure 16 Typ. channel reverse characteristics

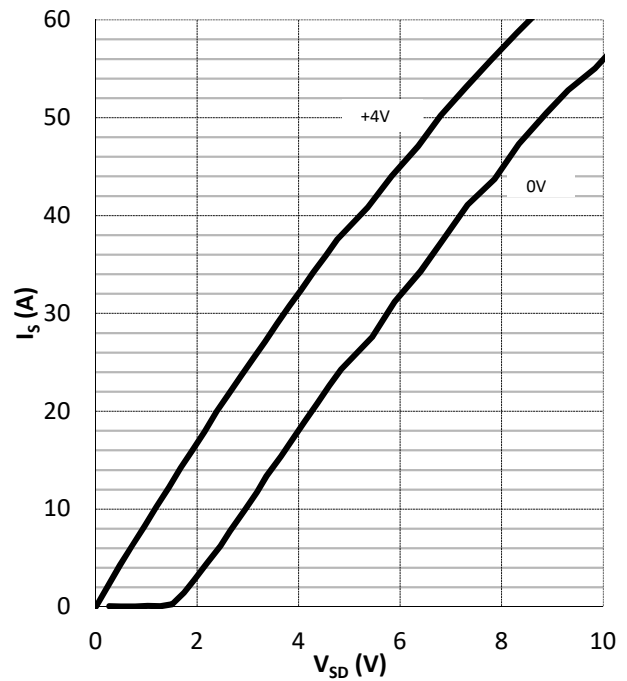

$I_D=f(V_{DS}, V_{GS}); T_j = 125\text{ °C}$

Figure 17 Typ. gate charge

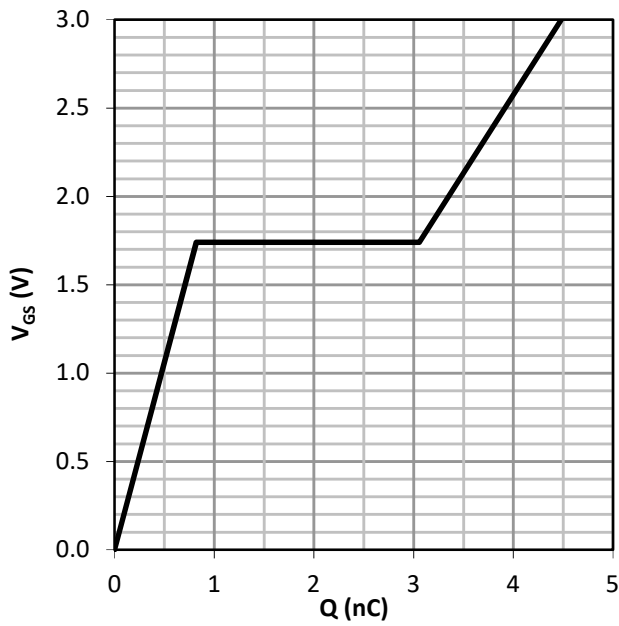

$V_{GS} = f(Q_G); V_{DCLINK} = 320\text{ V}; I_D = 8\text{ A}$

Figure 18 Typ. capacitances

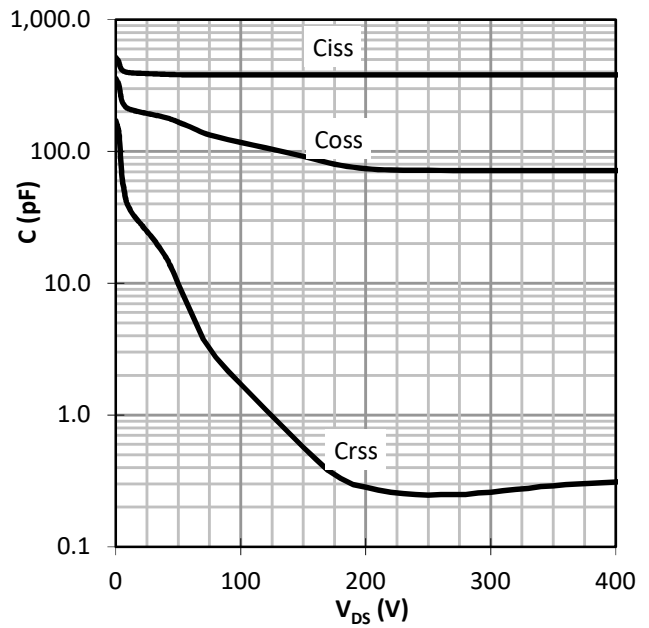

$C_{xSS} = f(V_{DS})$

Figure 19 Typ. output charge

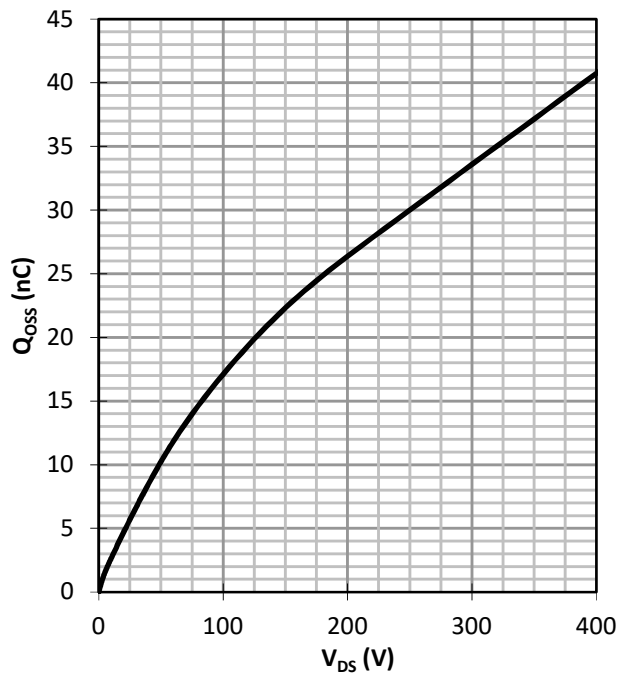

$Q_{oss} = f(V_{DS})$

Figure 20 Typ. Coss stored Energy

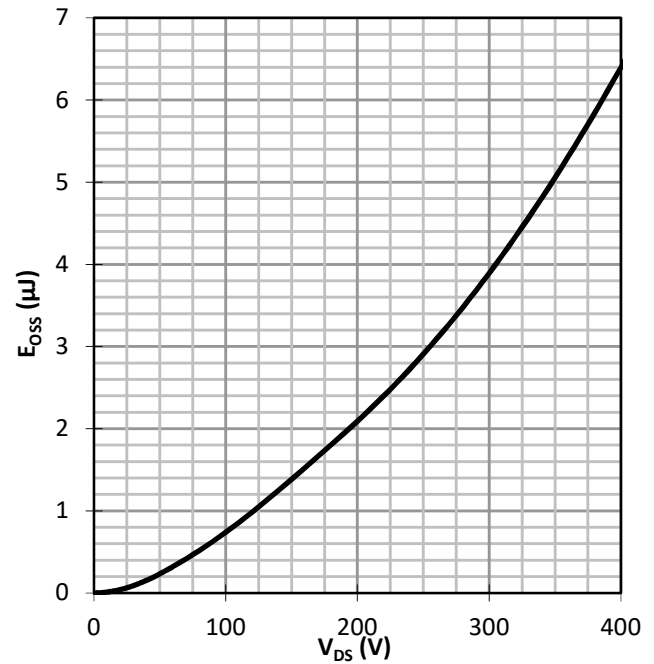

$E_{oss} = f(V_{DS})$

Figure 21 Repetitive safe operating area¹

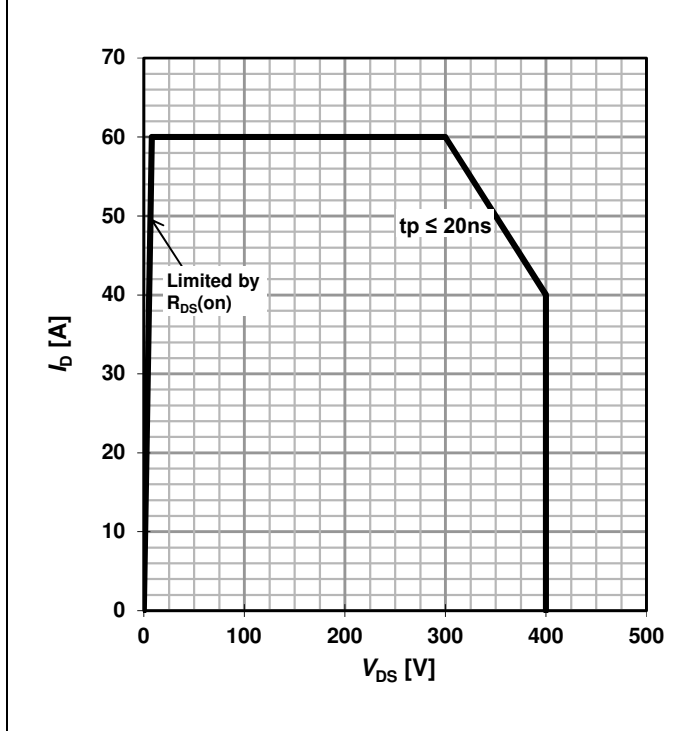

$T_c = 25\text{ °C}; T_j \leq 150\text{ °C}$

Figure 22 Repetitive safe operating area¹

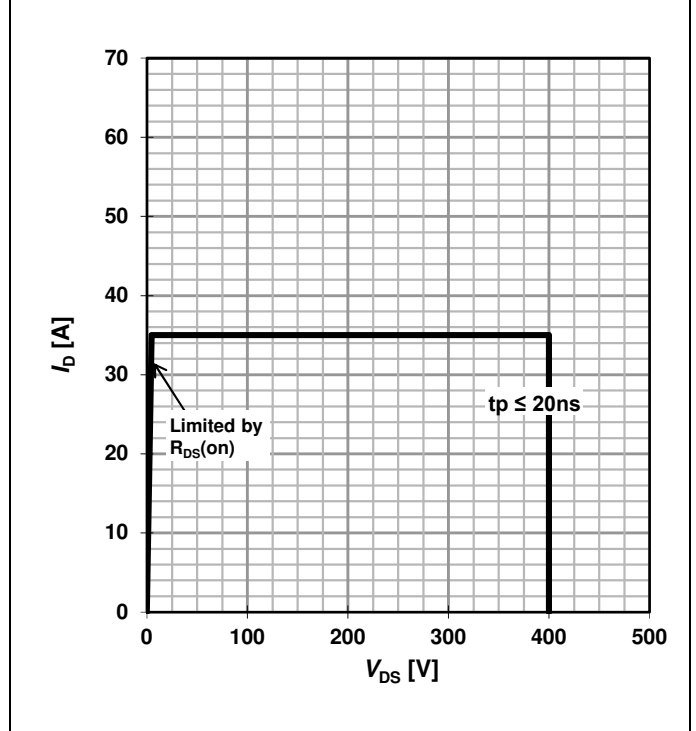

$T_c = 125\text{ °C}; T_j \leq 150\text{ °C}$

¹ Parameter is influenced by rel-requirements. Please contact the local Infineon Sales Office to get an assessment of your application.

5 Test Circuits

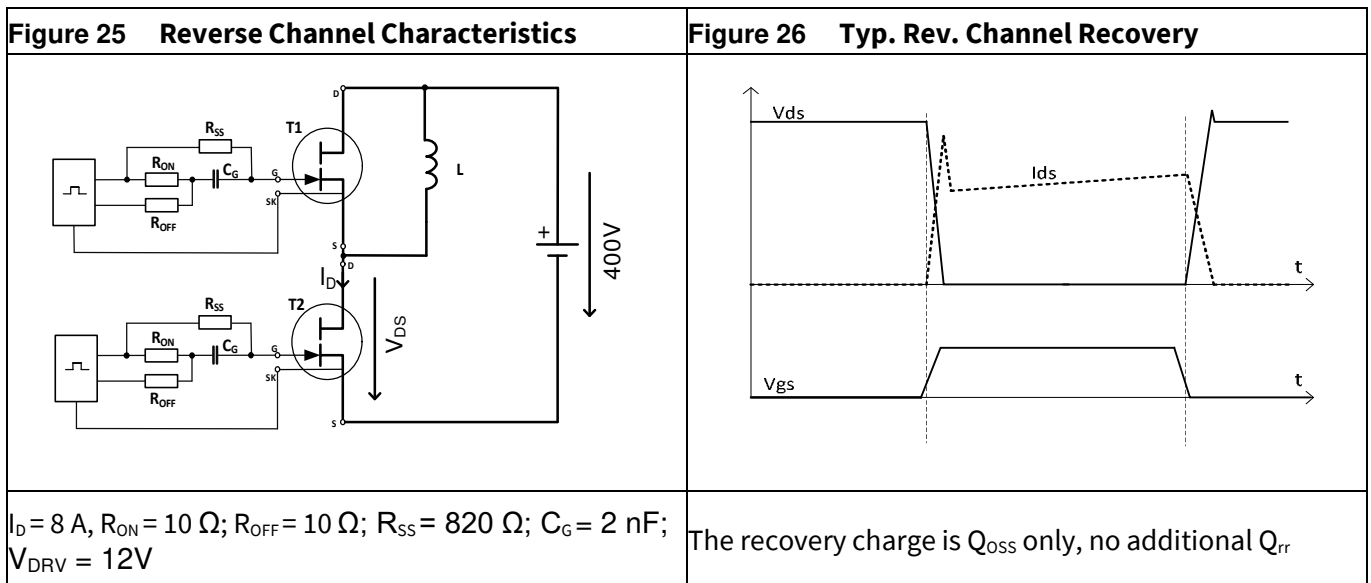
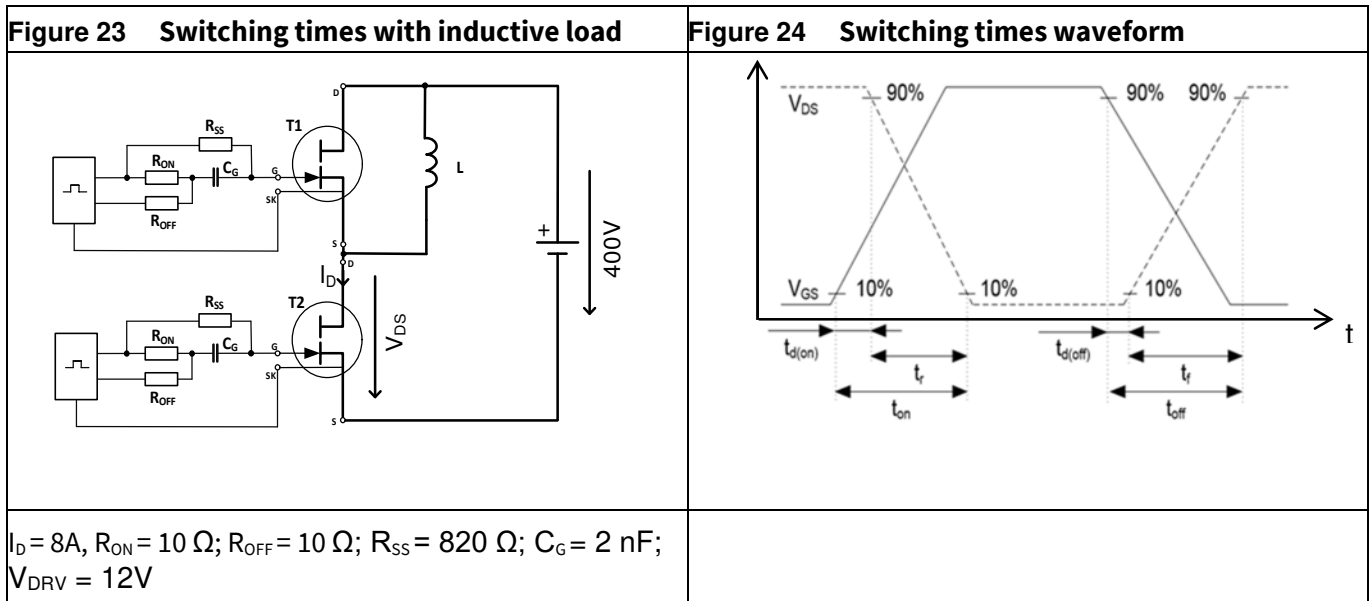

6 Package Outlines

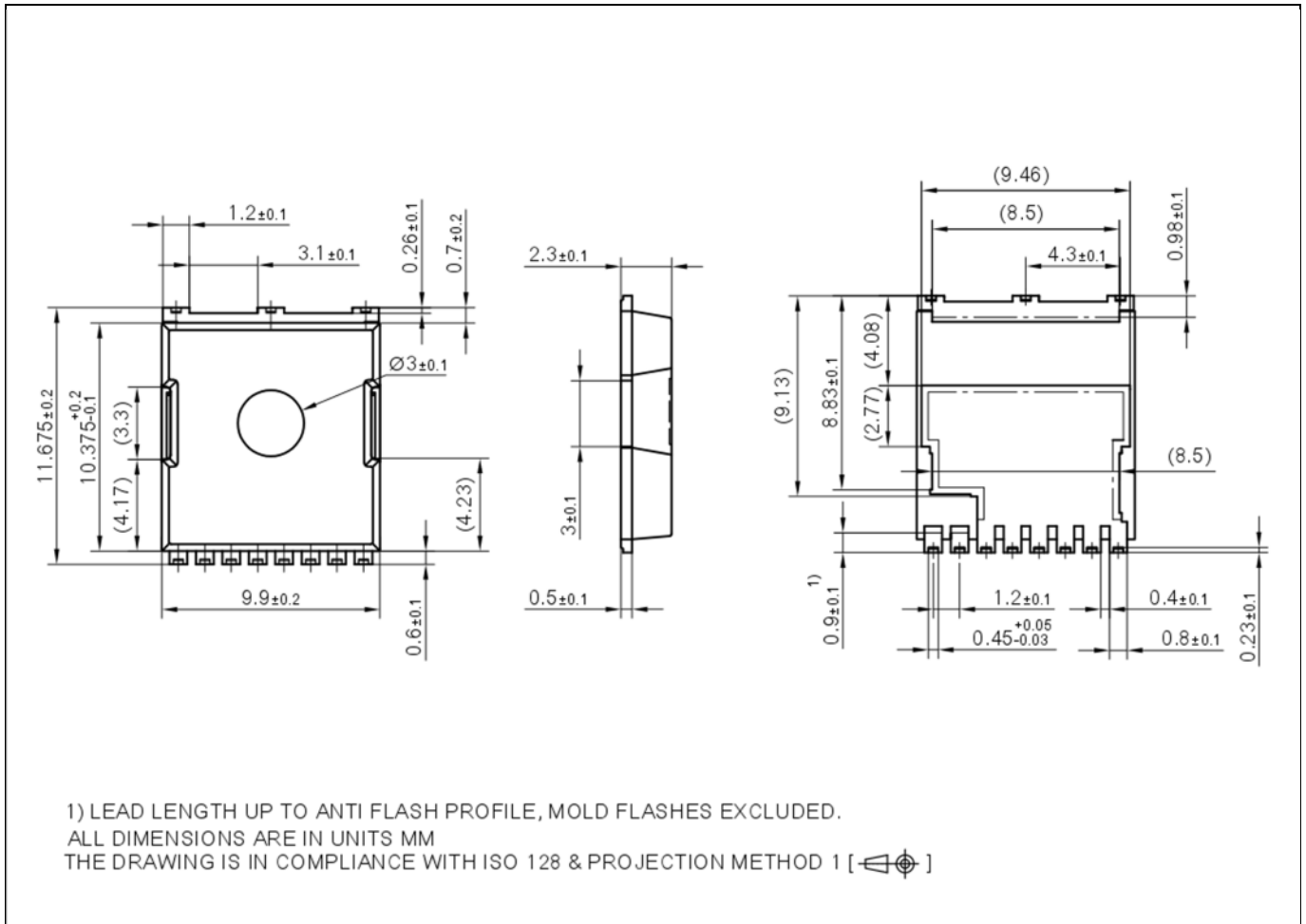

Figure 27 PG-HSOF-8 Package Outline, dimensions (mm)

7 Revision History

Major changes since the last revision

Revision	Date	Description of change
2.0	2018-04-25	Release of final version
2.1	2020-05-29	Updated to MSL1 in table 4

Trademarks of Infineon Technologies AG

μ HVIC™, μ IPM™, μ PFC™, AU-ConvertIR™, AURIX™, C166™, CanPAK™, CIPOS™, CIPURSE™, CoolDP™, CoolGaN™, COOLiR™, CoolMOS™, CoolSET™, CoolSiC™, DAVE™, DI-POL™, DirectFET™, DrBlade™, EasyPIM™, EconoBRIDGE™, EconoDUAL™, EconoPACK™, EconoPIM™, EiceDRIVER™, eupec™, FCOS™, GaNpowIR™, HEXFET™, HITFET™, HybridPACK™, iMOTION™, IRAM™, ISOFACE™, IsoPACK™, LEDrivr™, LITIX™, MIPAQ™, ModSTACK™, my-d™, NovalithIC™, OPTIGA™, OptiMOS™, ORIGA™, PowIRaudio™, PowIRstage™, PrimePACK™, PrimeSTACK™, PROFET™, PRO-SIL™, RASIC™, REAL3™, SmartLEWIS™, SOLID FLASH™, SPOC™, StrongIRFET™, SupIRBuck™, TEMPFET™, TRENCHSTOP™, TriCore™, UHVIC™, XHP™, XMC™

Trademarks updated November 2015

Other Trademarks

All referenced product or service names and trademarks are the property of their respective owners.

Edition 2020-05-29

Published by

Infineon Technologies AG
81726 München, Germany

© 2020 Infineon Technologies AG.
All Rights Reserved.

Do you have a question about this document?

Email: erratum@infineon.com

Document reference

ifx1

IMPORTANT NOTICE

The information given in this document shall in no event be regarded as a guarantee of conditions or characteristics ("Beschaffenheitsgarantie").

With respect to any examples, hints or any typical values stated herein and/or any information regarding the application of the product, Infineon Technologies hereby disclaims any and all warranties and liabilities of any kind, including without limitation warranties of non-infringement of intellectual property rights of any third party.

In addition, any information given in this document is subject to customer's compliance with its obligations stated in this document and any applicable legal requirements, norms and standards concerning customer's products and any use of the product of Infineon Technologies in customer's applications.

The data contained in this document is exclusively intended for technically trained staff. It is the responsibility of customer's technical departments to evaluate the suitability of the product for the intended application and the completeness of the product information given in this document with respect to such application.

For further information on the product, technology, delivery terms and conditions and prices please contact your nearest Infineon Technologies office (www.infineon.com).

WARNINGS

Due to technical requirements products may contain dangerous substances. For information on the types in question please contact your nearest Infineon Technologies office.

Except as otherwise explicitly approved by Infineon Technologies in a written document signed by authorized representatives of Infineon Technologies, Infineon Technologies' products may not be used in any applications where a failure of the product or any consequences of the use thereof can reasonably be expected to result in personal injury.