

# 627C/628C SERIES



## Power Combo D-Sub Connectors: Vertical

### Features:

- Signal, along with power or coaxial contacts within one connector
- Space saving on the PCB and I/O designs
- Available in various pin out configurations
- Pin and socket contact mating design with P.C. tail and solder cup termination
- Metal shell provides EMI/RFI shielding, plug shell indents provide grounding and additional mating retention
- Mounting options for panel mount or connector mating include through hole, threaded hole and threaded standoffs
- D-shaped connector mating outline provides polarization



### Specifications:

	Power/Coaxial Only	Combination
Insulator Material	Thermoplastic Polyester, UL 94V-0, Color: Black	
Contact Material	Copper Alloy	
Contact Plating	Selective Gold (See Ordering Code) over Nickel for the Mating Area, Tin Plating for Tail Area	
Shell Material and Plating	Steel, Sn or Ni Plated	
Shell Material	Nickel Plated Steel	
Current Rating (Power Contacts)	10 amps, 20 amps, 30 amps, 40 amps	
Current Rating (Signal Contacts)		5 amps
Voltage Rating	125 V	
Contact Resistance (Power Contacts)	1 Milliohms maximum	
Contact Resistance (Signal Contacts)		10 Milliohms maximum
Insulation Resistance	5000 megohms minimum	
Dielectric Withstanding Voltage	1000 V AC rms at Sea Level	
Operating Temperature	-55°C To +125°C	
Mating Cycle	500 For 30 Microinches Gold Plating, 50 For Gold Flash Plating	

### Ordering Code:

627-2W2-220-1N2

SERIES: \_\_\_\_\_  
627: PLUG (PIN)  
628: RECEPTACLE (SOCKET)

LAYOUT: \_\_\_\_\_

	POWER/CO-AX ONLY		COMBINATION			
SIZE 9 CONTACT SHELL	2W2	2WK2	5W1			
SIZE 15 CONTACT SHELL	3W3	3WK3	7W2	11W1		
SIZE 25 CONTACT SHELL	5W5		9W4	13W3	17W2	21W1
SIZE 37 CONTACT SHELL	8W8		13W6	17W5	25W3	27W2 21W4
SIZE 50 CONTACT SHELL			24W7	38W4	43W2	47W1

8W8                      2WK2  
 TOTAL NO. OF POWER OR CO-AX CONTACT    MALE FEMALE COMBINATION  
 TOTAL NO. OF CONTACT

CONTACT PLATING THICKNESS: \_\_\_\_\_  
 2 - GOLD FLASH PLATING  
 6 - 30 MICROINCHES OF GOLD PLATING  
 TAIL TYPE: \_\_\_\_\_  
 22 - SOLDER CUP  
 24 - PC TAIL

#### MOUNTING OPTIONS:

- 1 - THROUGH HOLE
  - 2 - #4-40 UNC THREADED HOLE 2.70
  - 3 - #4-40 UNC THREADED HOLE 7.40 (PC TAIL ONLY)
  - 4 - #4-40 UNC THREADED STANDOFF (PC TAIL ONLY)
  - 5 - #4-40 UNC THREADED HOLE WITH BOARDLOCKS (PC TAIL ONLY)
  - 6 - #4-40 UNC THREADED STANDOFF WITH BOARDLOCKS (PC TAIL ONLY)
- A - M3 THREADED HOLE 2.70  
 B - M3 THREADED HOLE 7.40 (PC TAIL ONLY)  
 C - M3 THREADED STANDOFF (PC TAIL ONLY)  
 D - M3 THREADED HOLE WITH BOARDLOCKS (PC TAIL ONLY)  
 E - M3 THREADED STANDOFF WITH BOARDLOCKS (PC TAIL ONLY)

#### SHELL PLATING:

N - NICKEL  
 T - TIN

#### RATING:

POWER CONTACT                      COAXIAL CONTACT  
 CURRENT RATING:                      IMPEDANCE RATING:  
 1 - 10A                                      5 - 50 OHMS  
 2 - 20A                                      7 - 75 OHMS  
 3 - 30A  
 4 - 40A

### Layout:

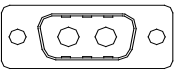
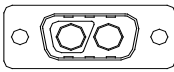
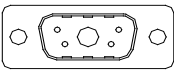
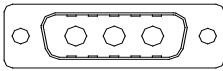
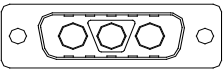
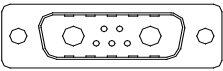
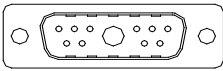
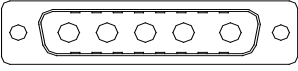
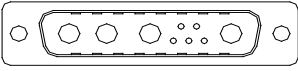
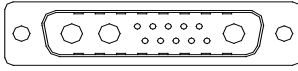
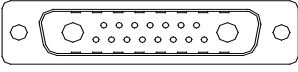
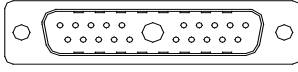
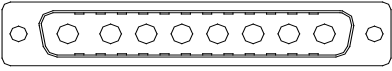
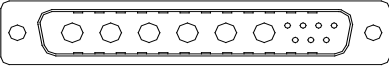
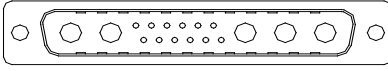
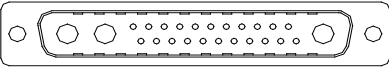
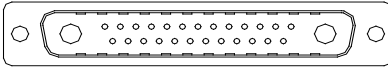
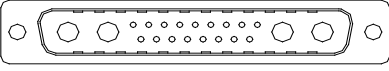
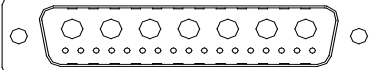
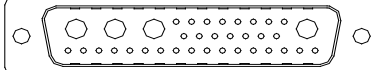
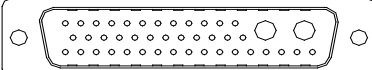
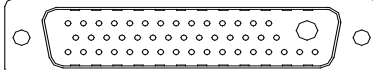
	POWER/COAXIAL D-SUB ONLY	COMBINATION
SIZE 9	 2W2  2WK2	 5W1
SIZE 15	 3W3  3WK3	 7W2  11W1
SIZE 25	 5W5	 9W4  13W3  17W2  21W1
SIZE 37	 8W8	 13W6  17W5  25W3  27W2  21W4
SIZE 50		 24W7  36W4  43W2  47W1

## Power Combo D-Sub Connectors: Vertical

### STRAIGHT PCB TYPE MOUNTING OPTION

CODE:1

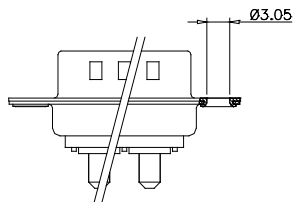

CODE:2/A

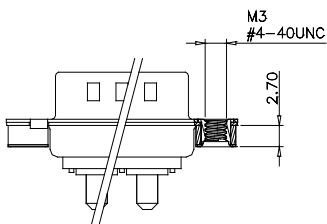

CODE:3/B

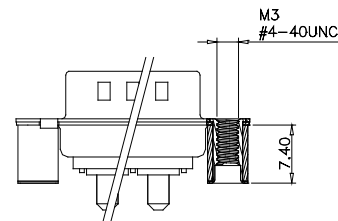

CODE:4/C

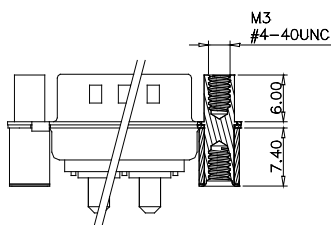

CODE:5/D

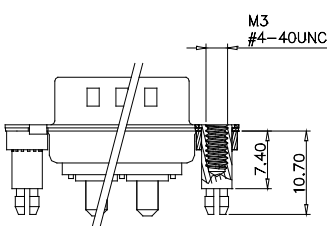

CODE:6/E

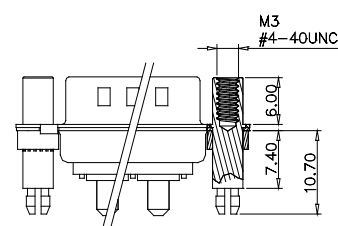

### PCB LAYOUT FOR POWER D-SUB MALE AND FEMALE CONNECTOR

CODE:2W2/2WK2

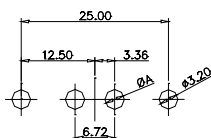

CODE:3W3/3WK3

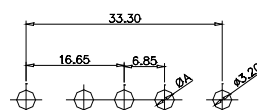

CODE:5W5 MALE

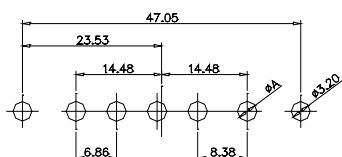

CODE:8W8 MALE

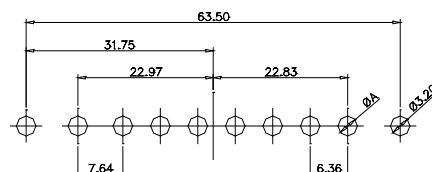

CODE:5W5 FEMALE

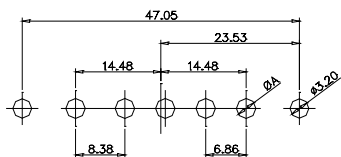

CODE:8W8 FEMALE

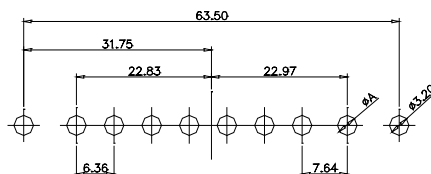

CURRENT RATING	10A	20A	30A	40A
ØA(mm)	2.2	3.3	3.7	4.2

### Power/Coaxial D-SUB

#### STRAIGHT PCB TYPE MOUNTING OPTION

CODE:1

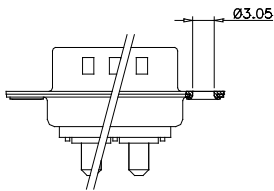

CODE:2/A

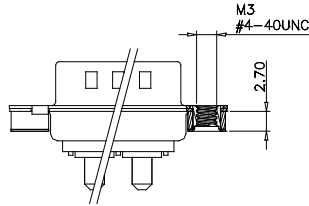

CODE:3/B

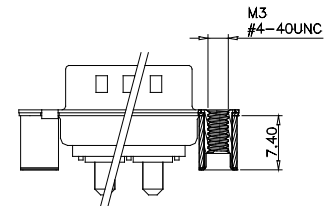

CODE:4/C

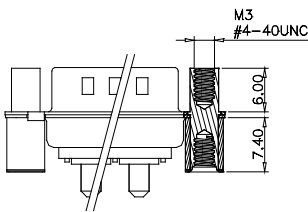

CODE:5/D

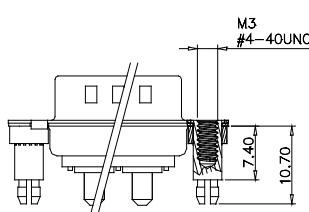

CODE:6/E

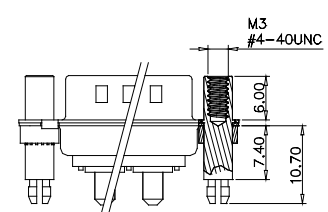

#### PCB LAYOUT FOR POWER D-SUB MALE AND FEMALE CONNECTOR

CODE:2W2/2WK2

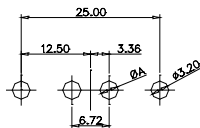

CODE:3W3/3WK3

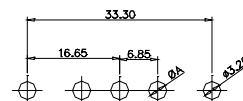

CODE:5W5 MALE

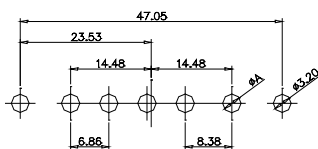

CODE:8W8 MALE

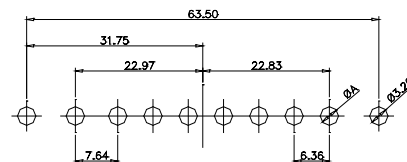

CODE:5W5 FEMALE

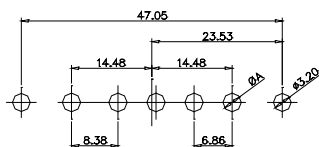

CODE:8W8 FEMALE

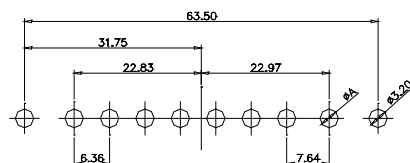

CURRENT RATING	10A	20A	30A	40A
ØA(mm)	2.2	3.3	3.7	4.2

### PCB LAYOUT FOR COAXIAL D-SUB MALE AND FEMALE CONNECTOR

CODE:2W2/2WK2

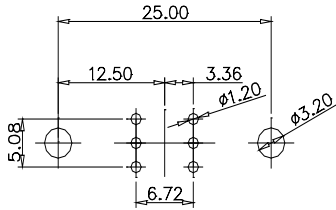

CODE:3W3/3WK3

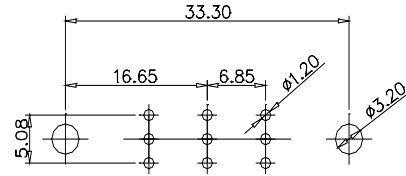

CODE:5W5 MALE

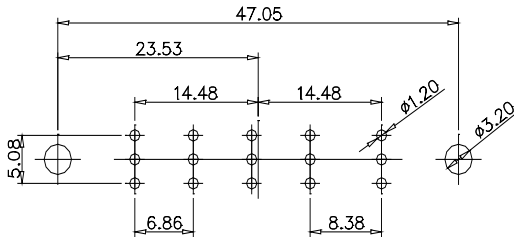

CODE:8W8 MALE

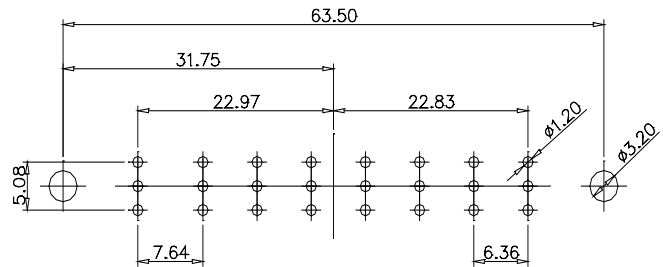

CODE:5W5 FEMALE

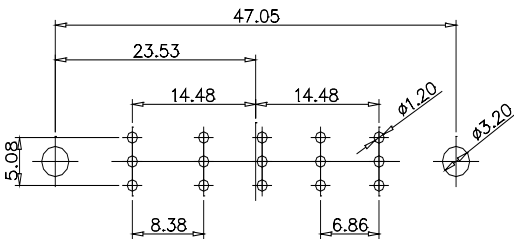

CODE:8W8 FEMALE

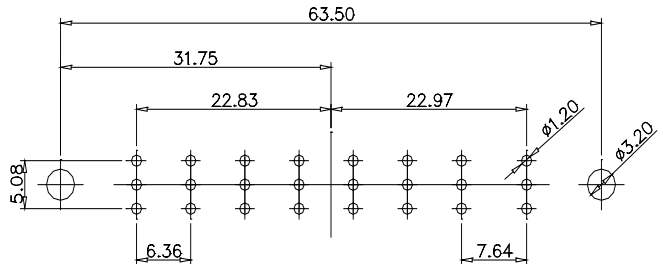

## Power Combo D-Sub Connectors: Vertical

### SOLDER CUP TYPE

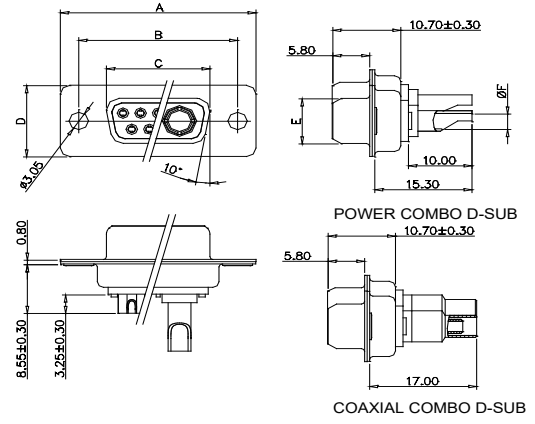
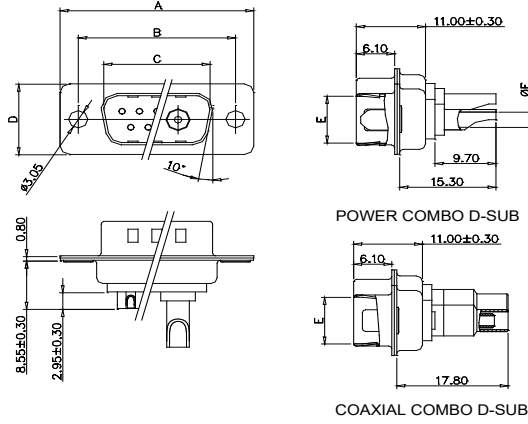

CONTACT SHELL SIZE	POWER D-SUB						
	DIMA	DIMB	DIMC	DIMD	DIME	RATING	ØF
SIZE 9	30.80	25.00	16.90	12.50	8.30	10A	1.7
SIZE 15	39.20	33.30	25.25	12.50	8.30	20A	2.7
SIZE 25	53.05	47.05	38.95	12.50	8.30	30A	3.5
SIZE 37	69.40	63.50	55.40	12.50	11.15	40A	4.6
SIZE 50	67.00	61.00	52.80	15.30	11.15		
COAXIAL D-SUB							

CONTACT SHELL SIZE	POWER D-SUB						
	DIMA	DIMB	DIMC	DIMD	DIME	RATING	ØF
SIZE 9	30.80	25.00	16.30	12.50	7.90	10A	1.7
SIZE 15	39.20	33.30	24.60	12.50	7.90	20A	2.7
SIZE 25	53.05	47.05	38.40	12.50	7.90	30A	3.5
SIZE 37	69.40	63.50	54.80	12.50	7.90	40A	4.6
SIZE 50	67.00	61.00	52.20	15.30	10.90		
COAXIAL D-SUB							

### STRAIGHT PCB TYPE

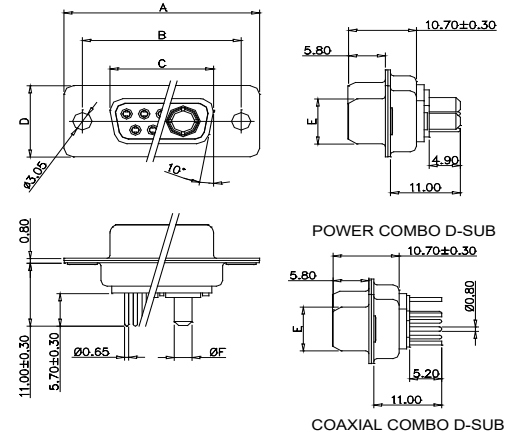
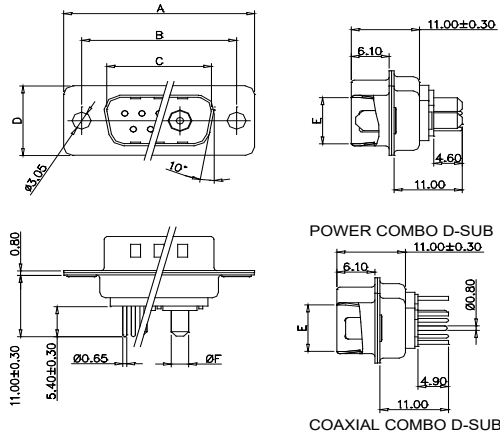

CONTACT SHELL SIZE	POWER D-SUB						
	DIMA	DIMB	DIMC	DIMD	DIME	RATING	ØF
SIZE 9	30.80	25.00	16.90	12.50	8.30	10A	1.7
SIZE 15	39.20	33.30	25.25	12.50	8.30	20A	2.8
SIZE 25	53.05	47.05	38.95	12.50	8.30	30A	3.2
SIZE 37	69.40	63.50	55.40	12.50	11.15	40A	3.75
SIZE 50	67.00	61.00	52.80	15.30	11.15		
COAXIAL D-SUB							

CONTACT SHELL SIZE	POWER D-SUB						
	DIMA	DIMB	DIMC	DIMD	DIME	RATING	ØF
SIZE 9	30.80	25.00	16.30	12.50	7.90	10A	1.7
SIZE 15	39.20	33.30	24.60	12.50	7.90	20A	2.8
SIZE 25	53.05	47.05	38.40	12.50	7.90	30A	3.2
SIZE 37	69.40	63.50	54.80	12.50	7.90	40A	3.75
SIZE 50	67.00	61.00	52.20	15.30	10.90		
COAXIAL D-SUB							

### SOLDER CUP TYPE MOUNTING OPTION

CODE:1

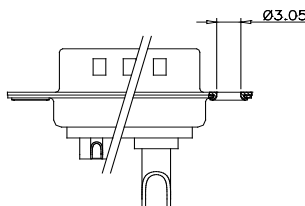

CODE:A

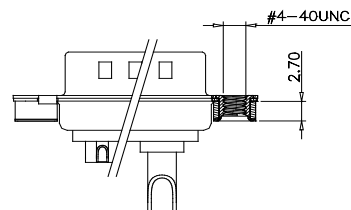

### Power & Coaxial Combo D-SUB

#### STRAIGHT PCB TYPE MOUNTING OPTION

CODE:1

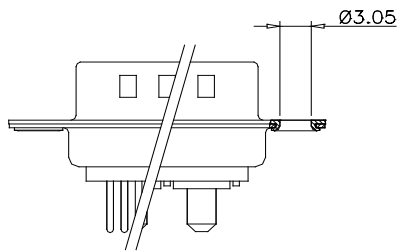

CODE:2/A

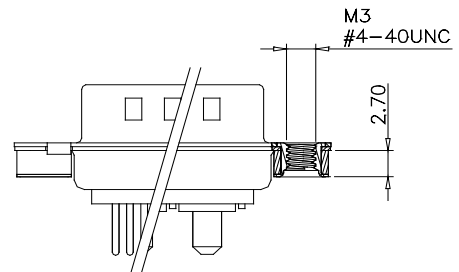

CODE:3/B

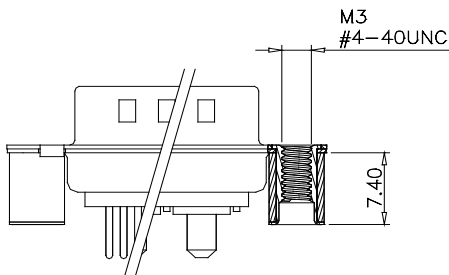

CODE:4/C

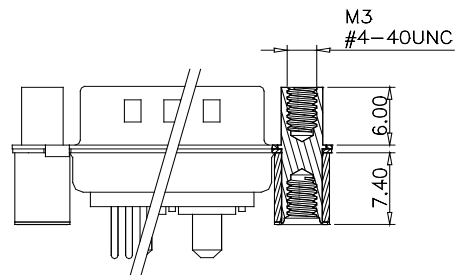

CODE:5/D

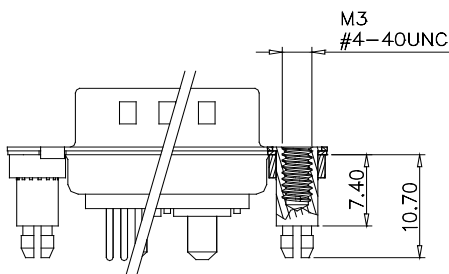

CODE:6/E

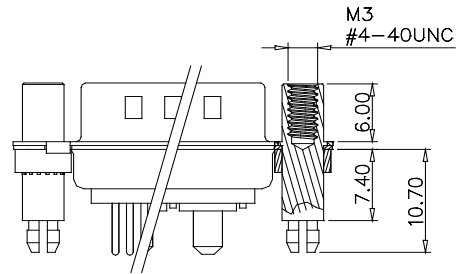

### Power Combo D-SUB

### PCB LAYOUT FOR MALE AND FEMALE CONNECTOR

CODE:5W1  
MALE/FEMALE

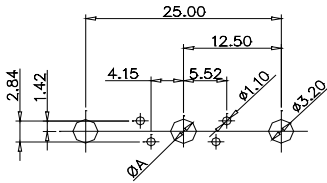

CODE:24W7  
MALE/FEMALE

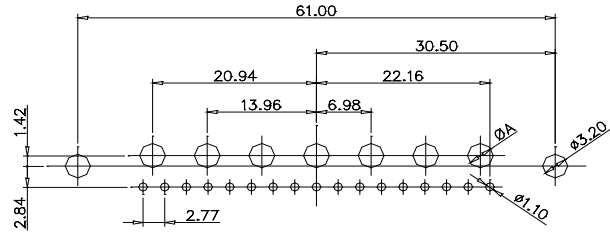

CODE:7W2  
MALE/FEMALE

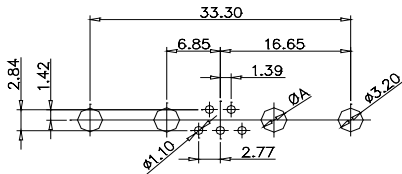

CODE:21W4  
MALE/FEMALE

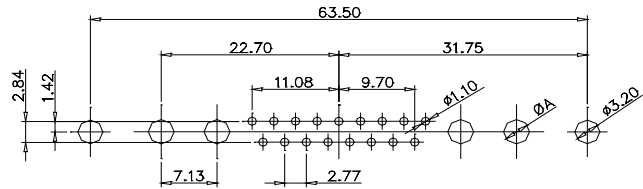

CODE:11W1  
MALE/FEMALE

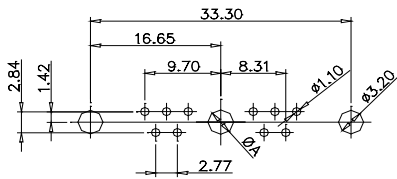

CODE:27W2  
MALE/FEMALE

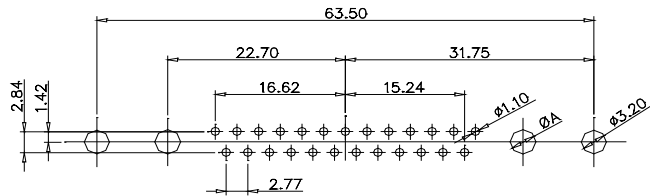

CODE:17W2  
MALE/FEMALE

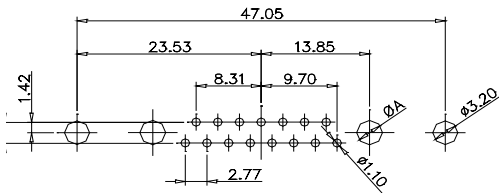

CODE:21W1  
MALE/FEMALE

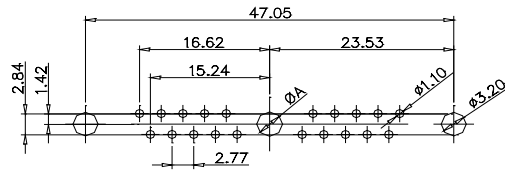

CURRENT RATING	10A	20A	30A	40A
$\phi A$ (mm)	2.2	3.3	3.7	4.2



### Power Combo D-SUB

### PCB LAYOUT FOR MALE CONNECTOR

CODE:9W4  
MALE

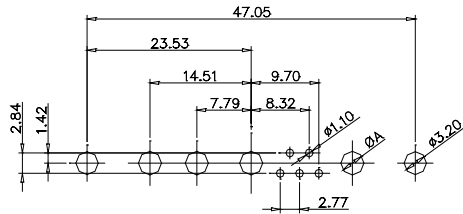

CODE:25W3  
MALE

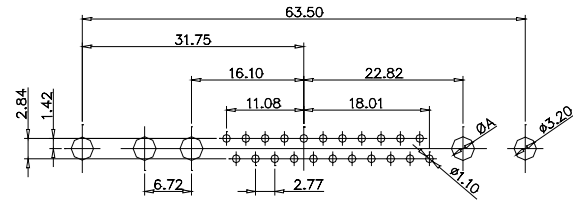

CODE:13W3  
MALE

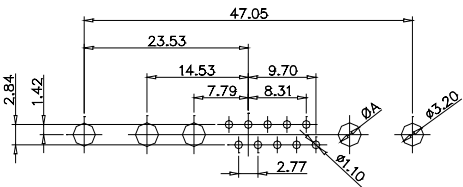

CODE:36W4  
MALE

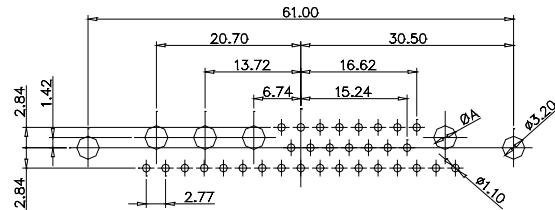

CODE:13W6  
MALE

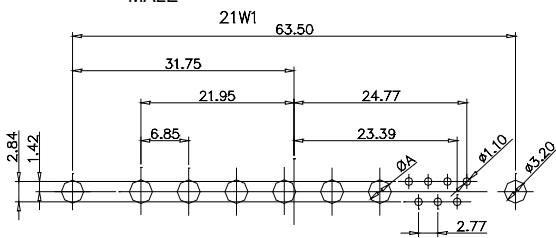

CODE:43W2  
MALE

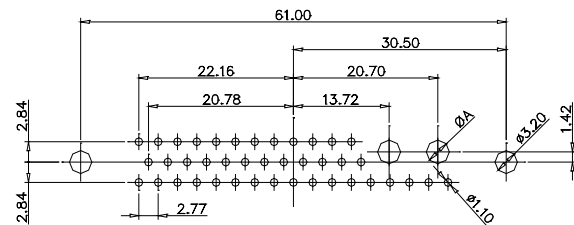

CODE:17W5  
MALE

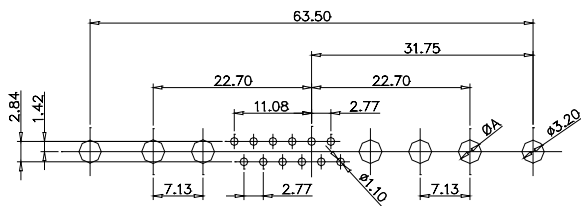

CODE:47W1  
MALE

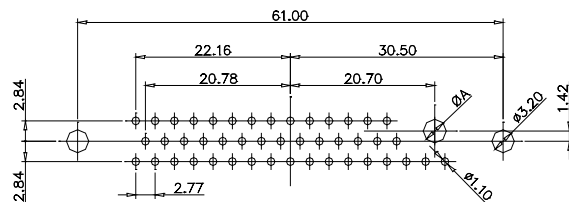

CURRENT RATING	10A	20A	30A	40A
ØA(mm)	2.2	3.3	3.7	4.2

### Power Combo D-SUB

### PCB LAYOUT FOR FEMALE CONNECTOR

CODE:9W4  
FEMALE

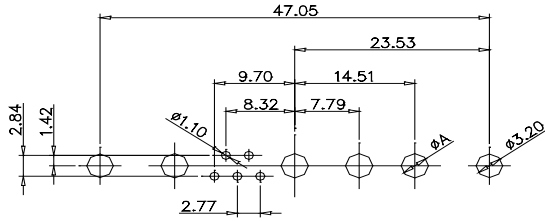

CODE:25W3  
FEMALE

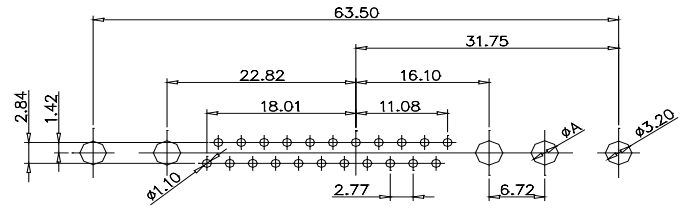

CODE:13W3  
FEMALE

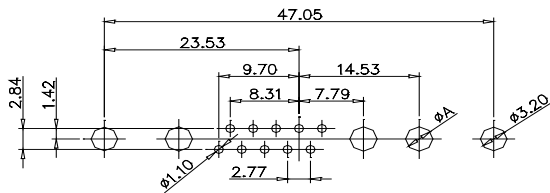

CODE:36W4  
FEMALE

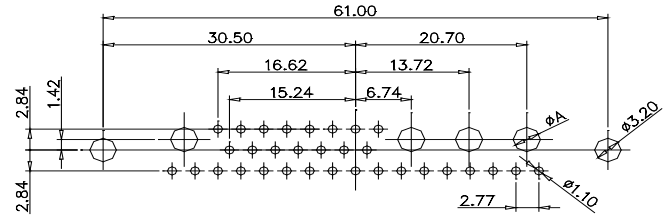

CODE:13W6  
FEMALE

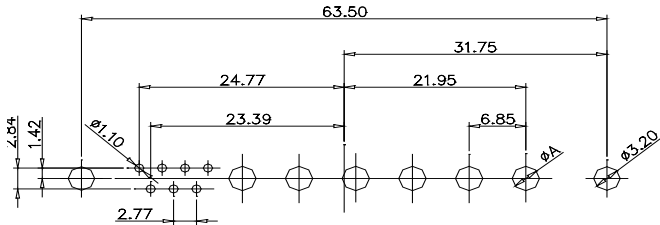

CODE:43W2  
FEMALE

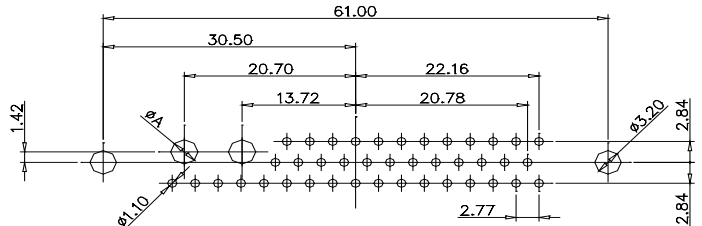

CODE:17W5  
FEMALE

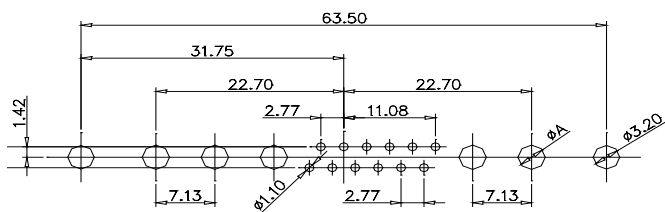

CODE:47W1  
FEMALE

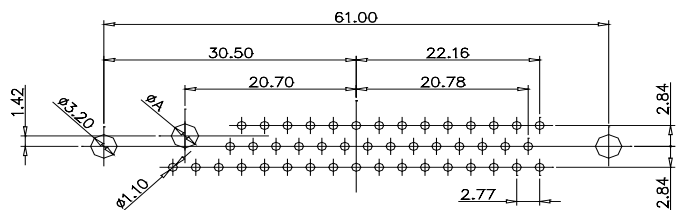

CURRENT RATING	10A	20A	30A	40A
ØA(mm)	2.2	3.3	3.7	4.2

## Power Combo D-Sub Connectors: Vertical

### STRAIGHT PCB TYPE MOUNTING OPTION

CODE:1

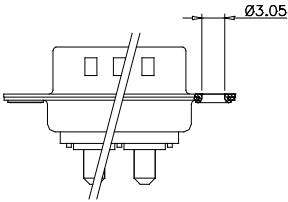

CODE:2/A

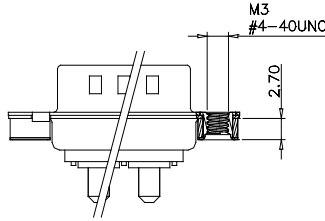

CODE:3/B

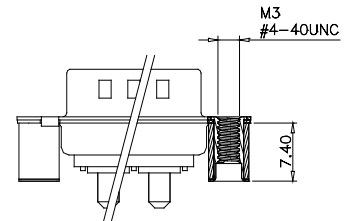

CODE:4/C

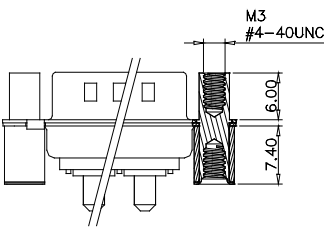

CODE:5/D

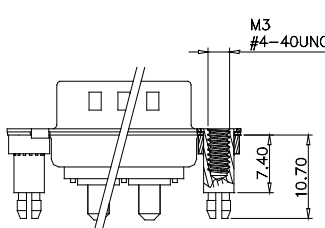

CODE:6/E

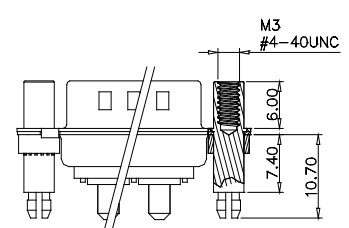

### PCB LAYOUT FOR POWER D-SUB MALE AND FEMALE CONNECTOR

CODE:2W2/2WK2

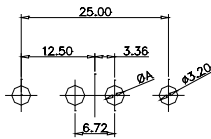

CODE:3W3/3WK3

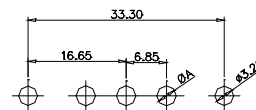

CODE:5W5 MALE

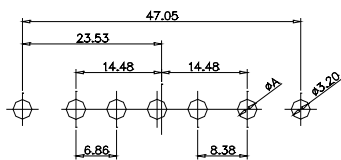

CODE:8W8 MALE

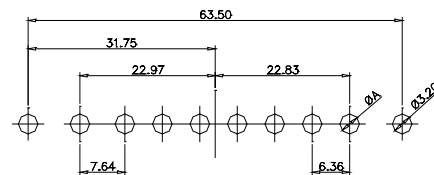

CODE:5W5 FEMALE

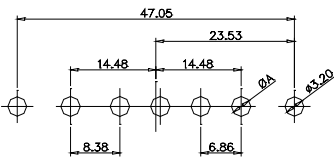

CODE:8W8 FEMALE

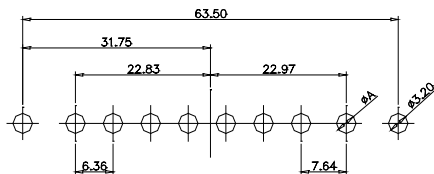

CURRENT RATING	10A	20A	30A	40A
ØA(mm)	2.2	3.3	3.7	4.2

### Coaxial Combo D-SUB

5W1 Male/Female

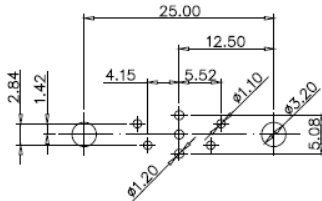

24W7 Male/Female

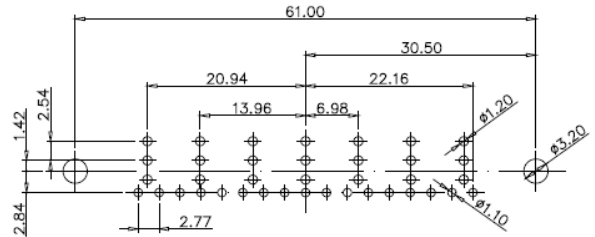

7W2 Male/Female

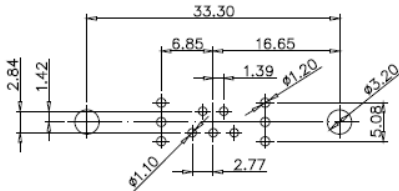

21W4 Male/Female

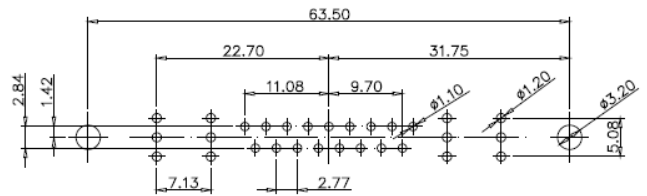

11W1 Male/Female

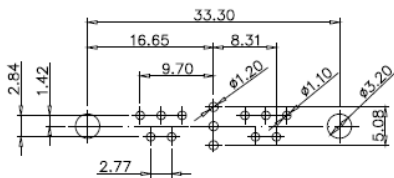

27W2 Male/Female

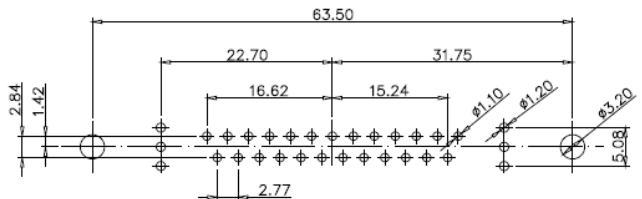

17W2 Male/Female

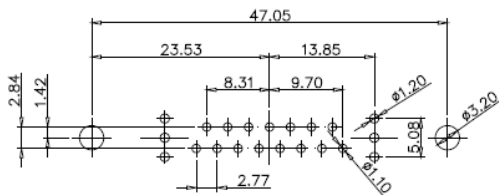

21W1 Male/Female

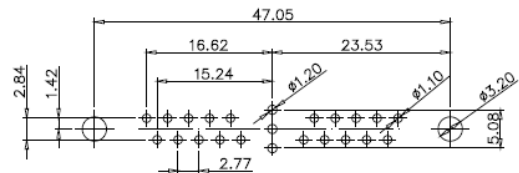

### Coaxial Combo D-SUB

9W4 Male

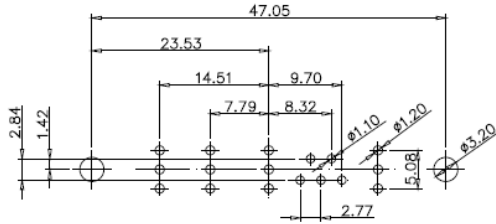

25W3 Male

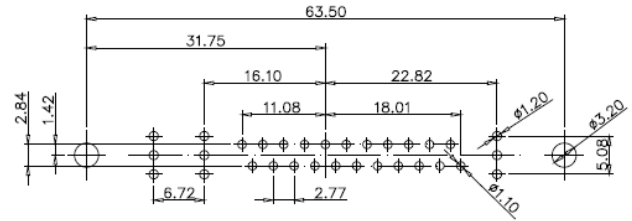

13W3 Male

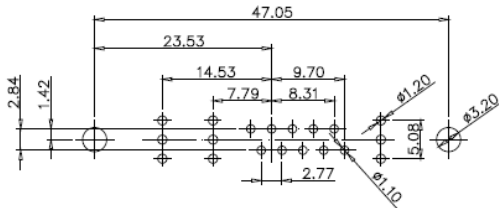

36W4 Male

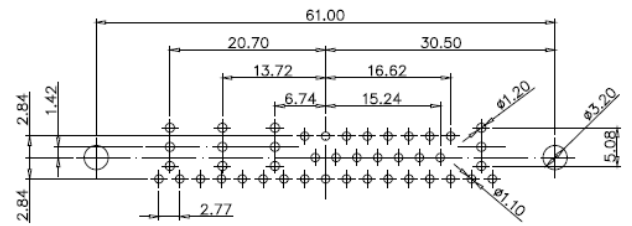

13W6 Male

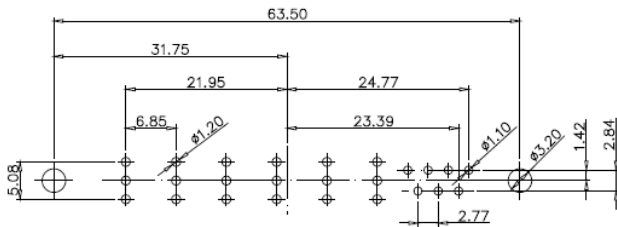

43W2 Male

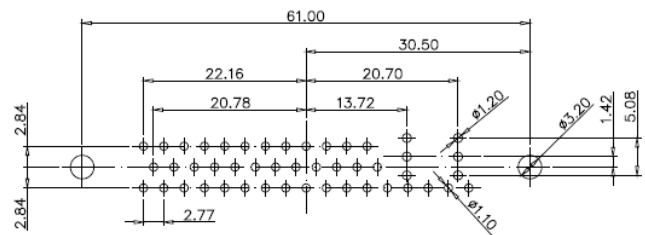

17W5 Male

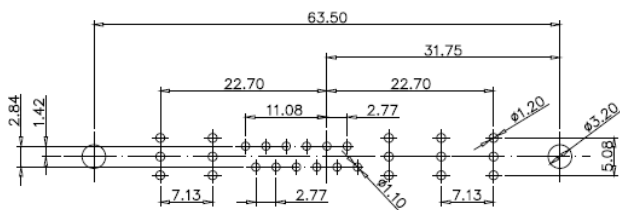

47W1 Male

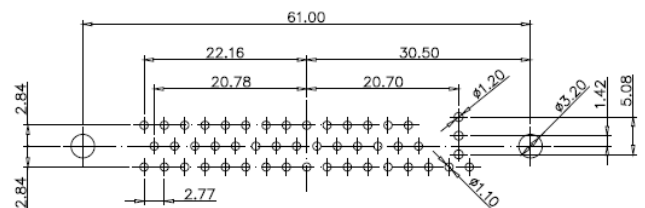

### Coaxial Combo D-SUB

9W4 Female

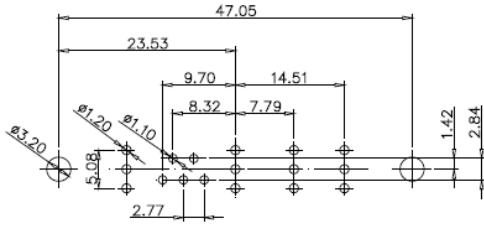

25W3 Female

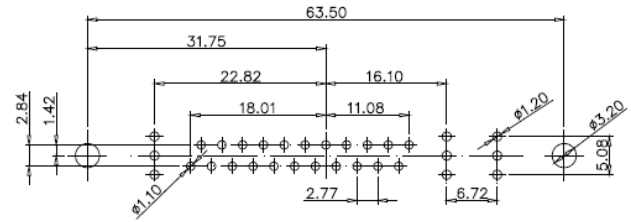

13W3 Female

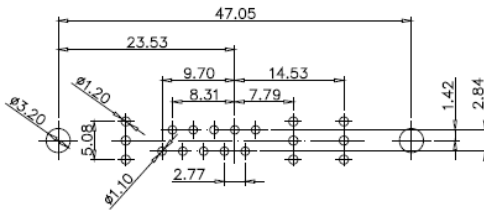

36W4 Female

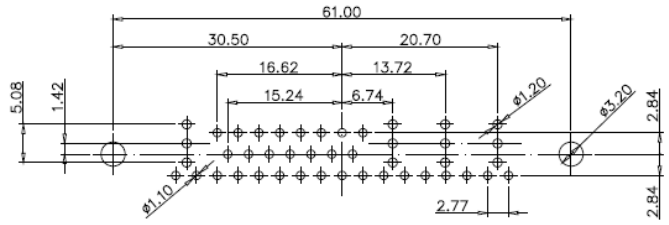

13W6 Female

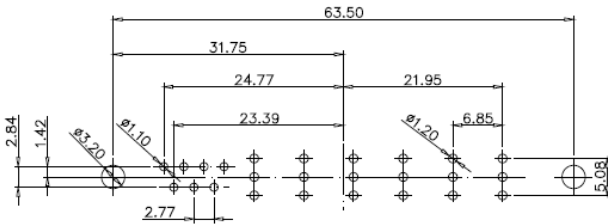

43W2 Female

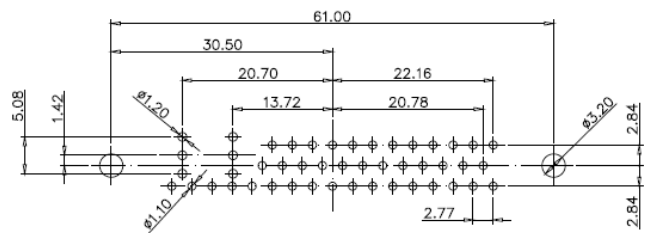

17W5 Female

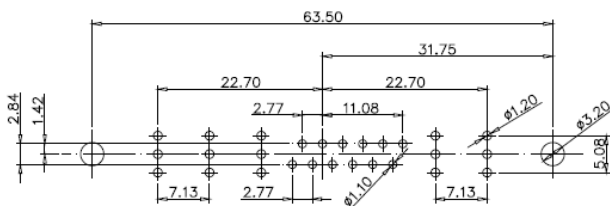

47W1 Female

