

Style

M12 Plug
5 pin
A-coding

Ratings

Voltage: 60 V
Current: 4 A

Operating Temperature Range

-40 ~ 105 °C

Materials

- ① Insulator: Polyamide 66 (PA66), black, UL94 HB
- ② Pin: C3604 brass, gold plated
- ③ Shell: C3604 brass, nickel plated

Electrical Requirements

Dielectric strength: 1 min @ 500 Vac
Insulation resistance: 100 MΩ @ 500 Vdc
Contact resistance: 10 mΩ or less

Mechanical Requirements

Life cycle: 500 mating cycles minimum

Environmental Requirements

Salt spray test: 35 °C, relative humidity 90-95%, 5% NaCl mist for 48 hrs. Wash parts after test. Maintain mechanical requirements and a contact resistance of less than 10 mΩ.
Waterproof: IP67

Assembly Info

Wire gauge: 22 AWG max

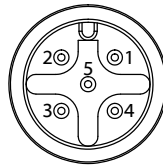
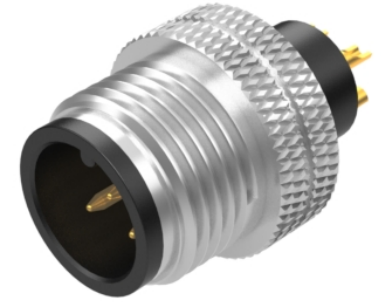

Front View
Not to Scale

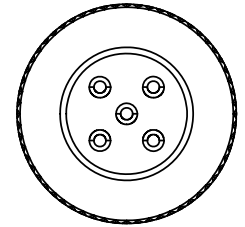
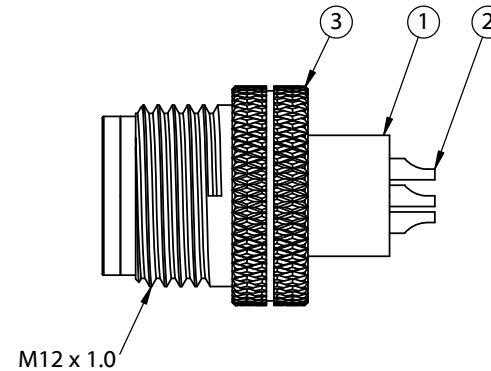
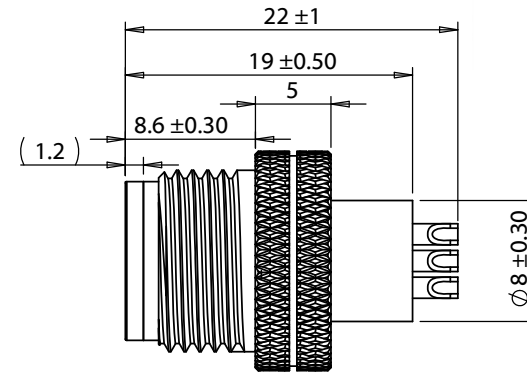
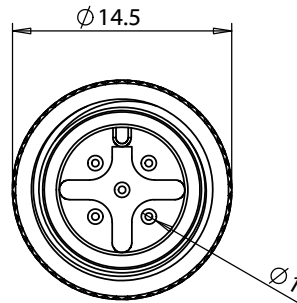

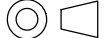
Revision:	Date:	Description:	Prepared:	Notes:	<h1>TENSILITY</h1> tel 1.541.323.3228 800 877.670.7118 fax 1.541.323.4202 web tensility.com	
A	8/4/2020	Initial release	JC <small>Digitally signed by JC Date: 2020.10.23 12:18:30 -07'00'</small>	RoHS compliant		
			Verified:	Function test: no open, no short circuit, no intermittent	Size:	
			AG <small>Digitally signed by AG Date: 2020.10.23 12:24:44 -07'00'</small>	Description:	A	
			Dimensions are in millimeters. Tolerances: X: ± 0.3 mm X.X: ± 0.1 mm X.XX: ± 0.05 mm	Connector, 5 pin M12 A-code plug, 12xL22mm, gold plated, molding style, solder cup, IP67	Part number: 50-00960	
					Scale: 2:1	
						Sheet 1 of 1