



WR-90 Waveguide Antenna, 8.2 GHz to 12.4 GHz  
Frequency Range, 20 dBi Gain, UG-135/U Flange

## Waveguide Antennas Technical Data Sheet

PEWAN090-20

### Features

- WR-90 Rectangular Waveguide Interface
- 8.2 GHz to 12.4 GHz
- 20 dBi Nominal Gain
- UG-135/U Cover Flange
- X Band

### Applications

- Antenna Measurements
- Wireless Communication
- Laboratory Use
- Microwave Radio Systems

### Description

The PEWAN090-20 X Band standard gain horn antenna (also known as waveguide horn) from Pasternack has a nominal gain of 20 dBi. This WR-90 standard gain horn has a UG-135/U type flange. The Pasternack 20 dBi WR-90 horn antenna operates from 8.2 GHz to 12.4 GHz. The WR-90 PEWAN090-20 waveguide horn is Powder coated Aluminum for added protection and corrosion resistance. It is part of over 40,000 RF, microwave and millimeter wave components available from Pasternack. Waveguide standard gain horn antennas are used in a wide variety of applications due to their high power handling capability, low loss, high directivity, and near constant electrical performance. Pasternack's WR-90 standard gain horns are available in 10, 15 and 20 dBi models with pyramidal shape and rectangular input. Our WR-90 standard gain horn antennas can ship worldwide the same day as it is purchased as with our other available RF parts.

### Configuration

Design	WR-90
Polarization	Linear

### Electrical Specifications

Description	Minimum	Typical	Maximum	Units
Frequency Range	8.2		12.4	GHz
Nominal Gain		20		dB
Horizontal Half Power Beam Width		17.5		Degrees
Vertical Half Power Beam Width		17.3		Degrees
VSWR		1.3:1		

### Mechanical Specifications

<b>Size</b>	
Length	9.37 in [238 mm]
Width	4.401 in [111.79 mm]
Height	3.265 in [82.93 mm]
Weight	0.5 lbs [226.8 g]

### Waveguide Interface

Waveguide Size	WR-90
----------------	-------

Click the following link (or enter part number in "SEARCH" on website) to obtain additional part information including price, inventory and certifications: [WR-90 Waveguide Antenna, 8.2 GHz to 12.4 GHz Frequency Range, 20 dBi Gain, UG-135/U Flange PEWAN090-20](#)



WR-90 Waveguide Antenna, 8.2 GHz to 12.4 GHz  
Frequency Range, 20 dBi Gain, UG-135/U Flange

Waveguide Antennas Technical Data Sheet

PEWAN090-20

Flange Type  
Flange Designation  
Body Material and Plating

Square Cover  
UG-135/U  
Aluminum, Gray

**Compliance Certifications** (see [product page](#) for current document)

**Plotted and Other Data**

**Typical Performance Data**

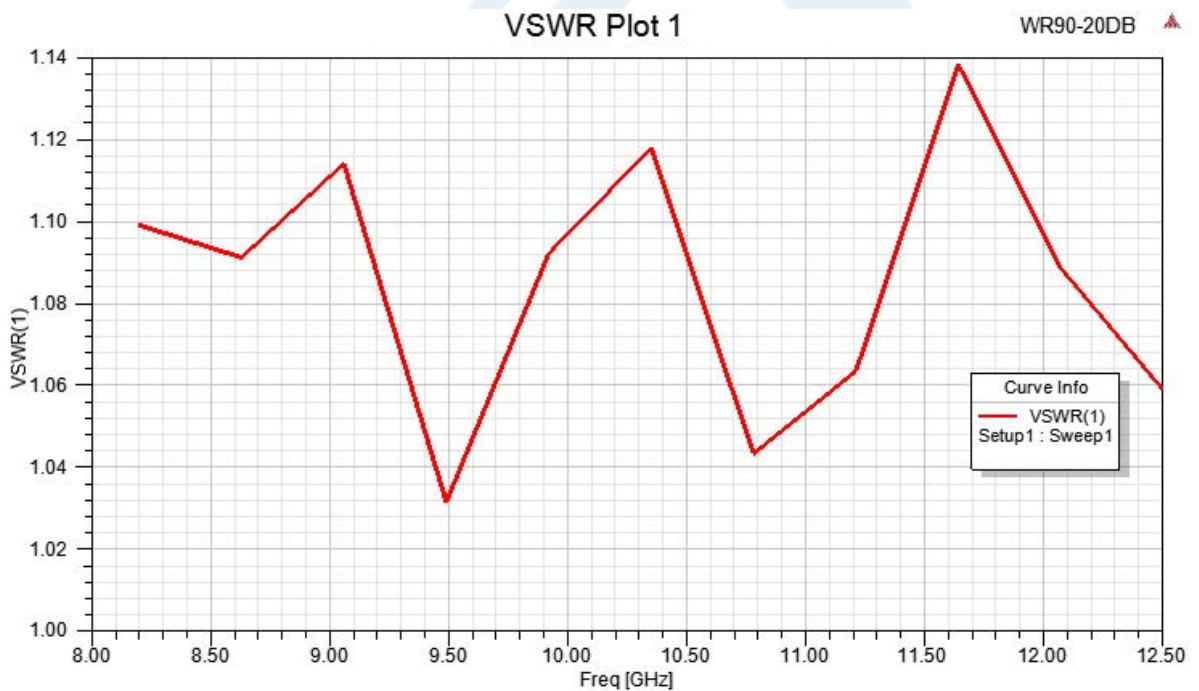

Click the following link (or enter part number in "SEARCH" on website) to obtain additional part information including price, inventory and certifications: [WR-90 Waveguide Antenna, 8.2 GHz to 12.4 GHz Frequency Range, 20 dBi Gain, UG-135/U Flange PEWAN090-20](#)



WR-90 Waveguide Antenna, 8.2 GHz to 12.4 GHz  
Frequency Range, 20 dBi Gain, UG-135/U Flange

Waveguide Antennas Technical Data Sheet

PEWAN090-20

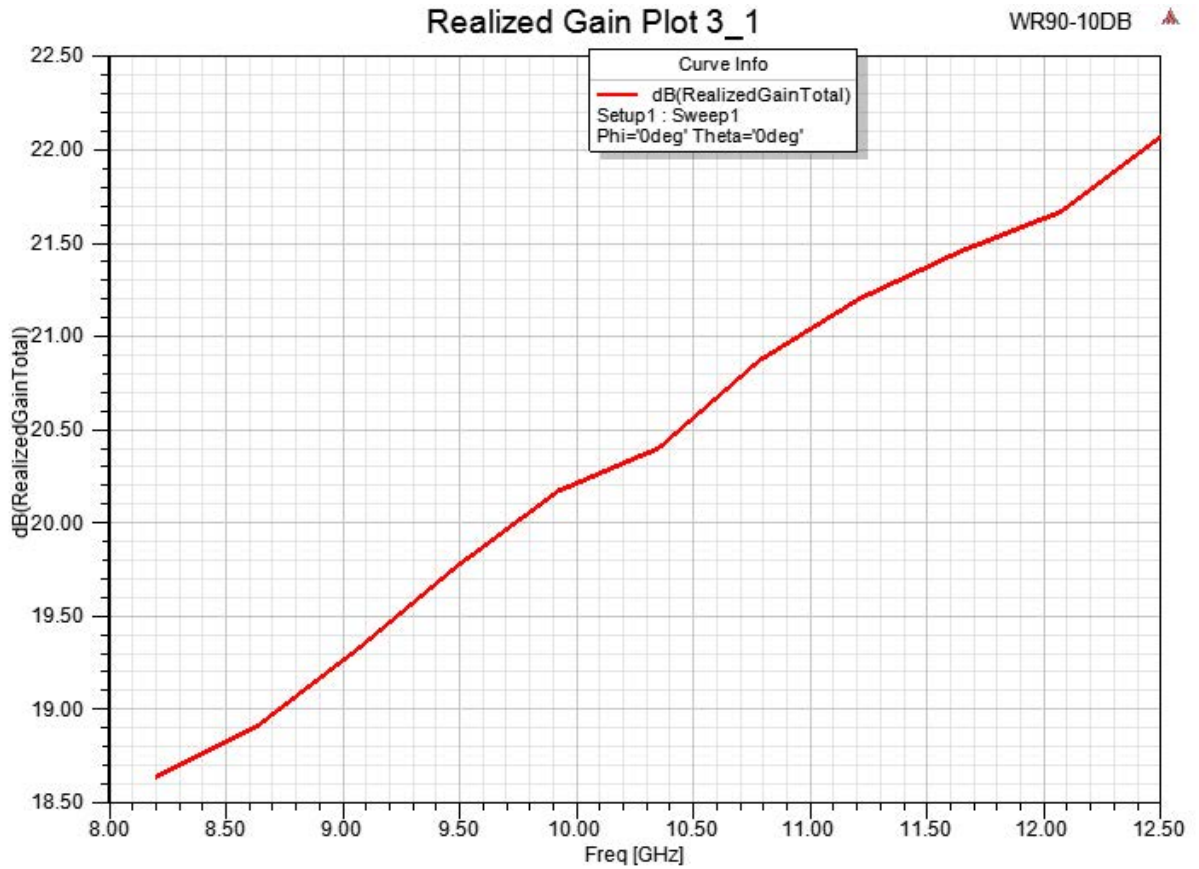

Click the following link (or enter part number in "SEARCH" on website) to obtain additional part information including price, inventory and certifications: [WR-90 Waveguide Antenna, 8.2 GHz to 12.4 GHz Frequency Range, 20 dBi Gain, UG-135/U Flange PEWAN090-20](#)



WR-90 Waveguide Antenna, 8.2 GHz to 12.4 GHz  
Frequency Range, 20 dBi Gain, UG-135/U Flange

Waveguide Antennas Technical Data Sheet

PEWAN090-20

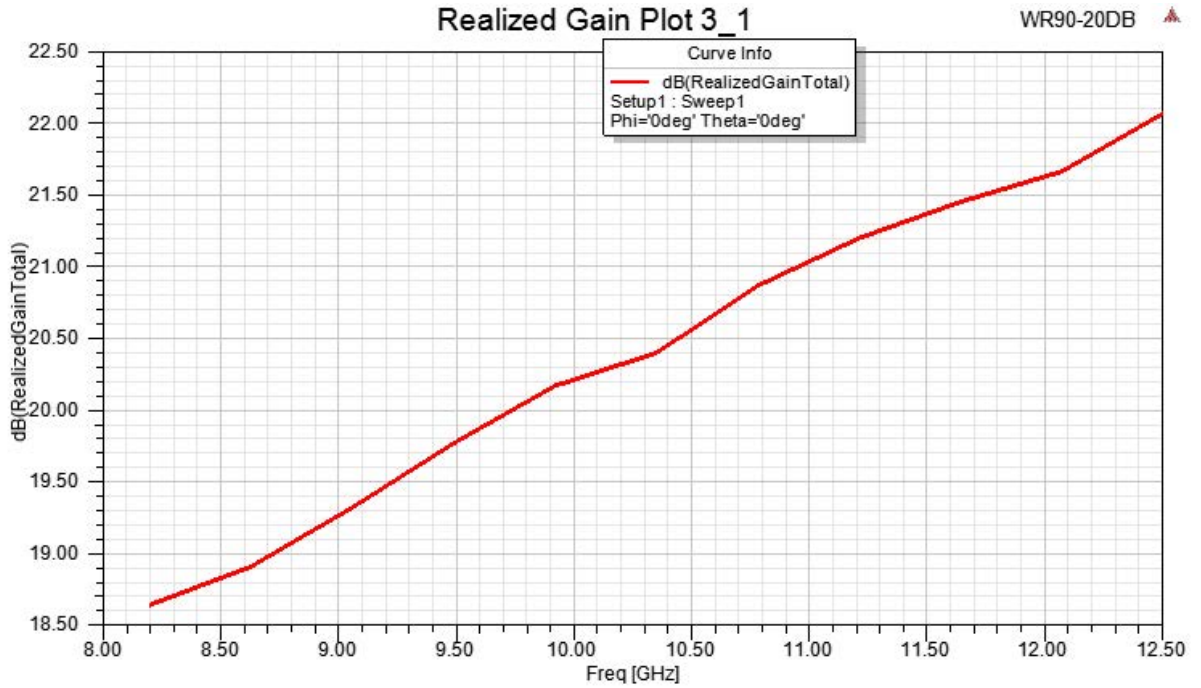

Click the following link (or enter part number in "SEARCH" on website) to obtain additional part information including price, inventory and certifications: [WR-90 Waveguide Antenna, 8.2 GHz to 12.4 GHz Frequency Range, 20 dBi Gain, UG-135/U Flange PEWAN090-20](#)



WR-90 Waveguide Antenna, 8.2 GHz to 12.4 GHz  
Frequency Range, 20 dBi Gain, UG-135/U Flange

Waveguide Antennas Technical Data Sheet

PEWAN090-20

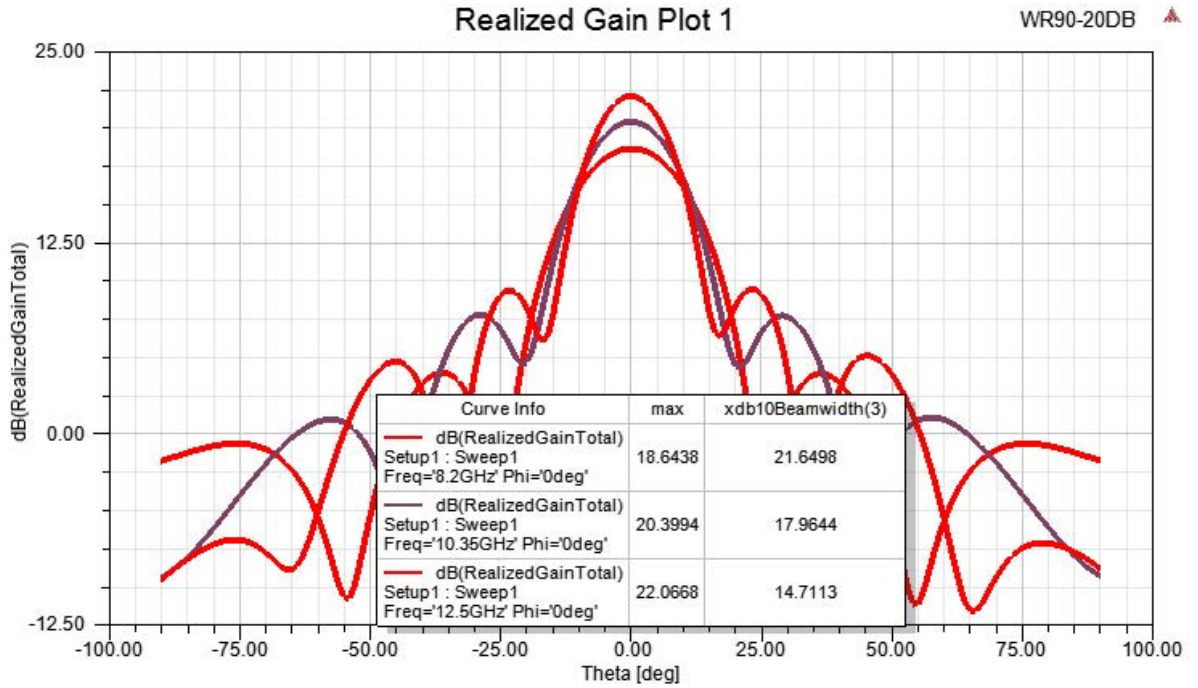

Click the following link (or enter part number in "SEARCH" on website) to obtain additional part information including price, inventory and certifications: [WR-90 Waveguide Antenna, 8.2 GHz to 12.4 GHz Frequency Range, 20 dBi Gain, UG-135/U Flange PEWAN090-20](#)





WR-90 Waveguide Antenna, 8.2 GHz to 12.4 GHz  
Frequency Range, 20 dBi Gain, UG-135/U Flange

Waveguide Antennas Technical Data Sheet

PEWAN090-20

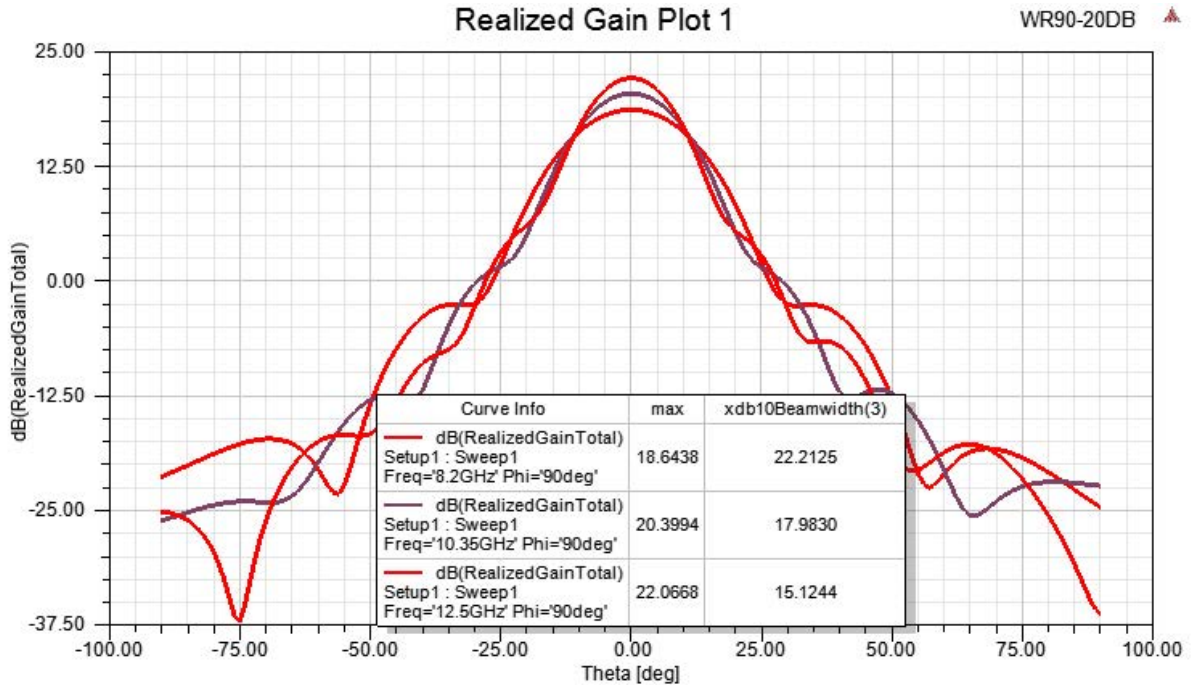

WR-90 Waveguide Antenna, 8.2 GHz to 12.4 GHz Frequency Range, 20 dBi Gain, UG-135/U Flange from Pasternack Enterprises has same day shipment for domestic and International orders. Our RF, microwave and millimeter wave products maintain a 99.4% availability and are part of the broadest selection in the industry.

Click the following link (or enter part number in "SEARCH" on website) to obtain additional part information including price, inventory and certifications: [WR-90 Waveguide Antenna, 8.2 GHz to 12.4 GHz Frequency Range, 20 dBi Gain, UG-135/U Flange PEWAN090-20](#)

URL: <https://www.pasternack.com/wr-90-waveguide-gain-horn-antenna-20db-ug-135-square-flange-pewan090-20-p.aspx>

The information contained in this document is accurate to the best of our knowledge and representative of the part described herein. It may be necessary to make modifications to the part and/or the documentation of the part, in order to implement improvements. Pasternack reserves the right to make such changes as required. Unless otherwise stated, all specifications are nominal. Pasternack does not make any representation or warranty regarding the suitability of the part described herein for any particular purpose, and Pasternack does not assume any liability arising out of the use of any part or documentation.

# PEWAN090-20 CAD Drawing

WR-90 Waveguide Antenna, 8.2 GHz to 12.4 GHz Frequency Range, 20 dBi Gain, UG-135/U Flange

REVISIONS			
REV.	DESCRIPTION	DATE	APPROVED
A	INITIAL RELEASE	06/11/2021	KHIETPAS

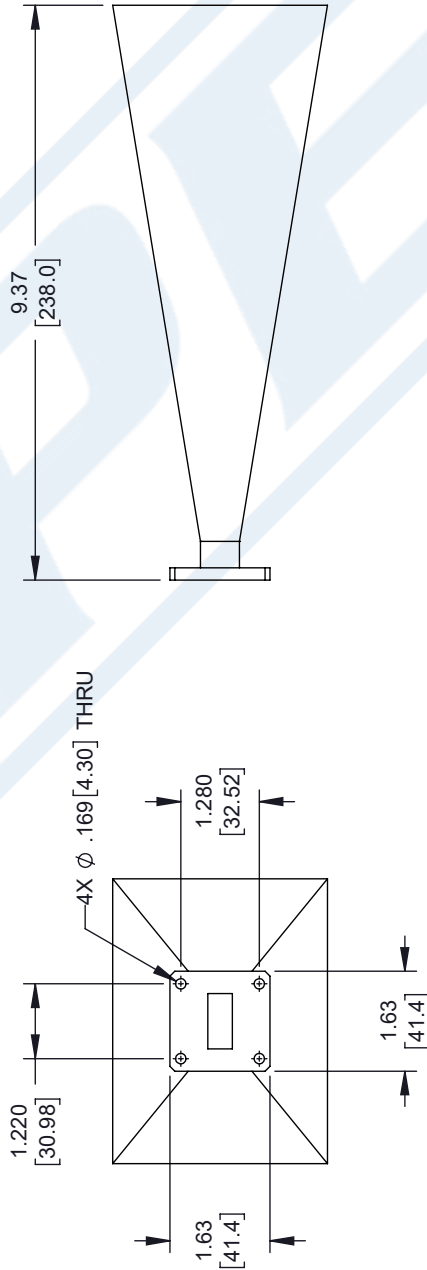
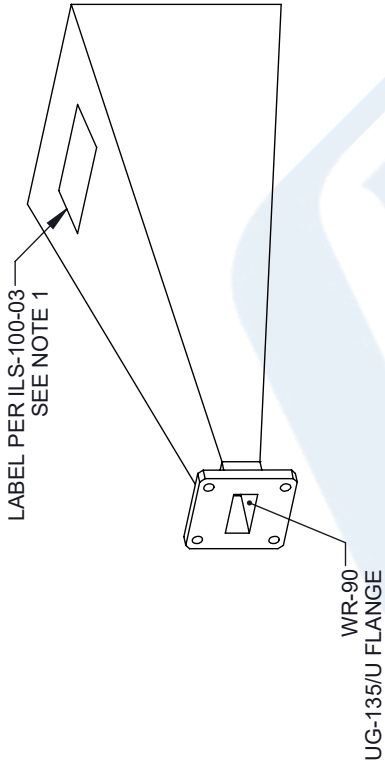

<p>Pasternack Enterprises, Inc. P. O. Box 16759, Irvine, CA 92623. Phone: 1.949.261.1920   1.866.727.8376 Fax: 1.949.261.7451 Website: www.pasternack.com E-mail: sales@pasternack.com</p>	<p>THIRD-ANGLE PROJECTION</p> <p>THE INFORMATION AND DESIGN IN THIS DOCUMENT IS THE PROPERTY OF PASTERNAK CORPORATION. ALL RIGHTS RESERVED.</p> <p>SHEET 1 OF 1</p> <p>SCALE N/A</p>
	<p>UNLESS OTHERWISE SPECIFIED LEADING DIMENSIONS ARE INCHES DIMENSIONS IN [ ] ARE MILLIMETERS</p> <p>TOLERANCES:</p> <p>.X = ±.2 [5.08]    FRACTIONS ±.1/32 .XX = ±.02 [ .51]    ANGLES ± 1° .XXX = ±.005 [ .13]</p> <p>CABLE LENGTH (L), TOLERANCES: L ≤ 12 [305] = +1 [25] / -0 12 [305] &lt; L ≤ 60 [1524] = +2 [51] / -0 60 [1524] &lt; L ≤ 120 [3048] = +4 [102] / -0 120 [3048] &lt; L ≤ 300 [7620] = +6 [152] / -0 300 [7620] &lt; L = +5% / -0</p> <p>ALL DIMENSIONS SHOWN ARE FOR REFERENCE ONLY.</p>
<p>ITEM NO. PEWAN090-20</p>	<p>REV. A</p>
<p>CAGE CODE 53919</p>	<p>DRAWN BY DZINN</p>

NOTES:  
1. LABEL PER ILS-100-03 (FOR INTERNAL REFERENCE ONLY)  
LABEL LOCATION FOR REFERENCE ONLY

THESE COMMODITIES, TECHNOLOGY OR SOFTWARE WERE EXPORTED FROM THE UNITED STATES IN ACCORDANCE WITH THE EXPORT ADMINISTRATION REGULATIONS. DIVERSION CONTRARY TO U.S. LAW PROHIBITED.