

# EL CONNECTOR

4.5 mm pitch/Disconnectable Crimp style Wire-to-wire connectors

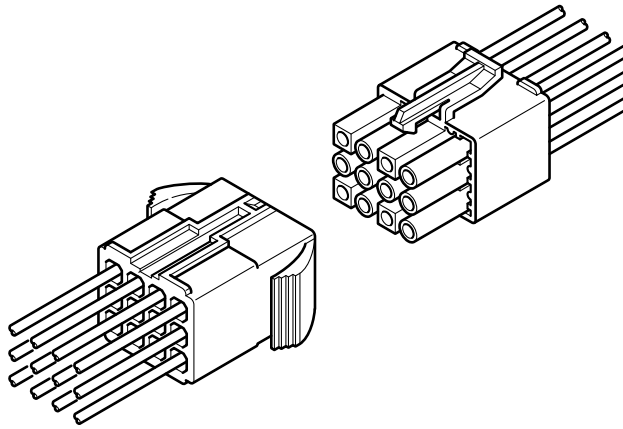

The contacts for the compact EL connector can be easily inserted into the connector housings. The plug housing and the receptacle housing can be smoothly mated even if they are mechanically distorted.

- Easy insertion and secure installation of contacts
- A smooth connection even when pried during mating
- Durable arm lock mechanism
- Two contact styles
- Interchangeability with ML connector

## Specifications

- Current rating: 10 A AC/DC
  - Voltage rating: 300 V AC/DC
  - Temperature range: -25°C to +90°C  
(including temperature rise in applying electrical current)
  - Contact resistance: Initial value/ 7 mΩ max.  
After environmental tests/ 10 mΩ max.
  - Insulation resistance: 1,000 MΩ min.
  - Withstanding voltage: 1,500 VAC/minute
  - Applicable wire: AWG #26 to #16  
0.13 to 1.25 mm<sup>2</sup>
  - Applicable panel thickness: 0.8 to 2.0 mm
- \* In using the products, refer to "Handling Precautions for Terminals and Connectors" described on our website (Technical documents of Product information page).
- \* RoHS2 compliance
- \* Dimensional unit: mm
- \* Contact JST for details.

Note: The current rating varies depending on the number of circuits and the wire size used in each connector. The table below lists the current rating as a function of the number of circuits and the wire size.

Current unit : A

No. of circuits	Wire size (AWG)					
	#16	#18	#20	#22	#24	#26
2	10	6	5	4	4	3
3	10	6	5	4	4	3
4	10	6	5	4	4	3
6	8	5	4	3	3	3
9	6	4	3	3	2	2
12	6	4	3	3	2	2
15	6	4	3	3	2	2

## Standards

- Ⓜ Recognized E60389
- Ⓢ Certified LR20812
- ⚠ R75052

## Panel layout and Assembly layout

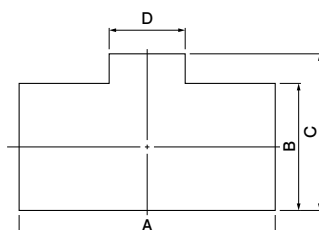
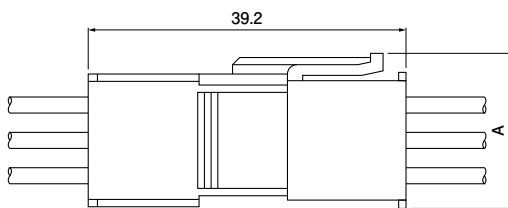

No. of circuits	Dimensions A (mm)
2~4 (Single-line arrangement)	10.4
4 (Double-line arrangement)	15.0
6	14.9
9~15	19.4

No. of circuits	Receptacle housing Model No.	Panel hole dimensions (mm)				General tolerance ±0.13	Applicable panel thickness (mm)
		A	B	C	D		
2	ELR-02V	15.0	6.0	6.85	5.2	0.8~2.0	
3	ELR-03V	19.7	6.0	6.85	5.2		
4	ELR-04V	24.2	6.0	6.85	5.2		
	ELR-04NV	15.6	10.6	11.6	5.2		
6	ELR-06V	19.7	10.2	11.1	5.2		
9	ELR-09V	19.7	14.8	15.7	5.2		
12	ELR-12V	24.2	14.8	15.7	5.2		
15	ELR-15V	28.7	14.8	15.7	5.2		

- Note: 1. Punch holes in the panel according to the figures and table shown above. Burrs must be removed.  
 2. The strength of the panel must be considered when punching two or more holes.  
 3. The connector must be inserted from the same side as the hole is punched.

# EL CONNECTOR

## Contact

### Pin contact

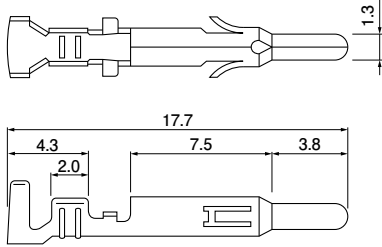

### Socket contact

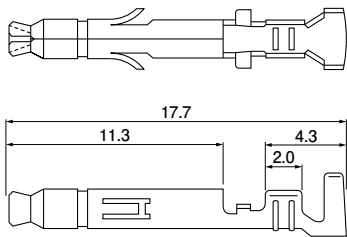

Model No.		Applicable wire		Insulation O.D. (mm)	Q'ty/reel
Pin contact	Socket contact	mm <sup>2</sup>	AWG #		
SLM-01T-P1.3E	SLF-01T-P1.3E	0.13~0.5	26~20	1.3~2.7	6,000
SLM-41T-P1.3E	SLF-41T-P1.3E	0.5~1.25	20~16	1.9~3.4	4,000
*SLM-42T-P1.3E	*SLF-42T-P1.3E	0.3+0.3~ 0.5+0.5	22+22~ 20+20	1.7+1.7~ 2.0+2.0	

### Material and Finish

Phosphor bronze, tin-plated (reflow treatment)

### RoHS2 compliance

- Note: 1. Contact denoted by \* is used for two wires.  
 2. Contact JST for special products.  
 3. Contact JST for brass products.

Contact	Crimping machine	Applicator		
		Crimp applicator	Dies	Crimp applicator with dies
SLM-01T-P1.3E	AP-K2N	MKS-L	MK/SLF/M-01-13E	APLMK SLF/M01-13E
SLF-01T-P1.3E				
SLM-42T-P1.3E			MK/SLF/M-42-13E	APLMK SLF/M42-13E
SLF-42T-P1.3E				
SLM-41T-P1.3E			MK/SLF/M-41-13E	APLMK SLF/M41-13E
SLF-41T-P1.3E				

Note: Contact JST for fully automatic crimping applicator.

## Contact position location numbers

Contact position numbers are stamped

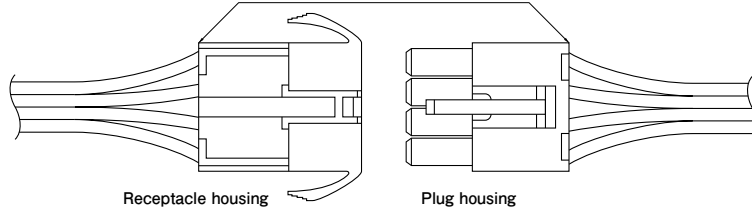

Receptacle housing

Plug housing

### Receptacle housing

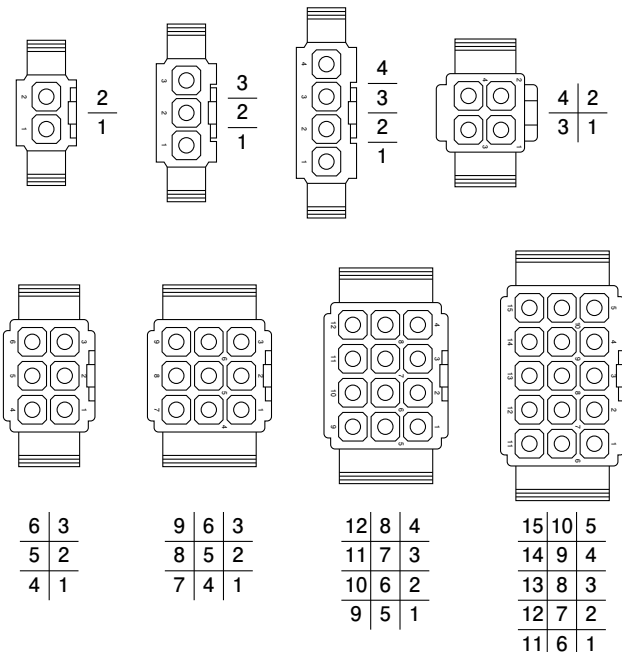



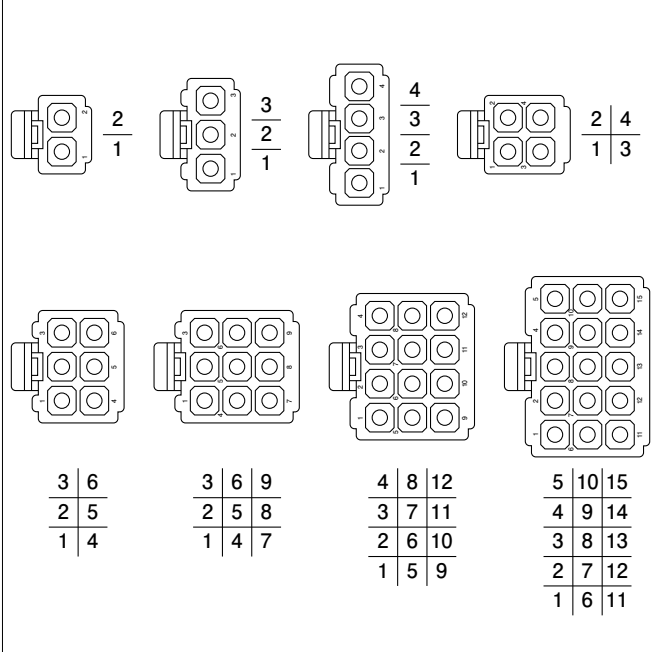





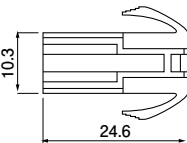
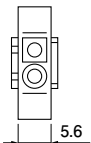

### Plug housing

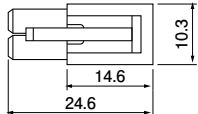
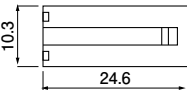

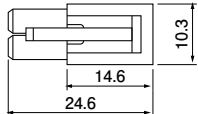
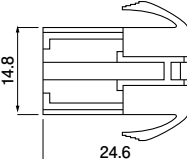
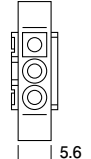
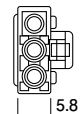
# EL CONNECTOR

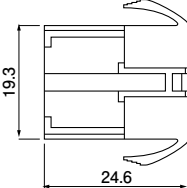
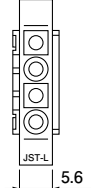
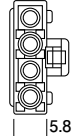
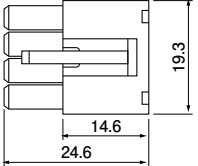
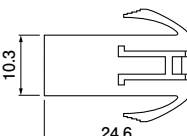
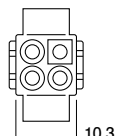
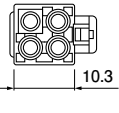
## Housing

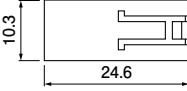
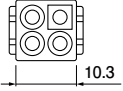
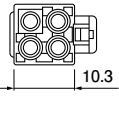
Material: PA 6, UL94V-0, white

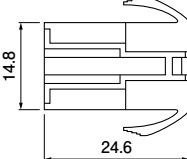
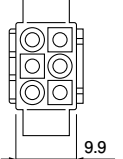
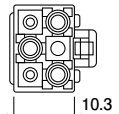
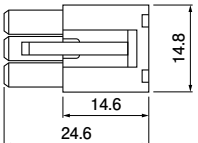
No. of circuits	Voltage rating	Current rating	Receptacle housing (for pin contact)		Plug housing (for socket contact)					
2	300 V	10 A	ELR-02V			Q'ty/ bag	ELP-02V			Q'ty/ bag
			500	5.6	5.8	500				
2	300 V	10 A	ELR-02VF			Q'ty/ bag	ELP-02V			500
			500	5.8	5.8	500				
3	300 V	10 A	ELR-03V			Q'ty/ bag	ELP-03V			Q'ty/ bag
			500	5.6	5.8	500				
4	300 V	10 A	ELR-04V			Q'ty/ bag	ELP-04V			Q'ty/ bag
			500	5.6	5.8	500				
4	300 V	10 A	ELR-04NV			Q'ty/ bag	ELP-04NV			Q'ty/ bag
			500	10.3	10.3					
4	300 V	10 A	ELR-04NVF			500	ELP-04NV			500
			500	10.3	10.3					
6	300 V	8 A	ELR-06V			Q'ty/ bag	ELP-06V			Q'ty/ bag
			500	9.9	10.3	500				

RoHS2 compliance

# EL CONNECTOR

## Housing

Material: PA 6, UL94V-0, white

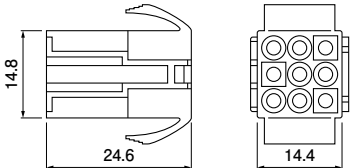
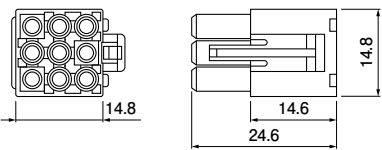
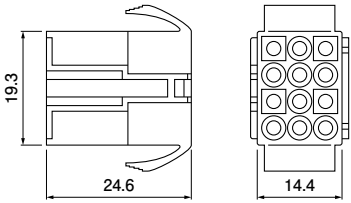
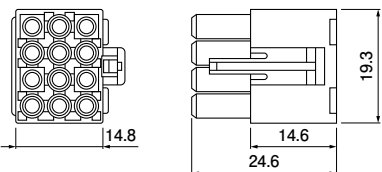
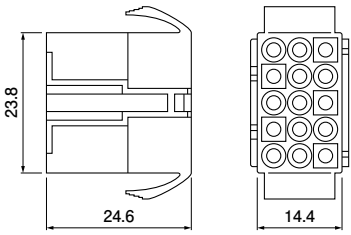
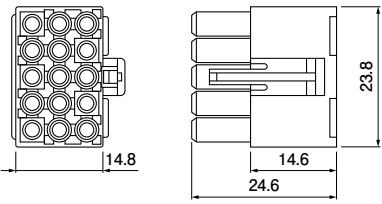
No. of circuits	Voltage rating	Current rating	Receptacle housing (for pin contact)		Plug housing (for socket contact)		
9	300 V	6 A	ELR-09V		Q'ty/ bag	ELP-09V	Q'ty/ bag
				500		500	
12	300 V	6 A	ELR-12V		Q'ty/ bag	ELP-12V	Q'ty/ bag
				500		500	
15	300 V	6 A	ELR-15V		Q'ty/ bag	ELP-15V	Q'ty/ bag
				500		500	

### RoHS2 compliance

Note: 1. ELR-02VF and ELR-04NVF are exclusively for free hanging. The other circuits can be used either for panel mounted or free hanging.

See "Panel layout" for the panel hole dimensions.

2. Contact JST for special products.