

**Introducing**  
**SMT and Thru-Hole Poke-In**  
**Wire Lighting Connectors**  
**(Gel-Filled Option Available for Sealed Applications)**

# SMT and Thru-Hole Poke-In Wire Lighting Connectors

(Gel-Filled Option Available  
for Sealed Applications)



Our commitment. Your advantage.

## KEY FEATURES

- Connectors are available in 1 and 2 positions
- Standard and Low Insertion Force connectors available
- Accepts 18, 20 and 22 AWG solid wire; 18 and 20 AWG pre-bond stranded wire; 18 AWG stranded wire
- Connectors are available in both black and white colors for polarity
- Gel-filled versions are available for indoor moisture and outdoor application
- Low profile design
- Rounded corners to minimize shadowing
- Flat top surface allows for vacuum pickup
- High temperature material for reflow processing
- Redundant SMT pads prevent peeling
- Side by side stackable with pads on 4mm centers
- Tape and reel packaging for high speed SMT and Thru Hole processing
- RoHS compliant
- Cost effective alternative to hand soldering wires to printed circuit boards

## DESCRIPTION

The low profile SMT and Thru-Hole Poke-In Wire connectors are designed for lighting applications

Available in surface mount and thru-hole tape and reel packaging, the connectors are designed to accept a wide range of wire sizes and types

## APPLICATIONS

LED Lighting Controls

General illumination LED fixtures

Interconnecting strings of printed circuit LED light modules

Various non-lighting applications that require attaching flying leads to printed circuit boards

## ELECTRICAL

250VAC / 5A

250VDC / 5A

1500VAC dielectric withstanding voltage

## MECHANICAL

Operating Temperature: -40° to +105° C

Wire Retention: 5 lbs minimum

## MATERIALS

Housing: UL 94 VO rated high temperature resistant thermoplastic

Contacts: Tin over nickel plated copper alloy

## STANDARDS & SPECS

- Standard Product Application Specification: 114-13194
- Standard Product Design Objectives (Product Specification) 108-2284
- Low Insertion Force Application Specification: 114-13226
- Low Insertion Force Design Objectives (Product Specification) 108-2284-1

# SMT and Thru-Hole Poke-In Wire Lighting Connectors

## PRODUCT OFFERING

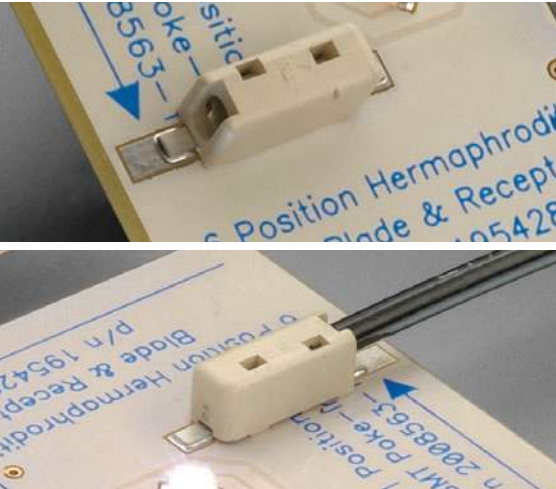

### Standard Product Offering:

- 1 Position SMT: 2008563-1
- 1 Position SMT: 2008563-2 (Color: Black)
- 2 Position SMT: 1954097-1
- 1 Position Thru-Hole: 2008839-1
- 2 Position Thru-Hole: 2008106-1

### Wire Sizes:

- 18, 20 and 22 AWG Solid
- 18 & 20 AWG Pre-bond Stranded
- 18 AWG Stranded (16 Strands Only)

### Low Insertion Force Product Offering:

- 1 Position SMT: 2008683-1
- 1 Position SMT: 1-2008683-1 (Color: Black)
- 2 Position SMT: 2008683-2
- 2 Position SMT: 1-2008683-2 (Color: Black)
- 1 Position Thru-Hole: 2008683-3
- 1 Position Thru-Hole: 1-2008683-3 (Color: Black)
- 2 Position Thru-Hole: 2008683-4
- 2 Position Thru-Hole: 1-2008683-4 (Color: Black)

### Wire Sizes:

- 18 and 20 AWG Solid
- 18 & 20 AWG Pre-bond Stranded
- 18 AWG Stranded (7, 9 & 16 Strands Only)

### Standard Gel-Filled Product Offering:

- 1 Position SMT: 2008994-1
- 2 Position SMT: 1954785-1
- 1 Position Thru-Hole: 2008995-1
- 2 Position Thru-Hole: 2008996-1

### Wire Sizes:

- 18, 20 and 22 AWG Solid
- 18 & 20 AWG Pre-bond Stranded
- 18 AWG Stranded (16 Strands Only)



# SMT and Thru-Hole Poke-In Wire Lighting Connectors

## PRODUCT DIMENSIONS

**2 Position SMT**  
Part No. 1954097-1

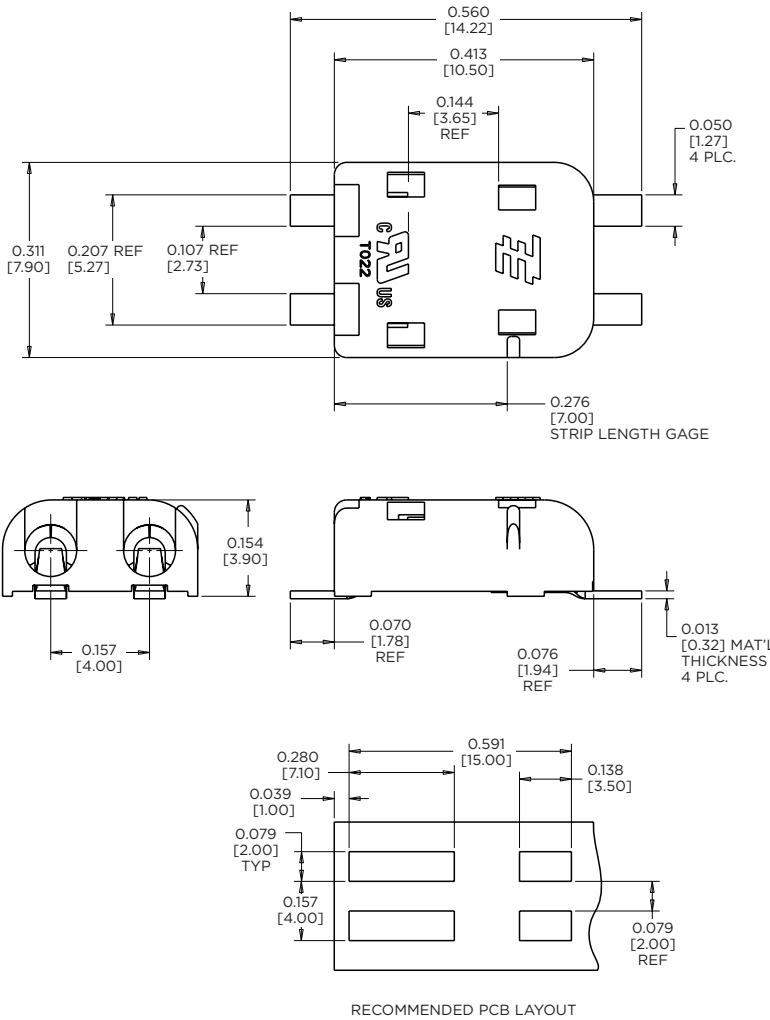

**1 Position SMT**  
Part No. 2008563-1

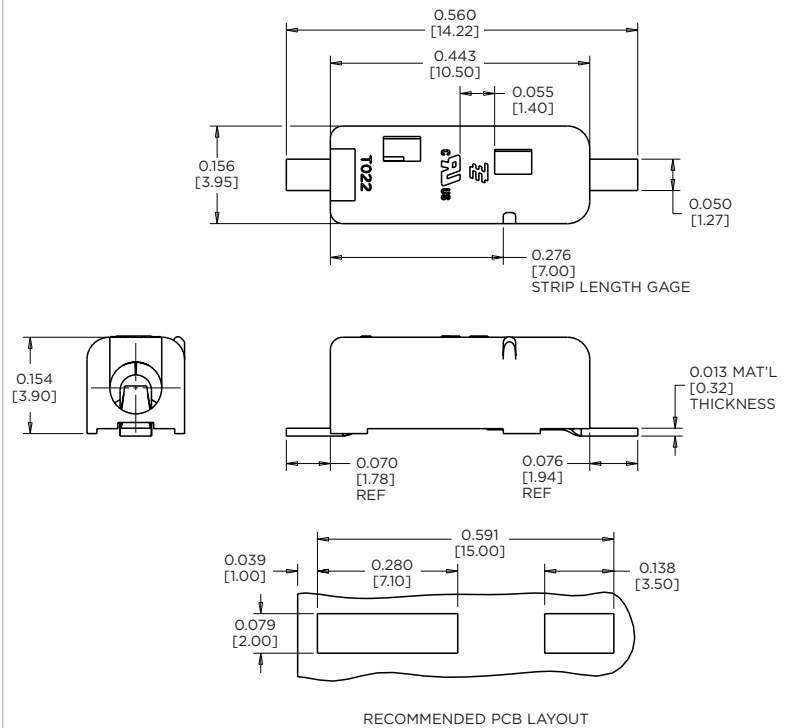

# SMT and Thru-Hole Poke-In Wire Lighting Connectors

## PRODUCT DIMENSIONS

**2 Position Thru-Hole**  
Part No. 2008106-1

**1 Position Thru-Hole**  
Part No. 2008839-1

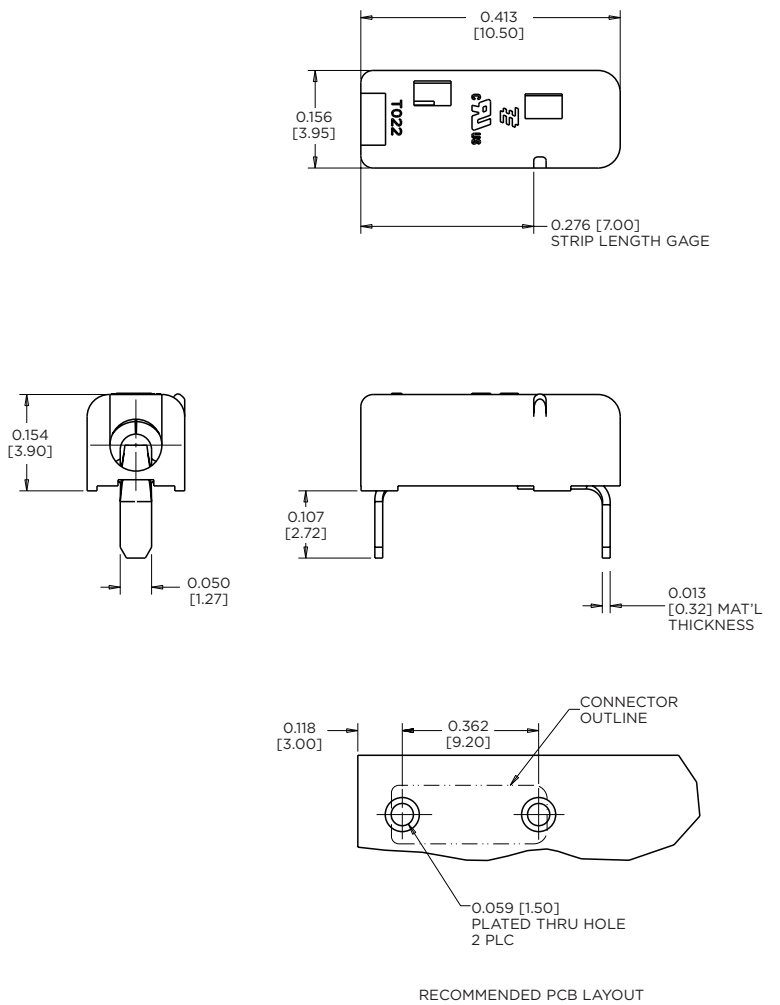
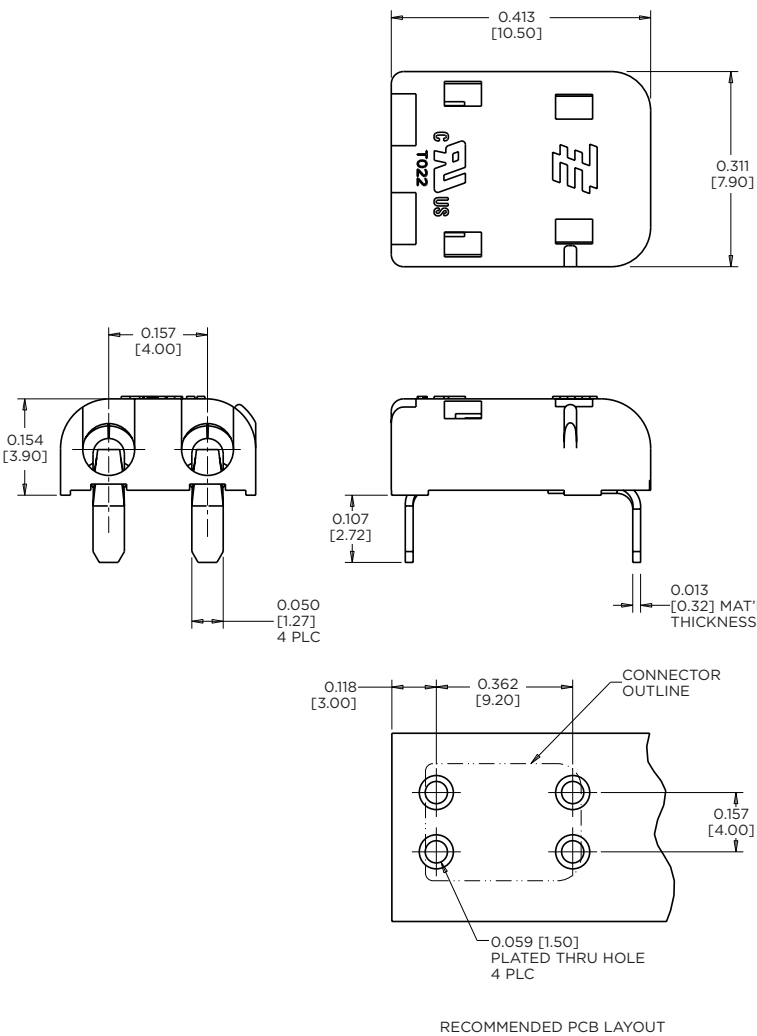

## FOR MORE INFORMATION

### Technical Support

Internet: [www.tycoelectronics.com](http://www.tycoelectronics.com)  
E-mail: [newproducts@tycoelectronics.com](mailto:newproducts@tycoelectronics.com)  
USA: 1-800-522-6752  
Canada: 1-905-470-4425  
Mexico: 1-800-733-8926  
C. America: 52-55-1106-0803  
South America: 55-11-2103-6000  
Hong Kong: 852-2735-1628  
Japan: 81-44-844-8013  
UK: 44-8706-080208

**Tyco Electronics Corporation**  
Harrisburg, PA

[tycoelectronics.com](http://tycoelectronics.com)

Copyright 2008 Tyco Electronics Corporation. All rights reserved.  
1773451-5- 5M -MS/FP - 7/2008.  
TE Logo and Tyco Electronics are trademarks.

 **Tyco Electronics**  
Our commitment. Your advantage.