

NOTES:

1. Material : Music Wire
2. Finish : Glod Irridite
3. Ends : Closed
4. Total Coils : 10.000
5. Sugg. Max. Deflection : 0.460 (in)
6. Sugg. Max. Load : 2.300 (lbs)
7. All Drawing Dimensions are in Inches [mm]

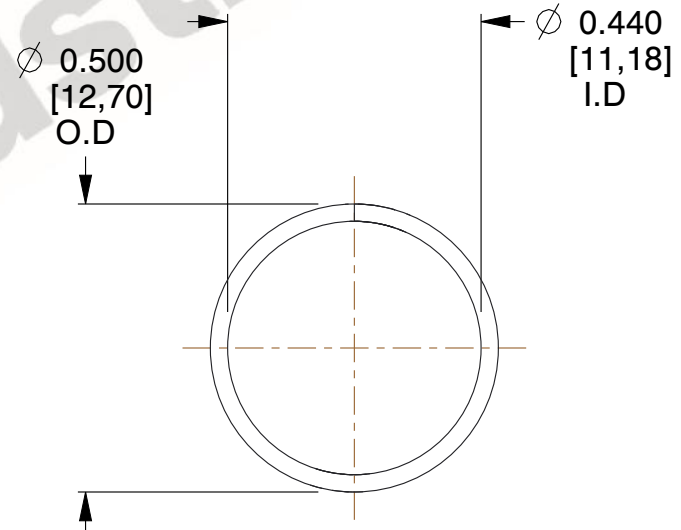
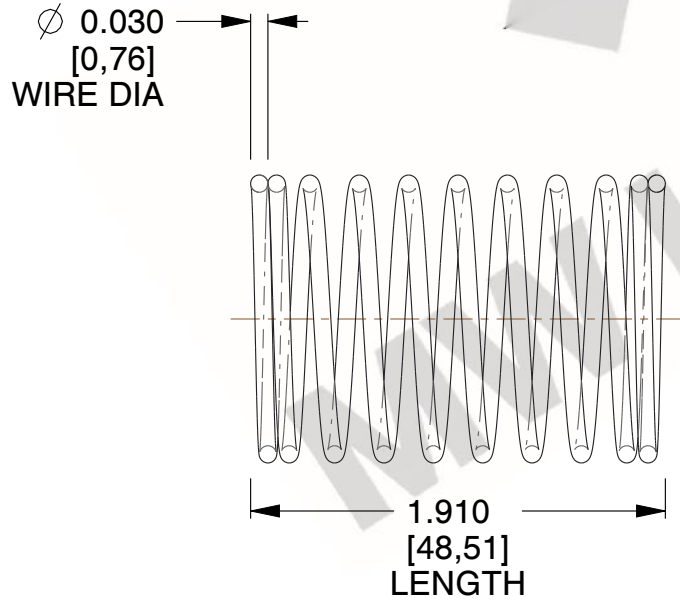
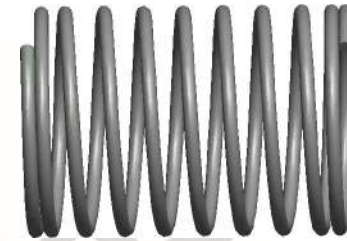

COMPONENT		SPRINGS	
11772 COMPRESSION SPRINGS		UNIT	INCH [mm]
		SHEET	1 of 1