

DATA SHEET

Part No.	AN41402A
Package Code No.	UBGA022-W-2030AEA

Contents

■ Overview	3
■ Features	3
■ Applications	3
■ Package	3
■ Type	3
■ Application Circuit Example (Block Diagram)	4
■ Pin Descriptions	5
■ Pin Configuration	5
■ Absolute Maximum Ratings	6
■ Operating Supply Voltage Range	6
■ Allowable Current and Voltage Range	7
■ Electrical Characteristics	8
■ Electrical Characteristics (Reference values for design)	9
■ Control Pin Mode Table	10
■ Technical Data	11
• I/O block circuit diagrams and pin function descriptions	11
• Reference data	13
• P_D — T_a diagram	14
■ Usage Notes	15
• Special attention and precaution in using	15
• Notes of Power LSI	16
• Notes of This LSI	17

AN41402A

2-ch Motor drive IC

■ Overview

The AN41402A is a 2-ch motor drive IC. This IC features a low ON resistance and wide operating supply voltage range. It is possible to shrink the mounting area by adopting the wafer level chip size package.

■ Features

- 2-ch motor drive IC
- Forward reverse drive is possible
- It is possible to drive not only a motor but also an actuator
- Low ON resistance : 0.4 Ω (Upper and Lower)
- Operating supply voltage range : 2.7 V to 5.5 V (for control circuit)
2.0 V to 13.8 V (for motor drive)
- Downsizing by adopting an Wafer Level Chip Size Package
- Additional features : Built-in Standby function
Thermal shutdown circuit
Low voltage detection circuit

■ Applications

- Shutter, Mirror and Lens for Camera

■ Package

- 19 pin Wafer Level Chip Size Package (WLCSP)
(Size : 2.41 mm \times 1.91 mm, 0.5 mm Pitch)

■ Type

- Bi-CDMOS IC

■ Application Circuit Example (Block Diagram)

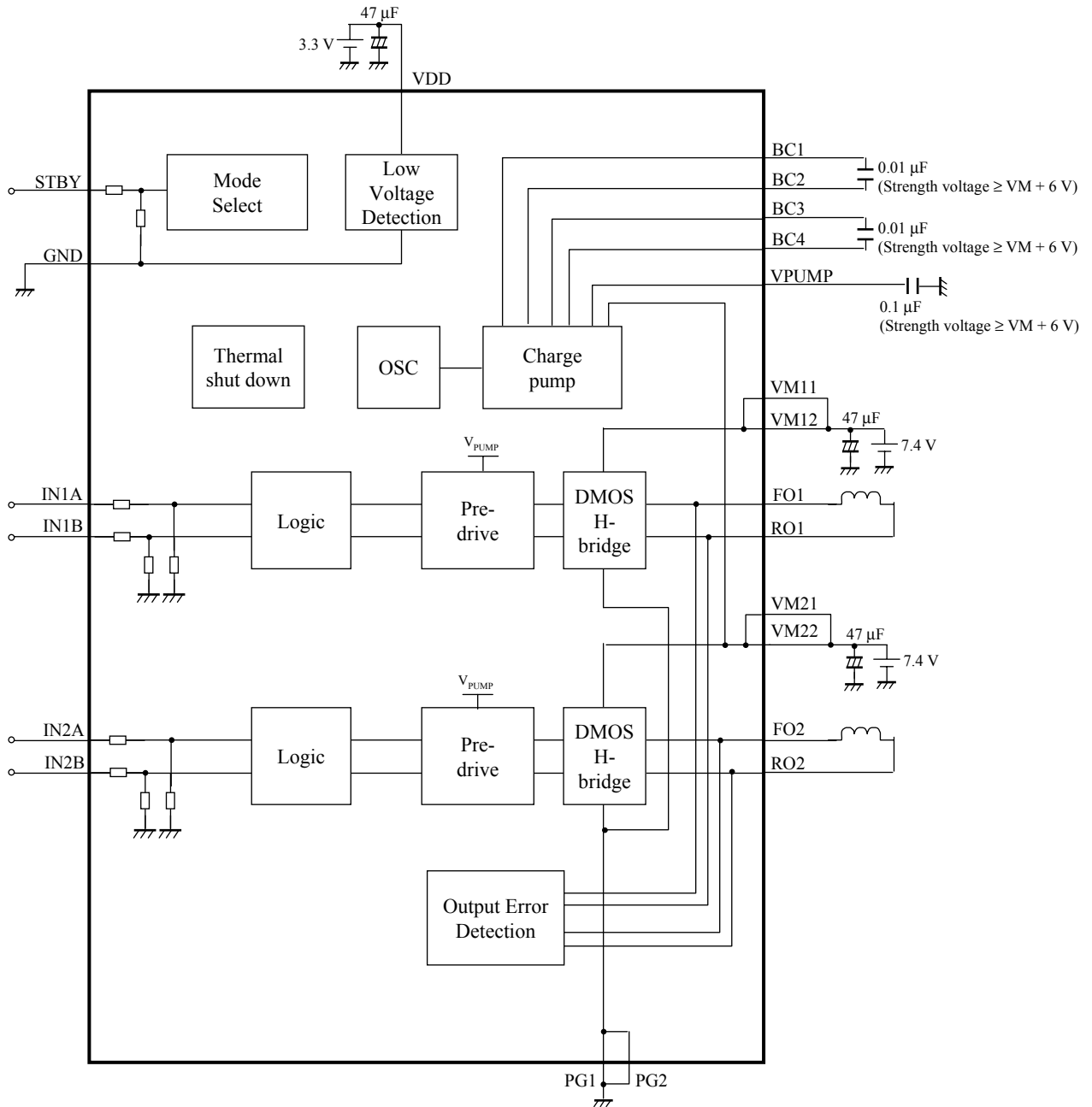

- Notes)
- This application circuit is an example. The operation of mass production set is not guaranteed. Perform enough evaluation and verification on the design of mass production set.
 - This block diagram is for explaining functions. Part of the block diagram may be omitted, or it may be simplified.

■ Pin Descriptions

Pin No.	Pin name	Type	Description
A1	GND	Ground	Ground for control circuit
A2	IN1A	Input	Ch.1 non-inverting input
A3	IN2A	Input	Ch.2 non-inverting input
A4	VM11	Power supply	Power supply 1 for Ch.1 motor drive
A5	RO1	Output	Ch.1 inverting output
A6	PG1	Ground	Ground 1 for motor drive
B1	STBY	Input	Total shutdown input
B2	IN1B	Input	Ch.1 inverting input
B3	IN2B	Input	Ch.2 inverting input
B4	VM12	Power supply	Power supply 2 for Ch.1 motor drive
B5	FO1	Output	Ch.1 non-inverting output
C1	VDD	Power supply	Power supply for control circuit
C2	BC4	Output	Charge pump capacitor connection 4
C3	BC2	Output	Charge pump capacitor connection 2
C4	VM21	Power supply	Power supply 1 for Ch.2 motor drive
C5	RO2	Output	Ch.2 inverting output
D1	VPUMP	Output	Charge pump output
D2	BC3	Output	Charge pump capacitor connection 3
D3	BC1	Output	Charge pump capacitor connection 1
D4	VM22	Power supply	Power supply 2 for Ch.2 motor drive
D5	FO2	Output	Ch.2 non-inverting output
D6	PG2	Ground	Ground 2 for motor drive

■ Pin Configuration (Bottom View)

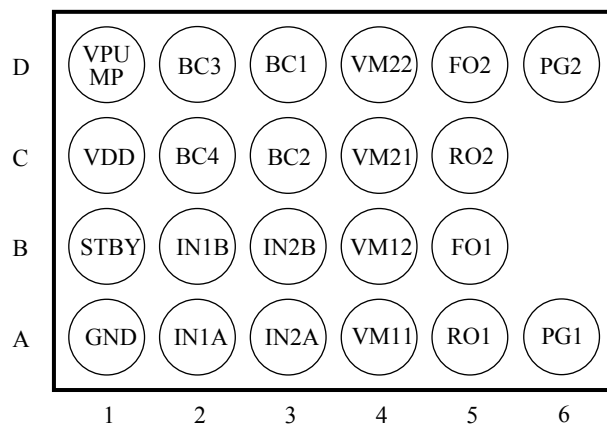

■ Absolute Maximum Ratings

Note) Absolute maximum ratings are limit values which do not result in damages to this IC, and IC operation is not guaranteed at these limit values.

A No.	Parameter	Symbol	Rating	Unit	Appropriate Pin No.	Notes
1	Supply voltage	V_{DD}	6.0	V	—	*1
		V_{M1}, V_{M2}	14.0			
2	Supply current	I_{DD}	100	mA	—	—
		I_{M1}	700			
		I_{M2}	700			
3	Power dissipation	P_D	100	mW	—	*2
4	Operating ambient temperature	T_{opr}	-30 to +85	°C	—	*3
5	Storage temperature	T_{stg}	-55 to +150	°C	—	*3
6	Drive output current	$I_{(p) DC}$	±700 (DC)	mA	p = A5, B5, C5, D5	*4 *5
		$I_{(p) peak1}$	±3 000 (1 ms)	mA		
		$I_{(p) peak2}$	±1 800 (10 ms)	mA		
		$I_{(p) peak3}$	±1 000 (100 ms)	mA		
7	Drive output voltage	$V_{(m)}$	14.7	V	m = A5, B5, C5, D5	*5
8	Control signal input voltage	$V_{(n)}$	GND to V_{DD}	V	n = A2, A3, B1, B2, B3	*5

Notes) *1: The values under the condition not exceeding the above absolute maximum ratings and the power dissipation.

The voltage of the charge pump circuit voltage will exceed the supply voltage. The limit voltage of the charge pump is shown on page 8.
 V_{M1} is voltage for VM11 and VM12. V_{M2} is voltage for VM21 and VM22.

*2: The power dissipation shown is the value at $T_a = 85^\circ\text{C}$ for the independent (unmounted) IC package without a heat sink.

When using this IC, refer to the $\bullet P_D-T_a$ diagram in the ■ Technical Data and design the heat radiation with sufficient margin so that the allowable value might not be exceeded based on the conditions of power supply voltage, load, and ambient temperature.

*3: Except for the power dissipation, operating ambient temperature, and storage temperature, all ratings are for $T_a = 25^\circ\text{C}$.

*4: Design the heat radiation with sufficient margin so that the allowable value might not be exceeded based on the time conditions which the drive output current ±3 000 mA is allowed within 1 ms and ±1 800 mA is allowed within 10 ms and ±1 000 mA is allowed within 100 ms. However, the output frequency f requires that $f \leq 5$ Hz.

*5: Do not apply voltage or current from outside to these pin. The setting not exceeding the rating, even transiently, is required.

For the circuit currents, '+' denotes current flowing into the IC, and '-' denotes current flowing out of the IC.

■ Operating Supply Voltage Range

Parameter	Symbol	Min	Typ	Max	Unit	Notes
Supply voltage range	V_{DD}	2.7	3.3	5.5	V	*1
	V_{M1}, V_{M2}	2.0	7.4	13.8		

Note) *1 : The values under the condition not exceeding the above absolute maximum ratings and the power dissipation.

■ Allowable Current and Voltage Range

- Notes)
- Allowable current and voltage ranges are limit ranges which do not result in damages to this IC, and IC operation is not guaranteed within these limit ranges.
 - Voltage values, unless otherwise specified, are with respect to GND. GND is voltage for GND, PG1 and PG2. GND = PG1 = PG2.
 - V_{DD} is voltage for VDD.
 - V_{M2} is voltage for VM21 and VM22. $V_{M2} = VM21 = VM22$.
 - Do not apply external currents or voltages to any pin not specifically mentioned.

Pin No.	Pin name	Rating	Unit	Notes
A2	IN1A	GND to V_{DD}	V	—
A3	IN2A	GND to V_{DD}	V	—
A5	RO1	-1.0 to 14.7	V	*1
B1	STBY	GND to V_{DD}	V	—
B2	IN1B	GND to V_{DD}	V	—
B3	IN2B	GND to V_{DD}	V	—
B5	FO1	-1.0 to 14.7	V	*1
C2	BC4	GND to 19.5	V	*1
C3	BC2	GND to 19.5	V	*1
C5	RO2	-1.0 to 14.7	V	*1
D1	VPUMP	GND to 18.5	V	*1
D2	BC3	GND to V_{M2}	V	*1
D3	BC1	GND to V_{M2}	V	*1
D5	FO2	-1.0 to 14.7	V	*1

Note) *1 : Do not apply external voltage to this pin. The setting not exceeding the rating, even transiently, is required.

■ Electrical Characteristics at $V_{DD} = 3.3\text{ V}$, $V_{M1} = V_{M2} = 7.4\text{ V}$, $STBY = 3.3\text{ V}$

Note) $T_a = 25^\circ\text{C} \pm 2^\circ\text{C}$ unless otherwise specified.

B No.	Parameter	Symbol	Conditions	Limits			Unit	Notes
				Min	Typ	Max		
Common Block								
Supply Current								
1	Drive power supply current in standby mode	I_{VM}	STBY = Low	—	—	100	μA	—
2	Control power supply current in standby mode	I_{DDS}	STBY = Low	—	—	10	μA	—
3	Control power supply current under no input	I_{DDA}	IN1A = IN1B = Low IN2A = IN2B = Low	—	1.7	2.2	mA	—
Standby Operation								
4	STBY High-level input voltage	V_{SBH}	—	2.2	—	—	V	*1
5	STBY Low-level input voltage	V_{SBL}	—	—	—	0.5	V	*1
6	STBY pull-down resistance	R_{STBY}	—	100	200	300	k Ω	—
Charge Pump Circuit								
7	Charge pump voltage	V_{PUMP}	$I_{PUMP} = 0\text{ A}$	11.4	12.4	13.4	V	—
8	Charge pump current capability	V_{PUMPL}	$I_{PUMP} = -500\ \mu\text{A}$	10.4	11.4	13.4	V	—
Driver Block								
9	IN1A, IN1B, IN2A, IN2B High-level input voltage	V_{INH}	—	2.2	—	—	V	*1
10	IN1A, IN1B, IN2A, IN2B Low-level input voltage	V_{INL}	—	—	—	0.5	V	*1
11	IN1A, IN1B, IN2A, IN2B High-level input current	I_{INH}	IN1A = IN1B = 3.3 V IN2A = IN2B = 3.3 V	8.3	16.5	33	μA	—
12	IN1A, IN1B, IN2A, IN2B Low-level input current	I_{INL}	—	-1.0	—	—	μA	—
13	Output ON resistance (Upper and Lower)	R_{ON}	$I_{VM1}, I_{VM2} = 500\text{ mA}$	—	0.4	0.5	Ω	—
14	Rise time	T_R	—	—	0.1	0.2	μs	—
15	Fall time	T_F	—	—	0.1	0.2	μs	—
16	Turn on time	T_{PLH}	—	—	0.4	1.0	μs	—
17	Turn off time	T_{PHL}	—	—	0.2	0.5	μs	—

Note) *1 :Refer to page 10 for the mode setting.

■ Electrical Characteristics (Reference values for design) at $V_{DD} = 3.3\text{ V}$, $V_{M1} = V_{M2} = 7.4\text{ V}$, $STBY = 3.3\text{ V}$

Notes) $T_a = 25^\circ\text{C} \pm 2^\circ\text{C}$ unless otherwise specified.

The characteristics listed below are reference values derived from the design of the IC and are not guaranteed by inspection.

If a problem does occur related to these characteristics, we will respond in good faith to user concerns.

B No.	Parameter	Symbol	Conditions	Reference values			Unit	Notes
				Min	Typ	Max		
18	Input signal frequency	f_{\max}	—	—	—	300	kHz	—
Operation of low voltage detection								
19	Operation voltage of low voltage detection	V_{LVD}	—	—	2.4	—	V	—
20	Hysteresis width	ΔV_{LVD}	—	—	0.2	—	V	—
Thermal shutdown								
21	Thermal shutdown operating temperature	T_{TSD}	—	—	160	—	$^\circ\text{C}$	—
22	Thermal shutdown hysteresis temperature	ΔT_{TSD}	—	—	35	—	$^\circ\text{C}$	—

■ Control Pin Mode Table

• Ch.1 motor drive

STBY	VDD	Temp.	Input Logic		Output state		Charge Pump Circuit	Mode
			IN1A	IN1B	FO1	RO1		
High	> 2.4 V	< 160°C	High	High	Low	Low	Active	Brake
			High	Low	High	Low		Normal rotation
			Low	High	Low	High		Reverse rotation
			Low	Low	Hi-Z	Hi-Z		Mute
	≤ 2.4 V	≥ 160°C	—	—	Hi-Z	Hi-Z		Low voltage detection
> 2.4 V	—		—	Hi-Z	Hi-Z	Thermal shutdown		
Low	—	—	—	—	—	Mute	Standby	

• Ch.2 motor drive

STBY	VDD	Temp.	Input Logic		Output state		Charge Pump Circuit	Mode
			IN2A	IN2B	FO2	RO2		
High	> 2.4 V	< 160°C	High	High	Low	Low	Active	Brake
			High	Low	High	Low		Normal rotation
			Low	High	Low	High		Reverse rotation
			Low	Low	Hi-Z	Hi-Z		Mute
	≤ 2.4 V	≥ 160°C	—	—	Hi-Z	Hi-Z		Low voltage detection
> 2.4 V	—		—	Hi-Z	Hi-Z	Thermal shutdown		
Low	—	—	—	—	—	Mute	Standby	

■ Technical Data

- I/O block circuit diagrams and pin function descriptions

Note) The characteristics listed below are reference values derived from the design of the IC and are not guaranteed.

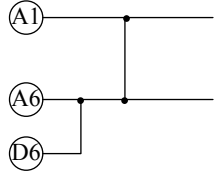
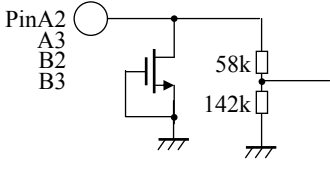
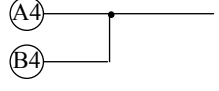
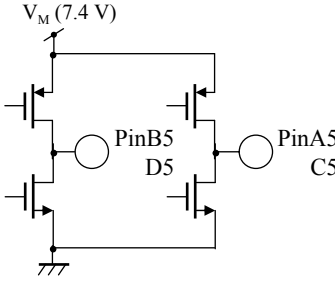
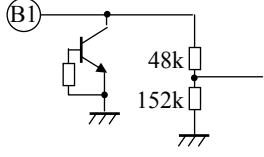
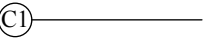
Pin No.	Waveform and voltage	Internal circuit	Impedance	Description
A1, A6, D6	DC 0 V		—	A1 : Ground for control circuit A6 : Ground 1 for motor drive D6 : Ground 2 for motor drive
A2, A3, B2, B3	—		200 kΩ	A2 : Ch.1 non-inverting input B2 : Ch.1 inverting input A3 : Ch.2 non-inverting input B3 : Ch.2 inverting input
A4, B4	DC (Typ. 7.4 V)		—	A4 : Power supply 1 for Ch.1 motor drive B4 : Power supply 2 for Ch.1 motor drive
A5, B5, C5, D5	—		—	B5 : Ch.1 non-inverting output A5 : Ch.1 inverting output D5 : Ch.2 non-inverting output C5 : Ch.2 inverting output
B1	—		200 kΩ	Total shutdown input
C1	DC (Typ. 3.3 V)		—	Power supply VDD for control circuit

■ Technical Data (continued)

- I/O block circuit diagrams and pin function descriptions (continued)

Note) The characteristics listed below are reference values derived from the design of the IC and are not guaranteed.

Pin No.	Waveform and voltage	Internal circuit	Impedance	Description
C2	—		—	Charge pump capacitor connection 4
C3	—		—	Charge pump capacitor connection 2
C4, D4	DC (Typ. 7.4 V)		—	C4 : Power supply 1 for Ch.2 motor drive D4 : Power supply 2 for Ch.2 motor drive
D1	DC About 12.4 V		—	Charge pump output
D2	—		—	Charge pump capacitor connection 3
D3	—		—	Charge pump capacitor connection 1

■ Technical Data (continued)

• Reference data

Note) The characteristics listed below are reference values derived from the design of the IC and are not guaranteed.

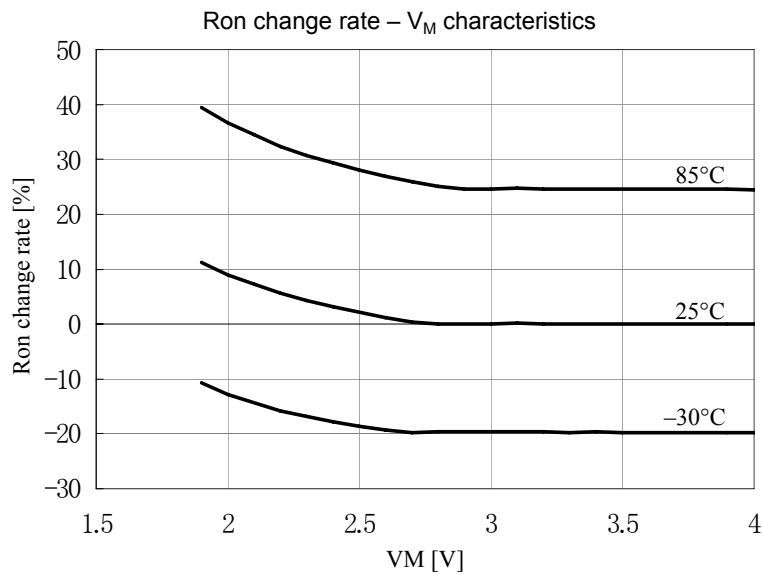
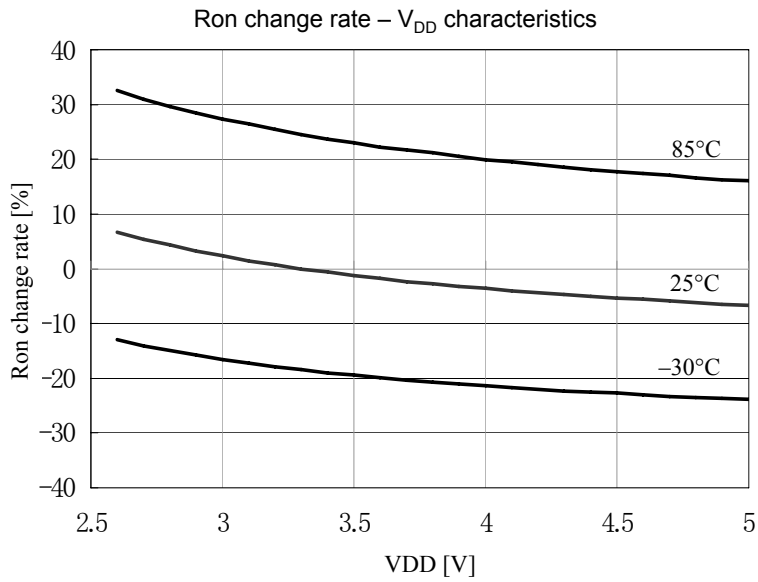

■ Technical Data (continued)

- $P_D - T_a$ diagram

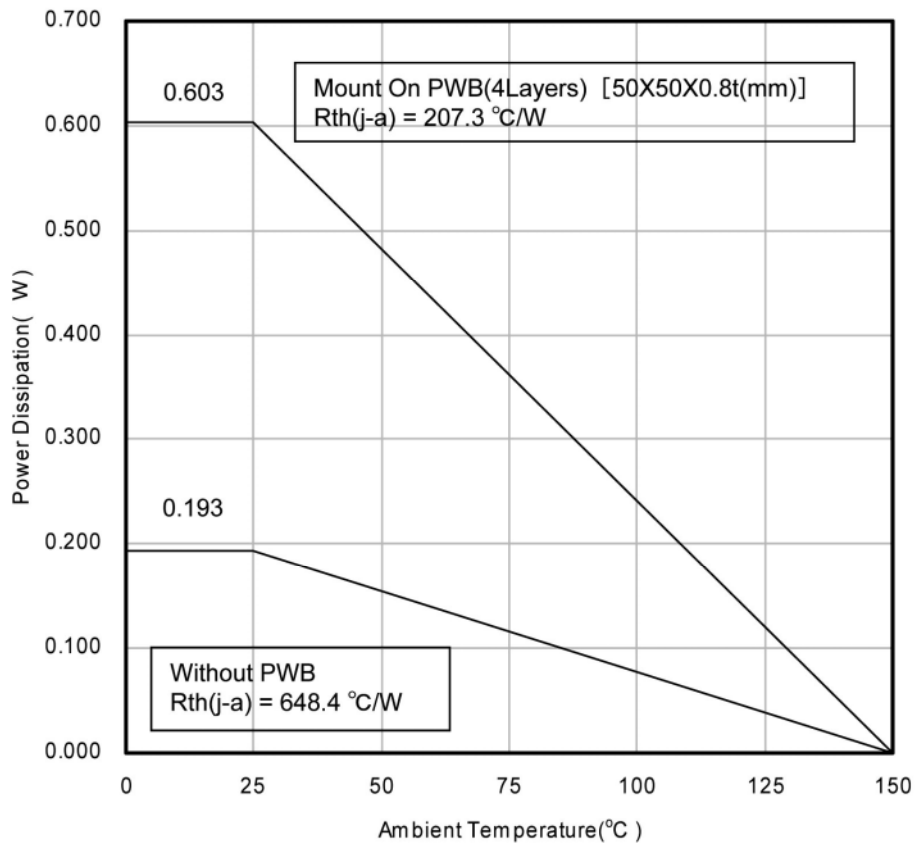

■ Usage Notes**• Special attention and precaution in using**

1. This IC is intended to be used for general electronic equipment [Shutter, Mirror and Lens for Camera].

Consult our sales staff in advance for information on the following applications:

- Special applications in which exceptional quality and reliability are required, or if the failure or malfunction of this IC may directly jeopardize life or harm the human body.
- Any applications other than the standard applications intended.
 - (1) Space appliance (such as artificial satellite, and rocket)
 - (2) Traffic control equipment (such as for automobile, airplane, train, and ship)
 - (3) Medical equipment for life support
 - (4) Submarine transponder
 - (5) Control equipment for power plant
 - (6) Disaster prevention and security device
 - (7) Weapon
 - (8) Others : Applications of which reliability equivalent to (1) to (7) is required

It is to be understood that our company shall not be held responsible for any damage incurred as a result of or in connection with your using the IC described in this book for any special application, unless our company agrees to your using the IC in this book for any special application.

2. Pay attention to the direction of LSI. When mounting it in the wrong direction onto the PCB (printed-circuit-board), it might smoke or ignite.
3. Pay attention in the PCB (printed-circuit-board) pattern layout in order to prevent damage due to short circuit between pins. In addition, refer to the Pin Description for the pin configuration.
4. Perform a visual inspection on the PCB before applying power, otherwise damage might happen due to problems such as a solder-bridge between the pins of the semiconductor device. Also, perform a full technical verification on the assembly quality, because the same damage possibly can happen due to conductive substances, such as solder ball, that adhere to the LSI during transportation.
5. Take notice in the use of this product that it might break or occasionally smoke when an abnormal state occurs such as output pin- V_{CC} short (Power supply fault), output pin-GND short (Ground fault), or output-to-output-pin short (load short) .
And, safety measures such as an installation of fuses are recommended because the extent of the above-mentioned damage and smoke emission will depend on the current capability of the power supply.
6. When designing your equipment, comply with the range of absolute maximum rating and the guaranteed operating conditions (operating power supply voltage and operating environment etc.). Especially, please be careful not to exceed the range of absolute maximum rating on the transient state, such as power-on, power-off and mode-switching. Otherwise, we will not be liable for any defect which may arise later in your equipment.
Even when the products are used within the guaranteed values, take into the consideration of incidence of break down and failure mode, possible to occur to semiconductor products. Measures on the systems such as redundant design, arresting the spread of fire or preventing glitch are recommended in order to prevent physical injury, fire, social damages, for example, by using the products.
7. When using the LSI for new models, verify the safety including the long-term reliability for each product.
8. When the application system is designed by using this LSI, be sure to confirm notes in this book.
Be sure to read the notes to descriptions and the usage notes in the book.
9. Due to unshielded structure of this IC, under exposure of light, function and characteristic of the product cannot be guaranteed.
During normal operation or even under testing condition, please ensure that IC is not exposed to light.
10. Basically, chip surface is ground potential. Please design to ensure no contact between chip surface and metal shielding.

■ Usage Notes (continued)

• Notes of Power LSI

1. The protection circuit is for maintaining safety against abnormal operation. Therefore, the protection circuit should not work during normal operation.
Especially for the thermal protection circuit, if the area of safe operation or the absolute maximum rating is momentarily exceeded due to output pin to V_{CC} short (Power supply fault), or output pin to GND short (Ground fault), the LSI might be damaged before the thermal protection circuit could operate.
2. Unless specified in the product specifications, make sure that negative voltage or excessive voltage are not applied to the pins because the device might be damaged, which could happen due to negative voltage or excessive voltage generated during the ON and OFF timing when the inductive load of a motor coil or actuator coils of optical pick-up is being driven.
3. The product which has specified ASO (Area of Safe Operation) should be operated in ASO.
4. Verify the risks which might be caused by the malfunctions of external components.

■ Usage Notes (continued)

• Notes of This LSI

1. Make sure to power on, off, and switching under the standby mode (STBY = Low).
2. Apply voltage from a low-impedance source to VDD and VM. Connect a bypass capacitor to each as near the IC as possible.
3. In case of that the output is changed into Hi-Z (IN1A = IN1B = Low, IN2A = IN2B = Low) in the rotation of motor, due to the motor current to flow back into a power source, the supply voltage might rise.
4. If the error detection circuit is active, all outputs are fixed in Hi-Z during the specified time (470 μs ±30%).
The function is for safety improvements and is not guaranteed nondestructive control.
5. Check the characteristics carefully before using this IC.
Preserve sufficient margin in consideration of dispersion of external components and our ICs including not only static characteristics but transition characteristics when using this IC changing external circuit constants.
6. Prohibit mounting with solder dipping and mounting to a flexible cable.
7. The heat thermal resistance is variable due to the mounted status of this IC. To reduce the heat thermal resistance, it is recommended that the power supply and GND pins are connected to a wide metal layer as short as possible.
Refer to the following figure shown an example of a wiring pattern.

<Reference value>

The heat thermal resistance value (for simulation) in case of the following wiring pattern example

$R_{th(j-a)} = 88 \text{ } ^\circ\text{C} / \text{W}$

Condition : Glass-epoxy PWB, 50 × 50 × 0.8t (mm), 4-ply

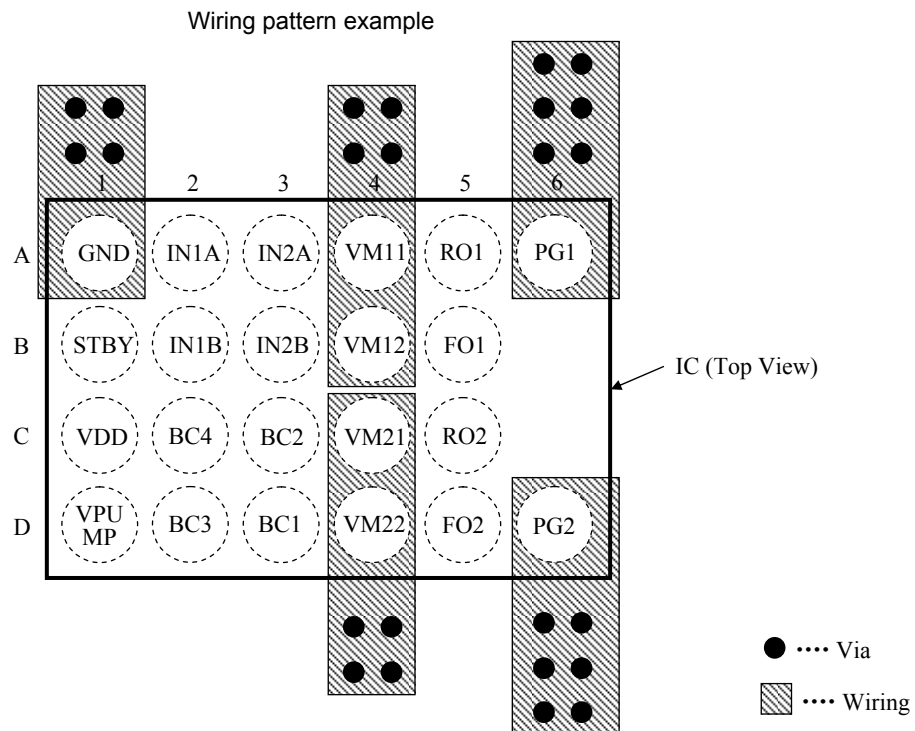

Request for your special attention and precautions in using the technical information and semiconductors described in this book

- (1) If any of the products or technical information described in this book is to be exported or provided to non-residents, the laws and regulations of the exporting country, especially, those with regard to security export control, must be observed.
- (2) The technical information described in this book is intended only to show the main characteristics and application circuit examples of the products. No license is granted in and to any intellectual property right or other right owned by Panasonic Corporation or any other company. Therefore, no responsibility is assumed by our company as to the infringement upon any such right owned by any other company which may arise as a result of the use of technical information described in this book.
- (3) The products described in this book are intended to be used for general applications (such as office equipment, communications equipment, measuring instruments and household appliances), or for specific applications as expressly stated in this book.
Consult our sales staff in advance for information on the following applications:
 - Special applications (such as for airplanes, aerospace, automotive equipment, traffic signaling equipment, combustion equipment, life support systems and safety devices) in which exceptional quality and reliability are required, or if the failure or malfunction of the products may directly jeopardize life or harm the human body.It is to be understood that our company shall not be held responsible for any damage incurred as a result of or in connection with your using the products described in this book for any special application, unless our company agrees to your using the products in this book for any special application.
- (4) The products and product specifications described in this book are subject to change without notice for modification and/or improvement. At the final stage of your design, purchasing, or use of the products, therefore, ask for the most up-to-date Product Standards in advance to make sure that the latest specifications satisfy your requirements.
- (5) When designing your equipment, comply with the range of absolute maximum rating and the guaranteed operating conditions (operating power supply voltage and operating environment etc.). Especially, please be careful not to exceed the range of absolute maximum rating on the transient state, such as power-on, power-off and mode-switching. Otherwise, we will not be liable for any defect which may arise later in your equipment.
Even when the products are used within the guaranteed values, take into the consideration of incidence of break down and failure mode, possible to occur to semiconductor products. Measures on the systems such as redundant design, arresting the spread of fire or preventing glitch are recommended in order to prevent physical injury, fire, social damages, for example, by using the products.
- (6) Comply with the instructions for use in order to prevent breakdown and characteristics change due to external factors (ESD, EOS, thermal stress and mechanical stress) at the time of handling, mounting or at customer's process. When using products for which damp-proof packing is required, satisfy the conditions, such as shelf life and the elapsed time since first opening the packages.
- (7) This book may be not reprinted or reproduced whether wholly or partially, without the prior written permission of our company.