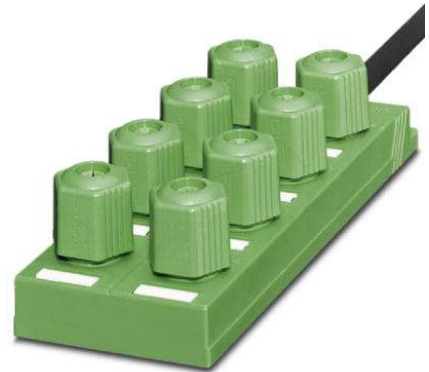

SACB-8Q/4P- 5,0PUR

Order No.: 1683701

<http://eshop.phoenixcontact.de/phoenix/treeViewClick.do?UID=1683701>

Sensor/actuator box, QUICKON, 0.34 mm² ... 0.75 mm², Number of slots: 8, Number of positions: 4, Slot assignment: Single, Status indication: No, Universal 180°, PUR/PVC, Cable length: 5 m, Shielding: No

Commercial data

GTIN (EAN)	
sales group	D104
Pack	1 pcs.
Customs tariff	85366990
Catalog page information	Page 119 (PC-2009)

Product notes

WEEE/RoHS-compliant since:
02/09/2006



<http://www.download.phoenixcontact.com>
Please note that the data given here has been taken from the online catalog. For comprehensive information and data, please refer to the user documentation. The General Terms and Conditions of Use apply to Internet downloads.

Technical data

General data

Rated voltage	120 V
Max. operating voltage U _{max}	135 V
Current carrying capacity per I/O signal	4 A

Current carrying capacity per slot	4 A
Total rated current	12 A
Number of positions	4
Number of slots	8
Degree of protection	IP65/IP67
Inflammability class acc. to UL 94	V0
Ambient temperature (operation)	-25 °C ... 60 °C
Sensor/actuator connection system	QUICKON

Master cable data

Type of connection	Fixed connection
Length of cable	5 m
Cable type	Master cable suitable for flexible cable conduit
Signal line cross section	8x 0.34 mm ²
AWG signal line	22
Conductor structure signal line	42x 0.10 mm
Power supply cross section	3x 0.75 mm ²
AWG power supply	18
Conductor structure, voltage supply	96x 0.10 mm
External diameter	9.2 mm
Max. bending cycles	1500000
Bending radius	95 mm
Traversing path	2 m
Traversing rate	2 m/s
Ambient temperature (operation)	-40 °C ... 90 °C (for fixed installation) -5 °C ... 80 °C (for flexible installation)

Conductor data

Structure of individual litz in acc. with VDE 0295 / smallest wire diameter	Class 2-6 // 0.34 mm ² : 0.1 mm; 0.5 - 0.75 mm ² : 0.15 mm
Wire insulation material	PVC/PE
Wire diameter including insulation	≤ 2.5 mm
Minimum external conductor diameter	4 mm
Maximum external conductor diameter	7.5 mm
Tightening torque, union nut	2.5 Nm
Wrench size, union nut	22 mm

Note on the frequency of connections	if the conductor is connected more than once, seal and cap may need to be replaced.
Conductor cross section stranded max.	0.75 mm ²
Conductor cross section stranded min.	0.34 mm ²
Conductor cross section AWG/kcmil min.	22
Conductor cross section AWG/kcmil max	18

Insulation material

Housing material	PA
Material of the moulding mass	PUR
Contact material	Steel/copper
Contact surface material	Sn

Pin assignment

Slot/position = Wire color or connection	1 / 4 (A) = WH
	2 / 4 (A) = GN
	3 / 4 (A) = YE
	4 / 4 (A) = GY
	5 / 4 (A) = PK
	6 / 4 (A) = RD
	7 / 4 (A) = BK
	8 / 4 (A) = VT
	1-8 / 1 (+ 120 V) = BN
	1-8 / 3 (0 V) = BU
	1-8 / 5 (PE) = GN/YE

Certificates / Approvals



Certification

CUL, GOST, UL

Accessories

Item	Designation	Description
------	-------------	-------------

Assembly

1670743	Q SET-11/4 COD1 SACB-Q	QUICKON set for replacement purposes, consisting of pressure nut, cap, line seal and splice ring
---------	------------------------	--

Marking

2809128	ZBN 18:UNBEDRUCKT	Unprinted marker labels, strips with 5 labels for individual labeling with M-PEN or CMS system, for terminal block width: 17.5 mm, color: White
---------	-------------------	---

Protection and sealing elements

1670235	Q-PROT 9/11	Closing cap for PG9/PG11 to close unoccupied connections
---------	-------------	--

Tools

1670206	QSS 22	Allen wrench, for loosening and fastening the QUICKON union nut, WAF 22 mm
---------	--------	--

Diagrams/Drawings

Dimensioned drawing

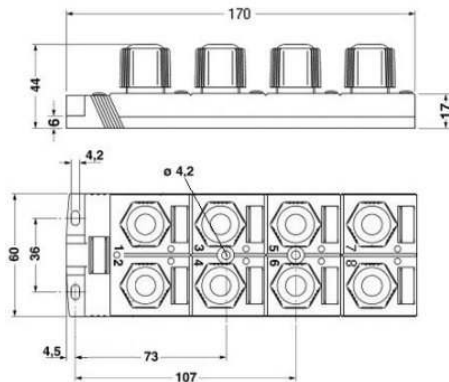

Circuit diagram

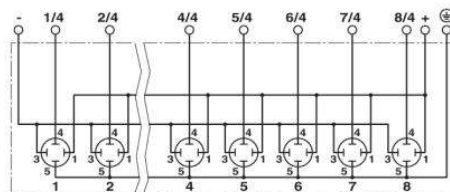

Schematic diagram

QUICKON connection, 4-pos.

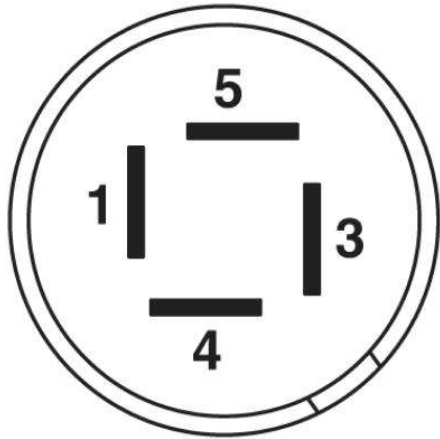

Address

PHOENIX CONTACT Inc., USA
586 Fulling Mill Road
Middletown, PA 17057, USA
Phone (800) 888-7388
Fax (717) 944-1625
<http://www.phoenixcon.com>



© 2010 Phoenix Contact
Technical modifications reserved;