

Part Number: APBA3210SURKCGKC-F01

Hyper Red  
Green

### Features

- 3.2mmx1.0mm right angle SMT LED, 1.5mm thickness.
- Low power consumption.
- Wide viewing angle.
- Package : 2000pcs / reel.
- Moisture sensitivity level : level 3.
- RoHs compliant.

### Description

The Hyper Red source color devices are made with Al-GaN on GaAs substrate Light Emitting Diode.  
The Green source color devices are made with AlGaInP on GaAs substrate Light Emitting Diode.

### Package Dimensions

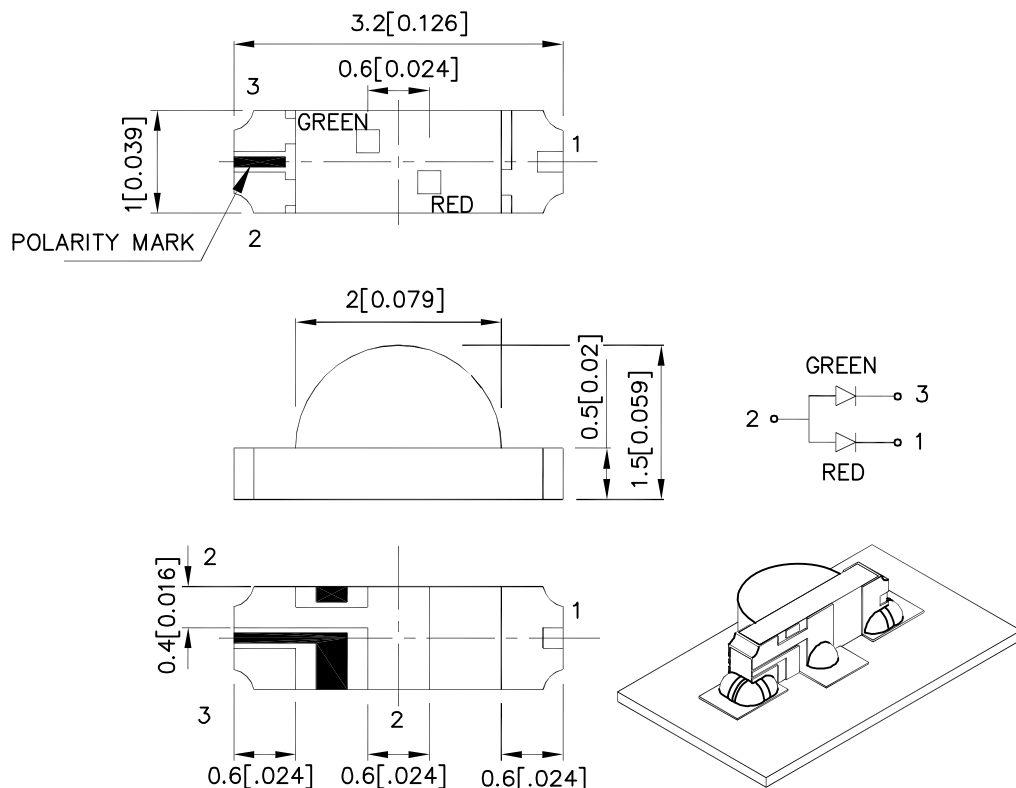

Notes:

1. All dimensions are in millimeters (inches).
2. Tolerance is  $\pm 0.1(0.004)$  unless otherwise noted.
3. Specifications are subject to change without notice.
4. The device has a single mounting surface. The device must be mounted according to the specifications.



## Selection Guide

Part No.	Dice	Lens Type	Iv (mcd) [2] @ 20mA		Viewing Angle [1]
			Min.	Typ.	2θ1/2
APBA3210SURKCGKC-F01	Hyper Red (AlGaInP)	WATER CLEAR	110	200	120°
	Green (AlGaInP)		18	50	

Notes:

1. θ1/2 is the angle from optical centerline where the luminous intensity is 1/2 the optical centerline value.
2. Luminous intensity/ luminous Flux: +/-15%.

## Electrical / Optical Characteristics at TA=25°C

Symbol	Parameter	Device	Typ.	Max.	Units	Test Conditions
λpeak	Peak Wavelength	Hyper Red Green	650 574		nm	IF=20mA
λD [1]	Dominant Wavelength	Hyper Red Green	630 570		nm	IF=20mA
Δλ1/2	Spectral Line Half-width	Hyper Red Green	28 20		nm	IF=20mA
C	Capacitance	Hyper Red Green	35 15		pF	VF=0V;f=1MHz
VF [2]	Forward Voltage	Hyper Red Green	1.95 2.1	2.5 2.5	V	IF=20mA
IR	Reverse Current	Hyper Red Green		10 10	uA	VR = 5V

Notes:

1. Wavelength: +/-1nm.
2. Forward Voltage: +/-0.1V.

## Absolute Maximum Ratings at TA=25°C

Parameter	Hyper Red	Green	Units
Power dissipation	75	75	mW
DC Forward Current	30	30	mA
Peak Forward Current [1]	185	150	mA
Reverse Voltage	5		V
Operating Temperature	-40°C To +85°C		
Storage Temperature	-40°C To +85°C		

Note:

1. 1/10 Duty Cycle, 0.1ms Pulse Width.

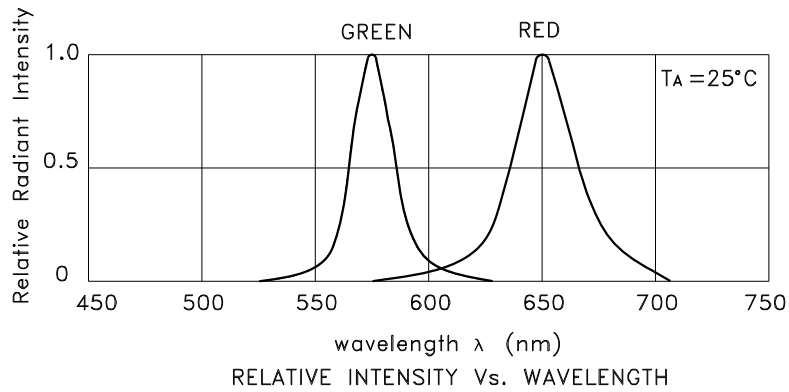

## APBA3210SURKCGKC-F01 Hyper Red

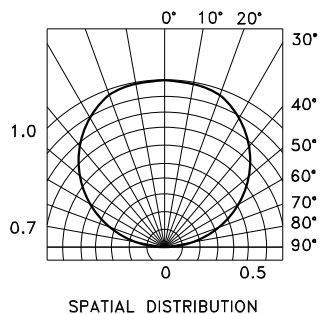
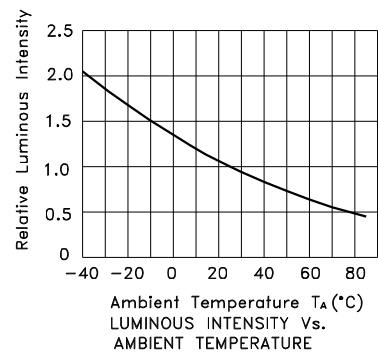
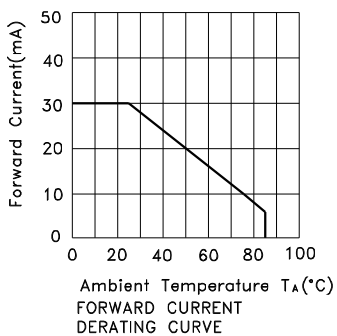
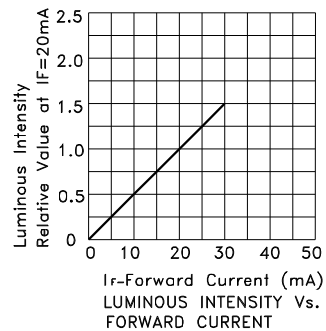
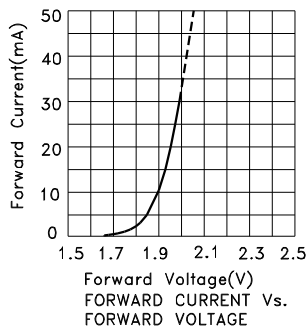

# Kingbright

## Green

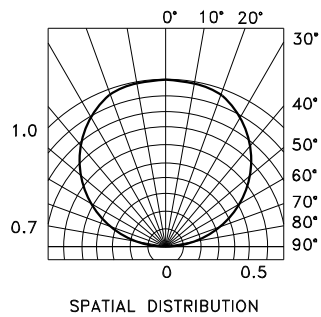
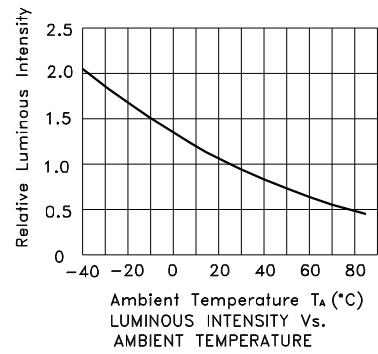
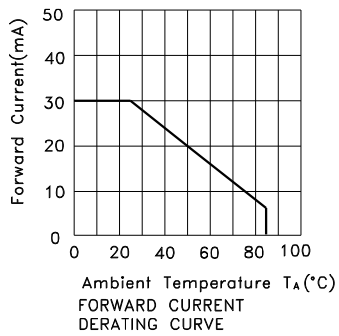
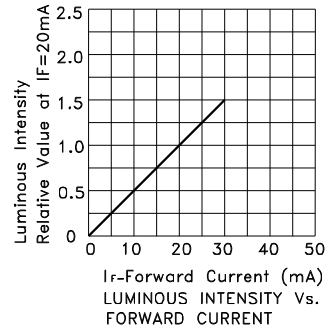
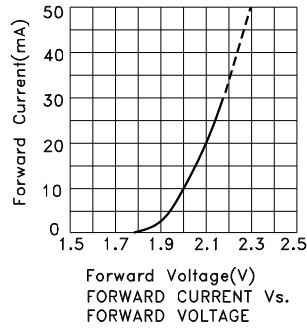





# Kingbright

## PACKING & LABEL SPECIFICATIONS

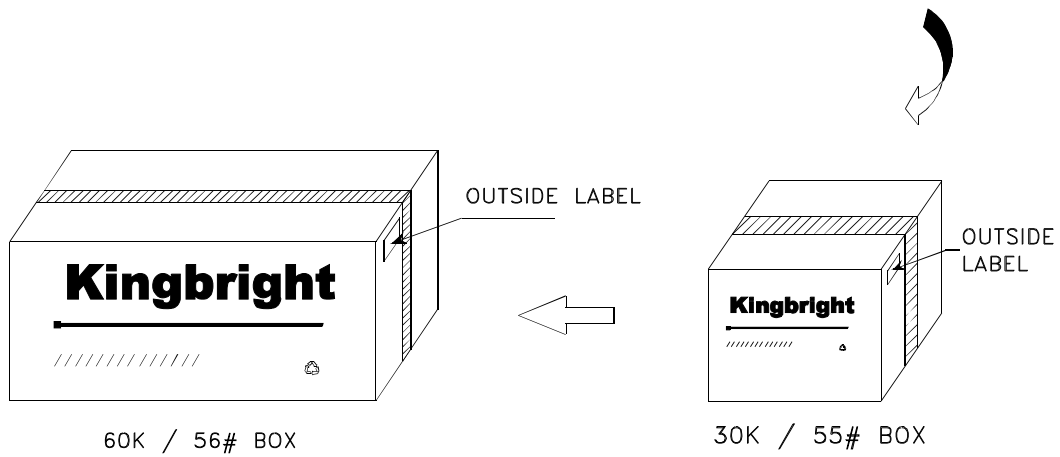
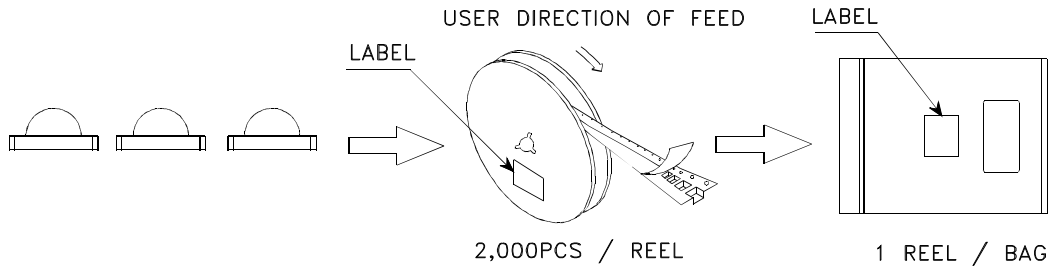
APBA3210SURKCGKC-F01



<h1>Kingbright</h1>	
P/NO: APBA3210xxx	
QTY: 2,000 pcs	Q.C. <span style="border: 1px solid black; border-radius: 50%; padding: 2px;">Q C XX XX XXXX PASSED</span>
S/N: XXXX	
CODE: XXX	
LOT NO:	
 xxxxxxxxxxxxxxxxxxxxxxxxxxxxxxxx	
RoHS Compliant	