

### 1. Features

- Bi-directional
- Protection for the IEC61000-4-2(ESD)  $\pm 15\text{kV}$ (air),  $\pm 15\text{kV}$ (contact)
- Ultra low capacitance (0.05pF)
- No distortion
- RoHS regulation conformity parts

### 2. Mechanical details

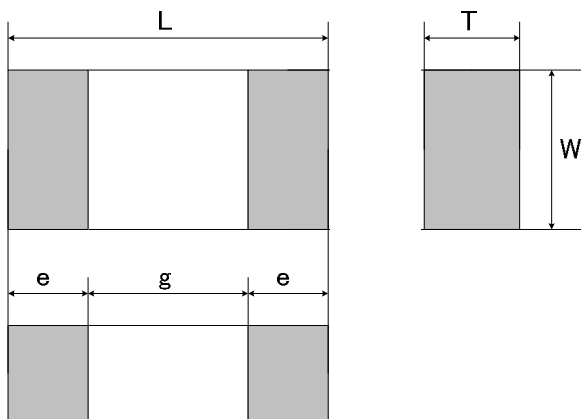

(unit : mm)

Mark	Dimension
L	1.00 $\pm$ 0.05
W	0.50 $\pm$ 0.05
T	0.33 max
e	0.20 $\pm$ 0.10
g	0.40 min

### 3. Schematic

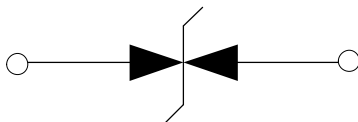

### 4. Maximum Ratings

Parameter	Ratings	Units
Operating Voltage	15	V
ESD per IEC 61000-4-2 (air) ESD per IEC 61000-4-2 (contact)	$\pm 15$	kV
Operating Temperature	-40 to +85	$^{\circ}\text{C}$
Storage Temperature	-40 to +85	$^{\circ}\text{C}$

### 5. Electrical Characteristics (T=25 °C)

Parameter	Conditions	Min	Typ	Max	Units
Capacitance	Vbias=0V, 1MHz		0.05		pF

### 6. Typical Characteristic

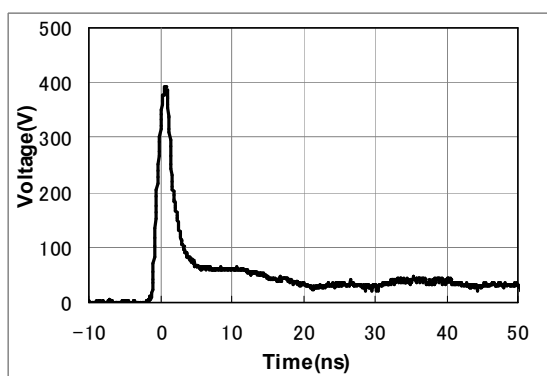

ESD Waveform (IEC61000-4-2:8kV Contact)

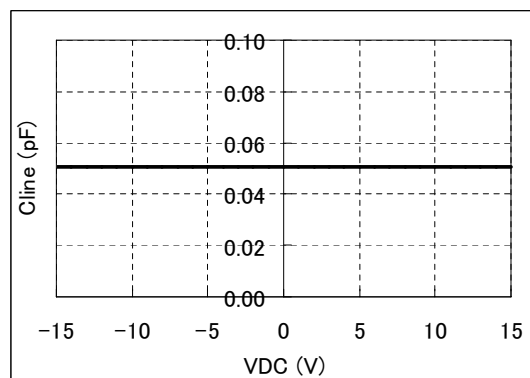

Voltage – Capacitance Characteristic

### 7. Soldering Footprint

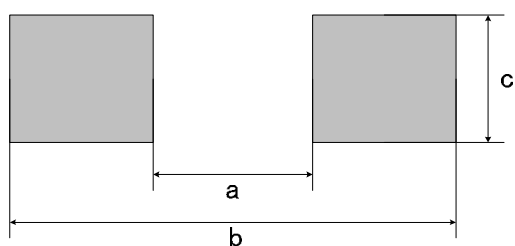

(unit : mm)

Mark	Dimension
a	0.4
b	1.2
c	0.5

Notes : this land layout is for reference purpose only.

### 9. Taping Specification

#### 1) Dimensions of Tape (Paper tape) (in mm)

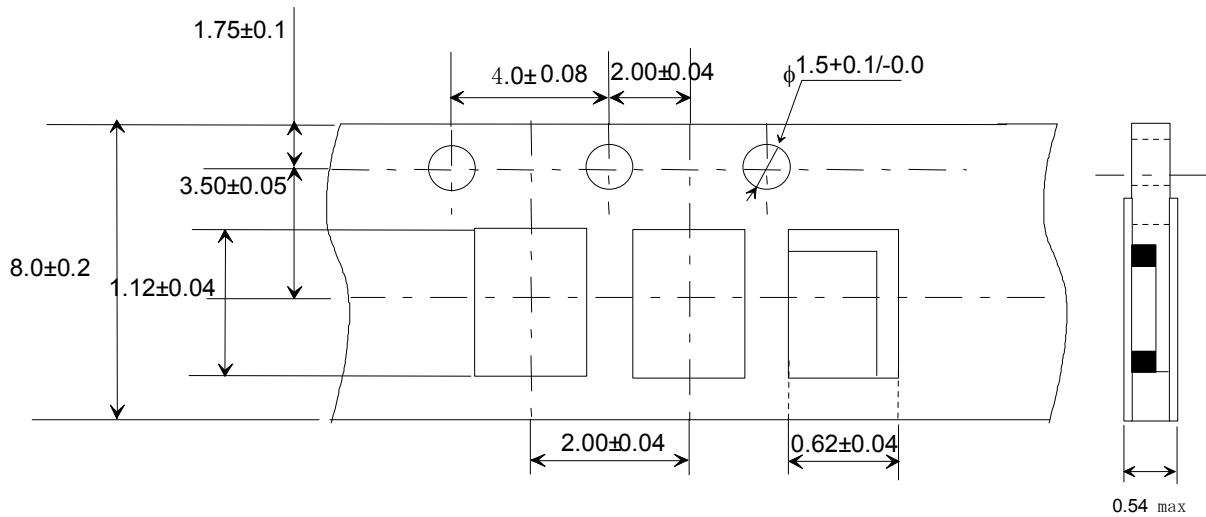

#### 2) Dimensions of Reel (in mm)

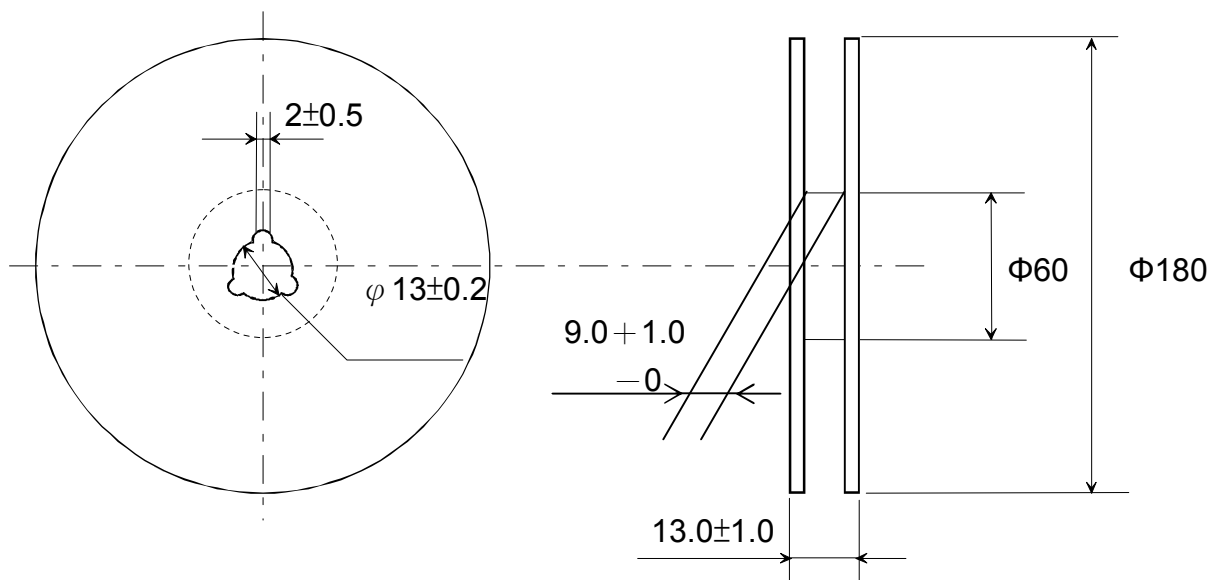

#### 3) Packaging unit: 10,000 pcs / reel

**Note:**

1. This datasheet's specifications are subject to change or our products in it may be discontinued without advance notice. Please check with our sales representatives or product engineers before ordering.
2. This datasheet has only typical specifications because there is no space for detailed specifications. Therefore, please approve our product specifications or transact the approval sheet for product specifications before ordering.