

CGHV96050F1

50 W, 7.9 - 9.6 GHz, 50-ohm, Input/Output Matched GaN HEMT

Description

WolfSpeed's CGHV96050F1 is a gallium nitride (GaN) High Electron Mobility Transistor (HEMT) on Silicon Carbide (SiC) substrates. This GaN Internally Matched (IM) FET offers excellent power added efficiency in comparison to other technologies. GaN has superior properties compared to silicon or gallium arsenide, including higher breakdown voltage, higher saturated electron drift velocity and higher thermal conductivity. GaN HEMTs also offer greater power density and wider bandwidths compared to GaAs transistors. This IM FET is available in a metal/ceramic flanged package for optimal electrical and thermal performance.

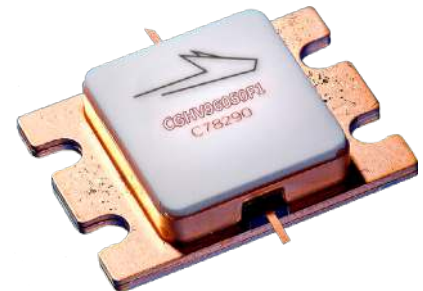

PN: CGHV96050F1
Package Type: 440217

Features

- 7.9 - 8.4 GHz Operation
- 80 W P_{OUT} typical
- >13 dB Power Gain
- 33% Typical PAE
- 50 Ohm Internally Matched
- <0.1 dB Power Droop

Applications

- Satellite Communications
- Terrestrial Broadband

Typical Performance Over 7.9 - 8.4 GHz (T_C = 25°C)

Parameter	7.9 GHz	8.0 GHz	8.1 GHz	8.2 GHz	8.3 GHz	8.4 GHz	Units
Linear Gain	17.0	16.7	16.4	15.9	15.2	14.6	dB
Output Power	22.4	28.2	28.2	31.6	31.6	31.6	W
Power Gain	15.6	15.0	15.1	14.5	14.0	13.2	dB
Power Added Efficiency	30	37	37	39	38	37	%

Notes:

¹ Measured at -30 dBc, 1.6 MHz from carrier, in the CGHV96050F1-AMP (838176) under OQPSK modulation, 1.6 Msps, PN23, Alpha Filter = 0.2

 Large Signal Models Available for ADS and MWO





Absolute Maximum Ratings (not simultaneous)

Parameter	Symbol	Rating	Units	Conditions
Drain-Source Voltage	V_{DSS}	100	V	25°C
Gate-to-Source Voltage	V_{GS}	-10, +2		
Power Dissipation	P_{DISS}	57.6 / 86.4	W	(CW / Pulse)
Storage Temperature	T_{STG}	-65, +150	°C	
Operating Junction Temperature	T_J	225		
Maximum Drain Current ¹	I_{DMAX}	6	A	
Maximum Forward Gate Current	I_{GMAX}	14.4	mA	25°C
Soldering Temperature ²	T_S	245	°C	
Screw Torque	τ	40	in-oz	
Thermal Resistance, Junction to Case	$R_{\theta JC}$	1.26	°C/W	Pulse Width = 100µs, Duty Cycle = 10%, $P_{DISS} = 86.4$ W
Thermal Resistance, Junction to Case		2.16		CW, 85°C, $P_{DISS} = 57.6$ W
Case Operating Temperature ³	T_C	-40, +150	°C	

Notes:

¹ Current limit for long term, reliable operation

² Refer to the Application Note on soldering at wolfspeed.com/rf/document-library

³ See also, Power Dissipation Derating Curve on page 10

Electrical Characteristics (Frequency = 7.9 - 8.4 GHz unless otherwise stated; $T_C = 25^\circ\text{C}$)

Characteristics	Symbol	Min.	Typ.	Max.	Units	Conditions
DC Characteristics¹						
Gate Threshold Voltage	$V_{GS(th)}$	-3.8	-3.0	-2.3	V	$V_{DS} = 10$ V, $I_D = 14.4$ mA
Gate Quiescent Voltage	$V_{GS(Q)}$	—		—		$V_{DS} = 40$ V, $I_D = 500$ mA
Saturated Drain Current ²	I_{DS}	11.5	13.0	—	A	$V_{DS} = 6.0$ V, $V_{GS} = 2.0$ V
Drain-Source Breakdown Voltage	V_{BR}	100	—	—	V	$V_{GS} = -8$ V, $I_D = 14.4$ mA
RF Characteristics³						
Small Signal Gain	S21	13.25	16	—	dB	$V_{DD} = 40$ V, $I_{DQ} = 500$ mA, $P_{IN} = 20$ dBm
Input Return Loss	S11	—	-4.9	-3.0		
Output Return Loss	S22	—	-10.7	-5.5		
Power Gain ^{3,4} at 7.9 GHz	G_P	10.75	15.6	—	%	$V_{DD} = 40$ V, $I_{DQ} = 500$ mA, $P_{OUT} = 44$ dBm
Power Gain ^{3,4} at 8.4 GHz			13.5	—		
Power Added Efficiency ^{3,4} at 7.9 GHz	PAE	18	25	—		
Power Added Efficiency ^{3,4} at 8.4 GHz			27	—		
OQPSK Linearity ^{3,4} at 7.9 GHz	ACLR	—	—	-26	dBc	No damage at all phase angles, $V_{DD} = 40$ V, $I_{DQ} = 500$ mA
OQPSK Linearity ^{3,4} at 8.4 GHz		—	—			
Output Mismatch Stress	VSWR	—	—	5 : 1	Ψ	

Notes:

¹ Measured on wafer prior to packaging

² Scaled from PCM data

³ Measured at -30 dBc, 1.6 MHz from carrier, in the CGHV96050F1-AMP (838176) under OQPSK modulation, 1.6 Msps, PN23, Alpha Filter = 0.2

⁴ Fixture loss de-embedded using the following offsets: At 7.9 GHz, input and output = 0.45 dB. At 8.4 GHz, input = 0.50 dB and output = 0.55 dB.



CGHV96050F1 Typical Performance

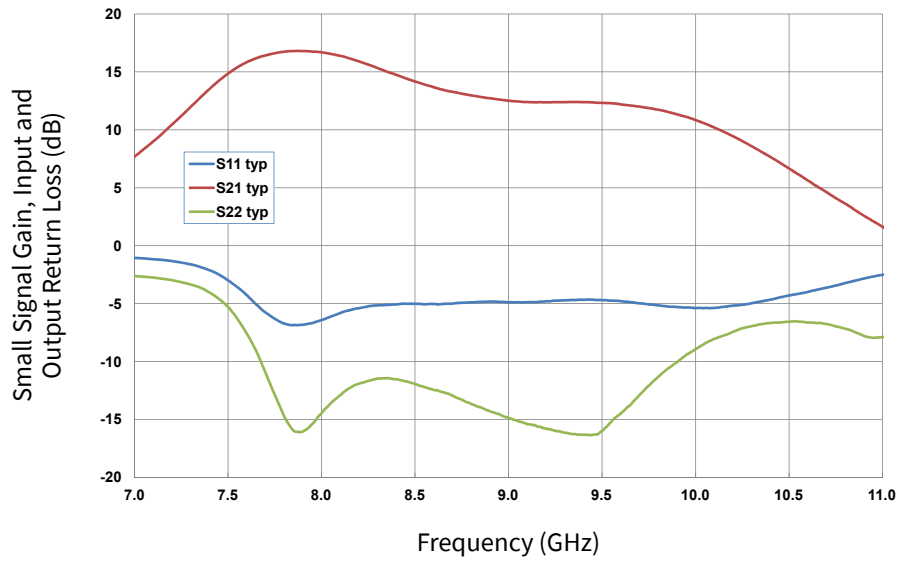

Figure 1. Small Signal Gain and Return Loss vs Frequency of CGHV96050F1 measured in CGHV96050F1-AMP
 $V_{DS} = 40\text{ V}$, $I_{DQ} = 500\text{ mA}$

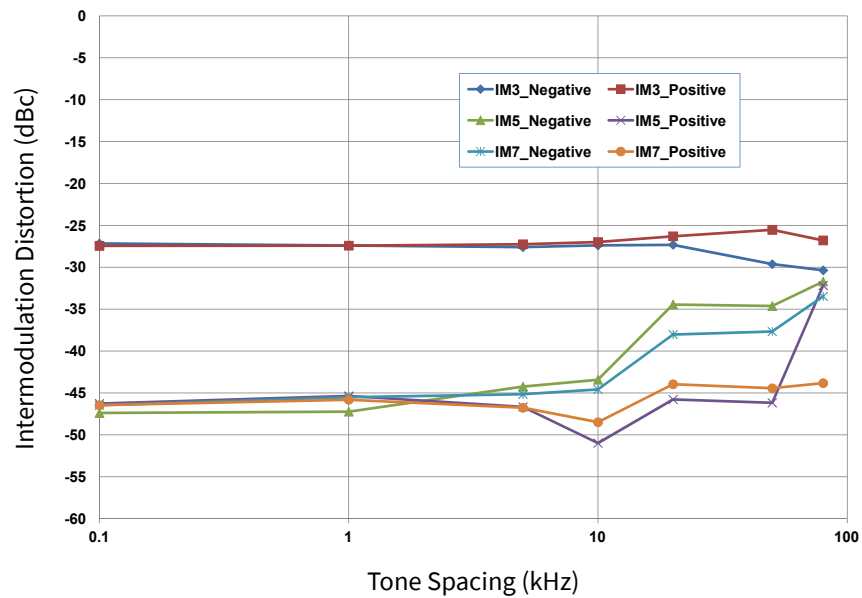

Figure 2. Intermodulation Distortion Performance vs Tone Spacing
 $V_{DD} = 40\text{ V}$, $f = 8.2\text{ GHz}$, Output Power = 44 dBm / 20 W



CGHV96050F1 Typical Performance

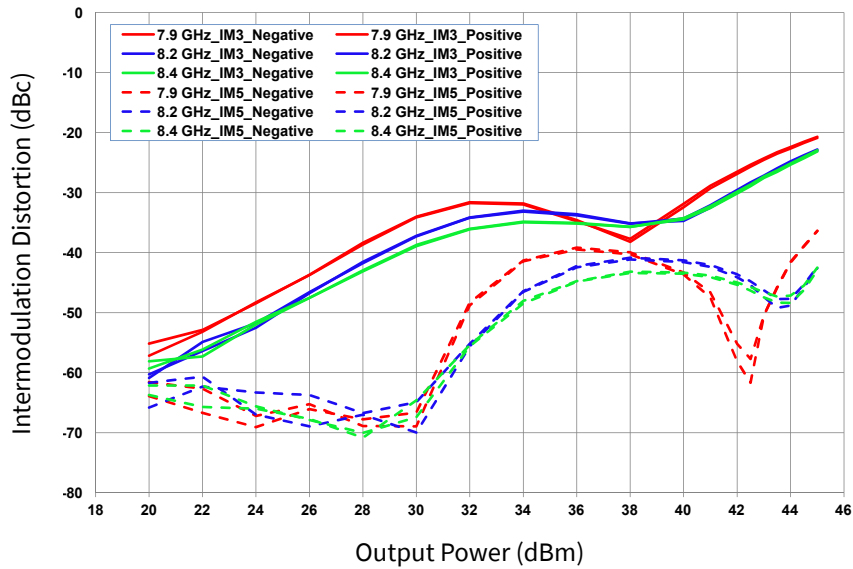

Figure 3. IM3 and IM5 vs Output Power at 7.9 GHz, 8.2 GHz, and 8.4 GHz
 $V_{DD} = 40\text{ V}$, Tone Spacing = 100 kHz

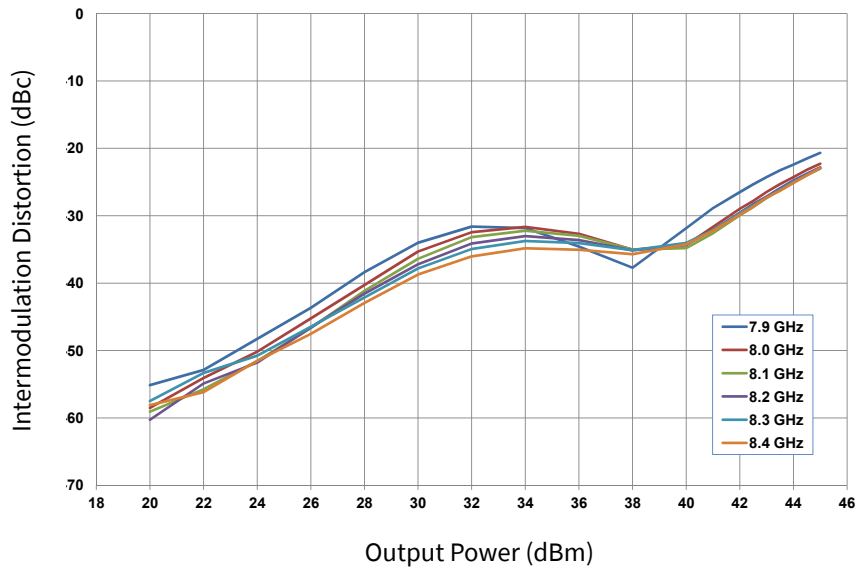

Figure 4. Two Tone IMS vs Output Power
 $V_{DD} = 40\text{ V}$, Tone Spacing = 100 kHz



CGHV96050F1 Typical Performance

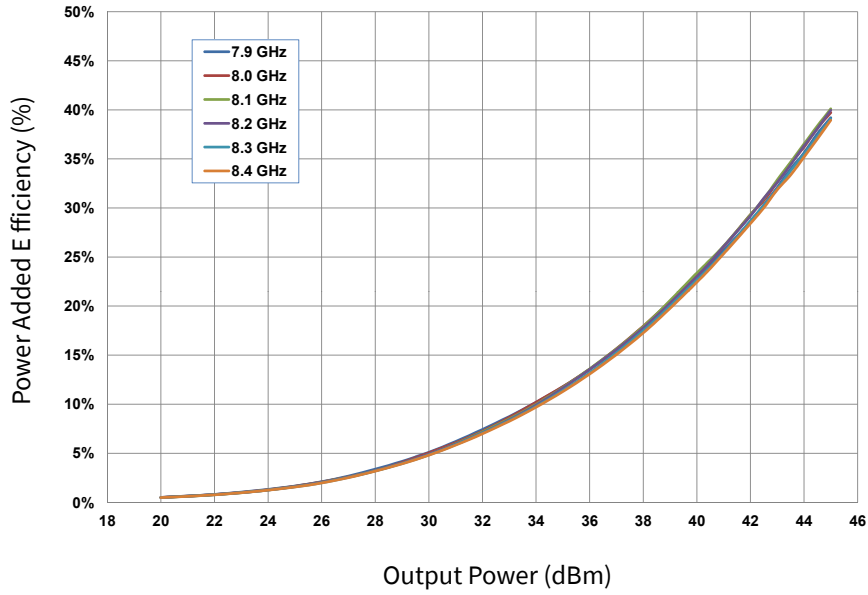

Figure 5. Two Tone Power Added Efficiency vs Output Power
 $V_{DD} = 40\text{ V}$, Tone Spacing = 100 kHz

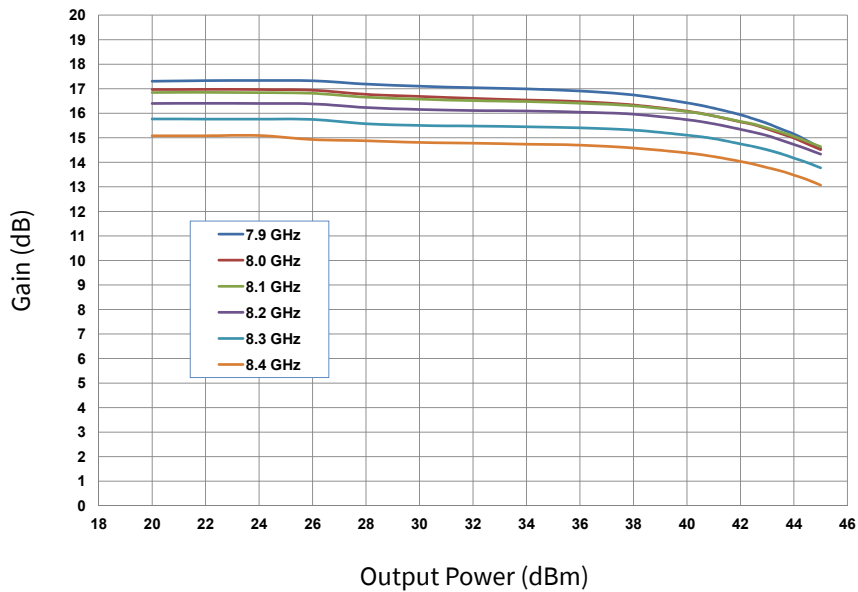

Figure 6. Two Tone Gain vs Output Power
 $V_{DD} = 40\text{ V}$, Tone Spacing = 100 kHz



CGHV96050F1 Typical Performance

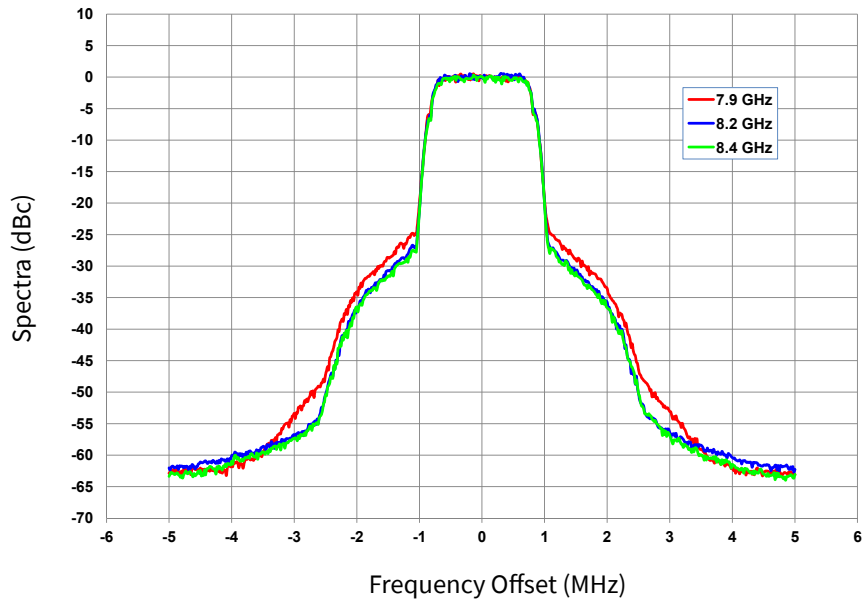

Figure 7. Spectral Mask under OQPSK Modulation, 1.6 Msps
 $V_{DD} = 40\text{ V}$, Output Power = 44 dBm / 25 W

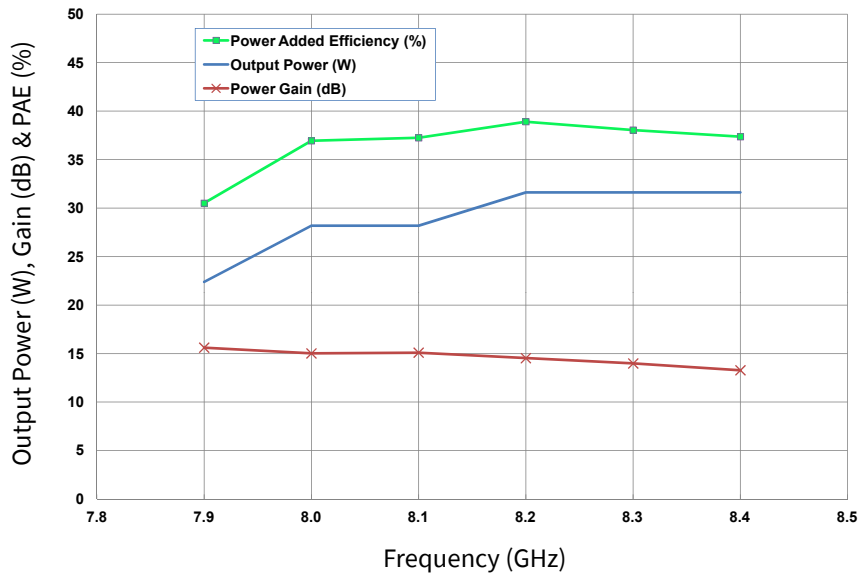

Figure 8. Linear Output Power, Gain and Power Added Efficiency vs Frequency
 $V_{DD} = 40\text{ V}$, $I_{DQ} = 500\text{ mA}$, 1.6 Msps, OQPSK Modulation at -30 dBc



CGHV96050F1 Typical Performance

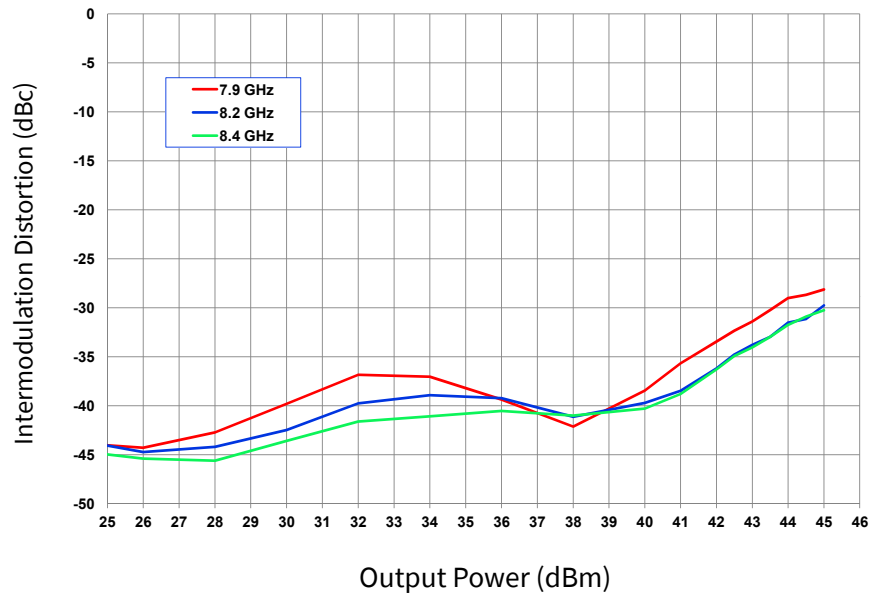

Figure 9. OQPSK Linearity vs Output Power
 $V_{DD} = 40\text{ V}$, $f = 1.6\text{ MHz}$

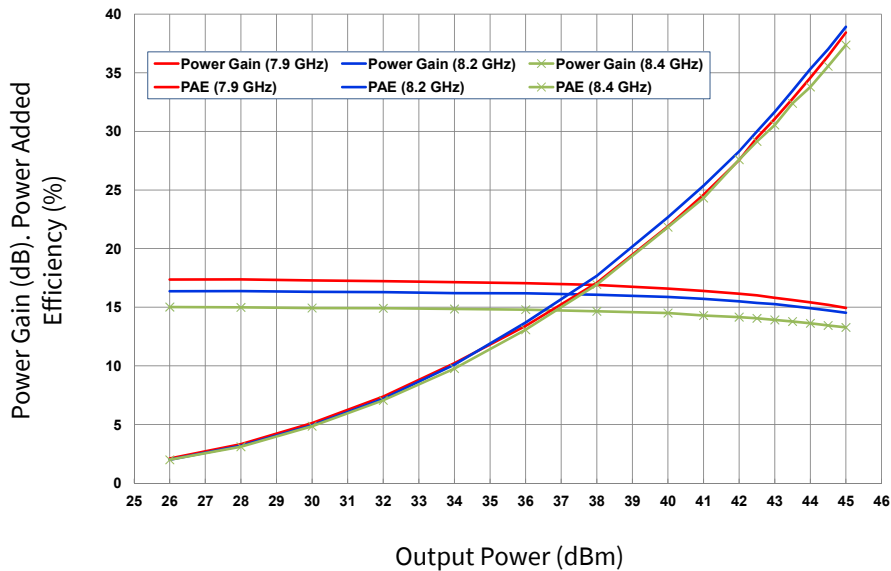

Figure 10. Power Gain and Power Added Efficiency vs Output Power
 $V_{DD} = 40\text{ V}$, $I_{DQ} = 500\text{ mA}$, 1.6 Msp s, OQPSK Modulation at -30 dBc



CGHV96050F1-AMP Demonstration Amplifier Circuit Bill of Materials

Designator	Description	Qty
R1	RES, 47 OHM, +/-1%, 1/16 W, 0603, SMD	1
R2, R3	RES, 0 OHM +/-5%, 125 mW, 1206, SMD	2
C1	CAP, 1.6pF, +/- 0.1pF, 200V, 0402, ATC 600L	1
C2	CAP, 1.0pF, +/- 0.1pF, 200V, 0402, ATC 600L	1
C3, C13	CAP, 10pF +/-5%, 0603, ATC	2
C4, C14	CAP, 470pF +/-5%, 100 V, 0603	2
C5, C15	CAP, 33000pF, 0805, 100 V, X7R	2
C11, C12	CAP, 1.8pF, +/- 0.1 pF, 200V, 0402, ATC 600L	2
C16	CAP, 1μF +/-10%, 100 V, X7P, 1210	1
C17	CAP, 33μF +/-20%, G-CASE	1
C18	CAP, 470μF, +/-20%, ELECTROLYTIC	1
J1, J2	CONNECTOR, SMA, PANEL MOUNT JACK, FLANGE, 4-HOLE, BLUNT POST, 20MIL	2
J3	CONNECTOR, HEADER, RT>PLZ .1CEN LK 9POS	1
-	PCB, TEST FIXTURE, TACONICS RF35P, 20 MIL THK, 440210 PKG	1
-	2-56 SOC HD SCREW 1/4 SS	4
-	#2 SPLIT LOCKWASHER SS	4
Q1	CGHV96050F1	1

CGHV96050F1-AMP Demonstration Amplifier Circuit

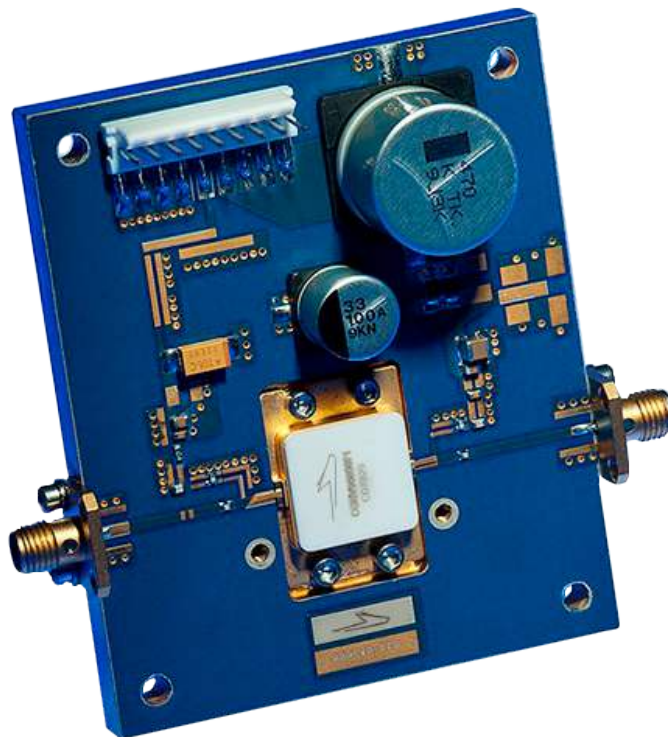



CGHV96050F1-AMP Demonstration Amplifier Circuit Schematic

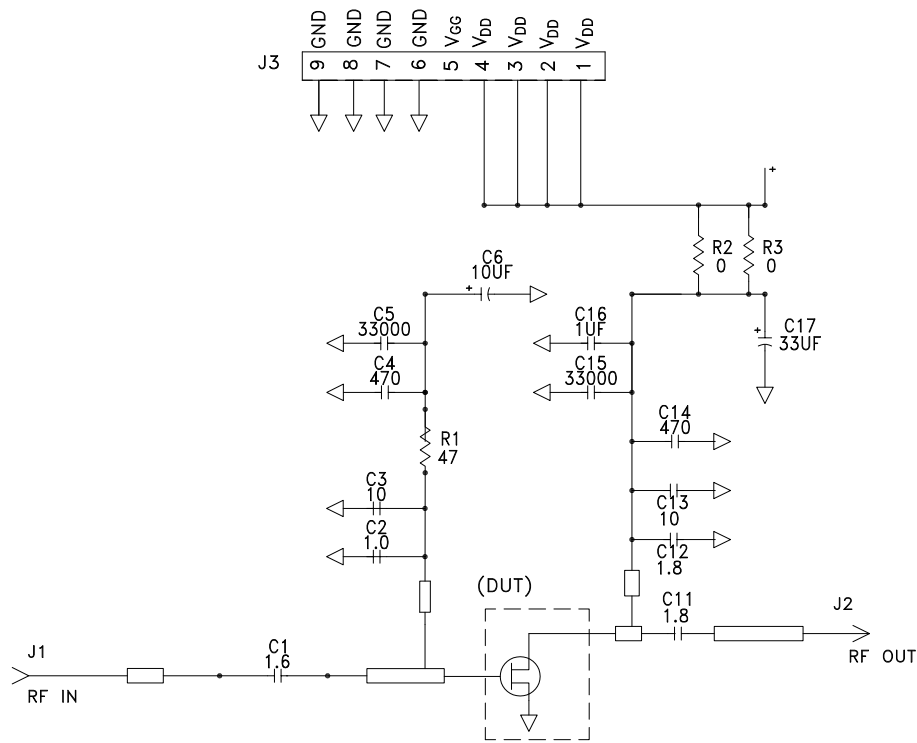

CGHV96050F1-AMP Demonstration Amplifier Circuit Outline

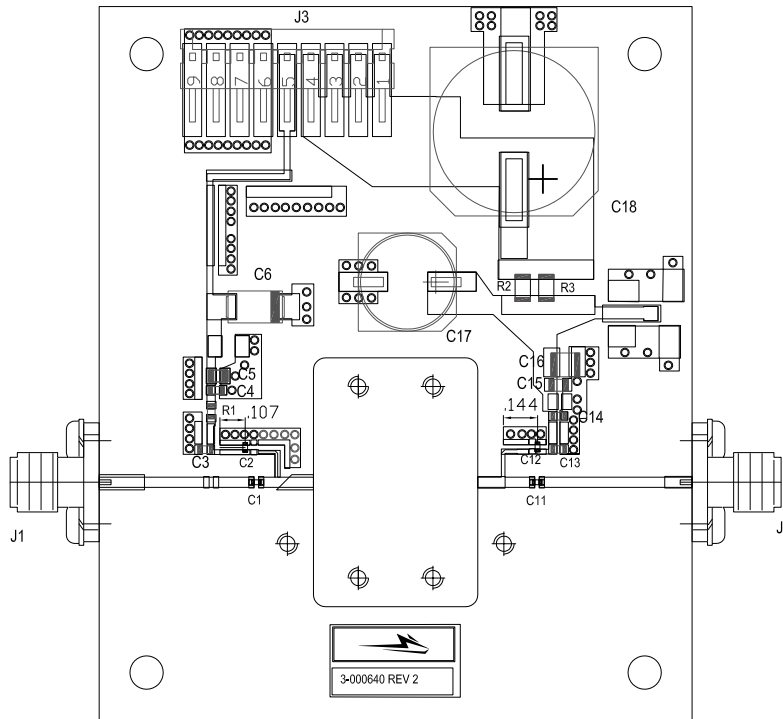



CGHV96050F1 Power Dissipation De-rating Curve

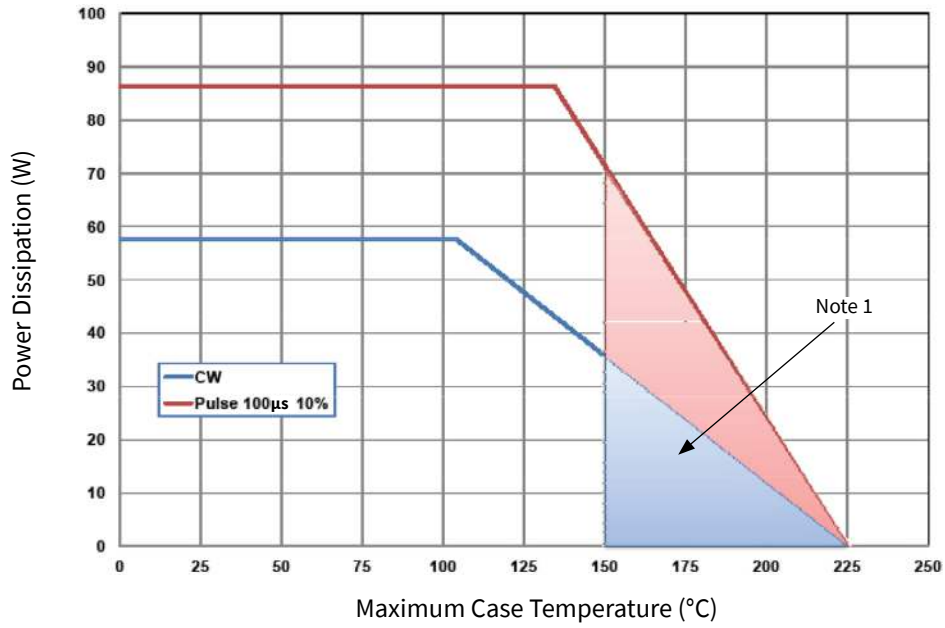

Notes:

¹ Area exceeds Maximum Case Temperature (See Page 2)

Electrostatic Discharge (ESD) Classifications

Parameter	Symbol	Class	Classification Level	Test Methodology
Human Body Model	HBM	TBD	ANSI/ESDA/JEDEC JS-001 Table 3	JEDEC JESD22 A114-D
Charge Device Model	CDM	TBD	ANSI/ESDA/JEDEC JS-002 Table 3	JEDEC JESD22 C101-C



Product Dimensions CGHV96050F1 (Package Type — 440217)

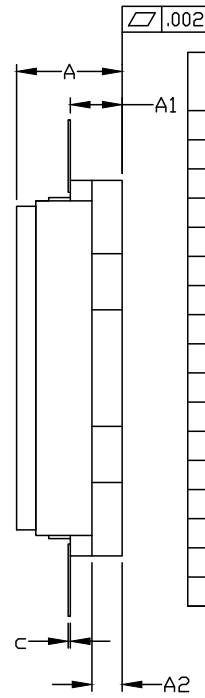
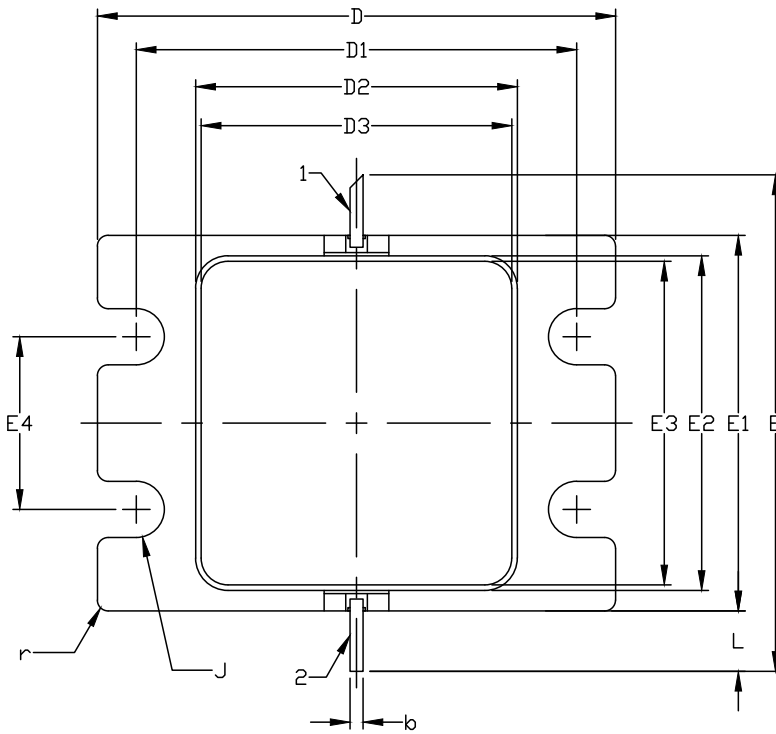

1. GATE
2. DRAIN

DIM	INCHES		MILLIMETERS		NOTES
	MIN	MAX	MIN	MAX	
A	0.185	0.201	4.70	5.11	
A1	0.088	0.100	2.24	2.54	2x
A2	0.049	0.061	1.24	1.55	
b	0.022	0.026	0.56	0.66	2x
c	0.003	0.006	0.08	0.15	
D	0.935	0.955	23.75	24.26	
D1	0.797	0.809	20.24	20.55	2x
D2	0.581	0.593	14.76	15.06	
D3	0.565	0.571	14.35	14.50	
E	0.906		23.01		REF
E1	0.679	0.691	17.25	17.55	
E2	0.604	0.616	15.34	15.65	
E3	0.588	0.594	14.93	15.09	
E4	0.309	0.321	7.85	8.15	2x
J	∅0.097	∅0.107	∅2.46	∅2.72	4x
L	0.090	0.130	2.29	3.30	2x
r	0.02 TYP		0.51 TYP		12x



Part Number System

CGHV96050F1

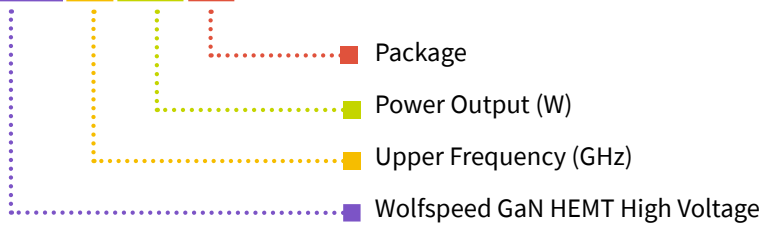

Table 1.

Parameter	Value	Units
Upper Frequency ¹	9.6	GHz
Power Output	50	W
Package	Flange	—



Note:
¹ Alpha characters used in frequency code indicate a value greater than 9.9 GHz. See Table 2 for value.

Table 2.

Character Code	Code Value
A	0
B	1
C	2
D	3
E	4
F	5
G	6
H	7
J	8
K	9
Examples:	1A = 10.0 GHz 2H = 27.0 GHz

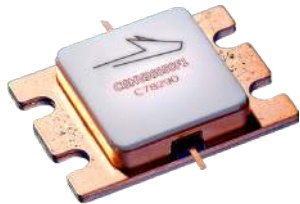

Product Ordering Information

Order Number	Description	Unit of Measure	Image
CGHV96050F1	GaN HEMT	Each	
CGHV96050F1-AMP	Test board with GaN HEMT installed	Each	

For more information, please contact:

4600 Silicon Drive
 Durham, NC 27703 USA
 Tel: +1.919.313.5300
www.wolfspeed.com/RF

Sales Contact
RFSales@wolfspeed.com

RF Product Marketing Contact
RFMarketing@wolfspeed.com

Notes & Disclaimer

Specifications are subject to change without notice. “Typical” parameters are the average values expected by Wolfspeed in large quantities and are provided for information purposes only. Wolfspeed products are not warranted or authorized for use as critical components in medical, life-saving, or life-sustaining applications, or other applications where a failure would reasonably be expected to cause severe personal injury or death. No responsibility is assumed by Wolfspeed for any infringement of patents or other rights of third parties which may result from use of the information contained herein. No license is granted by implication or otherwise under any patent or patent rights of Wolfspeed.

© 2013-2022 Wolfspeed, Inc. All rights reserved. Wolfspeed® and the Wolfstreak logo are registered trademarks and the Wolfspeed logo is a trademark of Wolfspeed, Inc.

PATENT: <https://www.wolfspeed.com/legal/patents>

The information in this document is subject to change without notice.