

3.5 GSPS Direct Digital Synthesizer with 12-Bit DAC

FEATURES

- ▶ 3.5 GSPS internal clock speed
- ▶ Integrated 12-bit DAC
- ▶ Frequency tuning resolution to 190 pHz
- ▶ 16-bit phase tuning resolution
- ▶ 12-bit amplitude scaling
- ▶ Programmable modulus
- ▶ Automatic linear and nonlinear frequency sweeping capability
- ▶ 32-bit parallel datapath interface
- ▶ 8 frequency/phase offset profiles
- ▶ Phase noise: -128 dBc/Hz (1 kHz offset at 1396 MHz)
- ▶ Wideband SFDR < -50 dBc
- ▶ Serial or parallel input/output control
- ▶ 1.8 V/3.3 V power supplies
- ▶ Software and hardware controlled power-down
- ▶ [88-lead LFCSP package](#)
- ▶ PLL REF CLK multiplier
- ▶ Phase modulation capability
- ▶ Amplitude modulation capability

APPLICATIONS

- ▶ Agile LO frequency synthesis
- ▶ Programmable clock generator
- ▶ FM chirp source for radar and scanning systems
- ▶ Test and measurement equipment
- ▶ Acousto-optic device drivers
- ▶ Polar modulator
- ▶ Fast frequency hopping

FUNCTIONAL BLOCK DIAGRAM

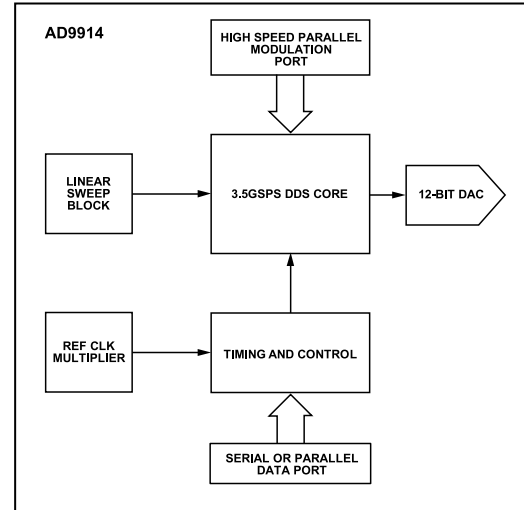

Figure 1.

TABLE OF CONTENTS

Features.....	1	12-Bit DAC Output.....	21
Applications.....	1	DAC Calibration Output.....	21
Functional Block Diagram.....	1	Reconstruction Filter.....	21
General Description.....	4	Clock Input (REF_CLK/REF_CLK).....	22
Specifications.....	5	Output Shift Keying (OSK).....	23
DC Specifications.....	5	Digital Ramp Generator (DRG).....	24
AC Specifications.....	6	Power-Down Control.....	29
Absolute Maximum Ratings.....	9	Programming and Function Pins.....	31
Thermal Performance.....	9	Serial Programming.....	34
ESD Caution.....	9	Control Interface—Serial Input/Output.....	34
Pin Configuration and Function Descriptions.....	10	General Serial Input/Output Operation.....	34
Typical Performance Characteristics.....	12	Instruction Byte.....	34
Equivalent Circuits.....	16	Serial Input/Output Port Pin Descriptions.....	34
Theory of Operation.....	17	Serial Input/Output Timing Diagrams.....	35
Single Tone Mode.....	17	MSB/LSB Transfers.....	35
Profile Modulation Mode.....	17	Parallel Programming (8-/16-Bit).....	36
Digital Ramp Modulation Mode.....	17	Register Map and Bit Descriptions.....	37
Parallel Data Port Modulation Mode.....	17	Register Bit Descriptions.....	41
Programmable Modulus Mode.....	18	Outline Dimensions.....	48
Mode Priority.....	18	Ordering Guide.....	48
Functional Block Detail.....	20	Evaluation Boards.....	48
DDS Core.....	20		

REVISION HISTORY

6/2022—Rev. F to Rev. G

Changes to Base DDS Power, PLL Disabled Parameter and Base DDS Power, PLL Enabled Parameter, Table 1.....	5
Changes to SYNC_CLK Output Driver, Duty Cycle Parameter, Data Latency (Pipeline Delay) Parameter, and SCLK Clock Rate ($1/t_{CLK}$) Parameter, Table 2.....	6
Changes to Table 5.....	10
Changes to Figure 12 Caption.....	13
Changes to Figure 14 Caption.....	13
Added Figure 22; Renumbered Sequentially.....	15
Change to Figure 23.....	15
Changes to Theory of Operation Section.....	17
Changes to Profile Modulation Mode Section.....	17
Changes to Digital Ramp Modulation Mode Section.....	17
Changes to Parallel Data Clock (SYNC_CLK) Section.....	17
Changes to Programmable Modulus Mode Section.....	18
Changes to Reconstruction Filter Section.....	21
Changes to REF_CLK/REF_CLK Overview Section and Figure 33.....	22
Changes to Direct Driven REF_CLK/REF_CLK Section.....	22
Changes to Phase-Locked Loop (PLL) Multiplier Section.....	22
Changes to PLL Lock Indication Section.....	23
Changes to DRG Overview Section and Table 9.....	24
Added Table 10; Renumbered Sequentially.....	24
Changes to DRG Slope Control Section.....	25
Changes to DRG Limit Control Section.....	26

TABLE OF CONTENTS

Changes to Figure 39.....	26
Changes to No-Dwell Ramp Generation Section and Figure 40.....	27
Changes to DROVER Pin Section.....	29
Changes to Frequency Jumping Capability in DRG Mode Section and Figure 41.....	29
Changes to Power-Down Control Section.....	29
Changes to Programming and Function Pins Section.....	31
Changes to Table 15.....	37
Changes to Table 16.....	42
Changes to Table 17.....	43
Changes to Table 18.....	44
Changes to Lower Frequency Jump Register—Address 0x09 Section and Table 25.....	45
Changes to Upper Frequency Jump Register—Address 0x0A Section and Table 26.....	46
Changes to Table 28.....	46

GENERAL DESCRIPTION

The AD9914 is a direct digital synthesizer (DDS) featuring a 12-bit DAC. The AD9914 uses advanced DDS technology, coupled with an internal high speed, high performance DAC to form a digitally programmable, complete high frequency synthesizer capable of generating a frequency-agile analog output sinusoidal waveform at up to 1.4 GHz. The AD9914 enables fast frequency hopping and fine tuning resolution (64-bit capable using programmable modulus mode). The AD9914 also offers fast phase and amplitude hopping capability. The frequency tuning and control words are loaded into the AD9914 via a serial or parallel input/output port.

The AD9914 also supports a user defined linear sweep mode of operation for generating linear swept waveforms of frequency, phase, or amplitude. A high speed, 32-bit parallel data input port is included, enabling high data rates for polar modulation schemes and fast reprogramming of the phase, frequency, and amplitude tuning words.

The AD9914 is specified to operate over the extended industrial temperature range (see the [Absolute Maximum Ratings](#) section).

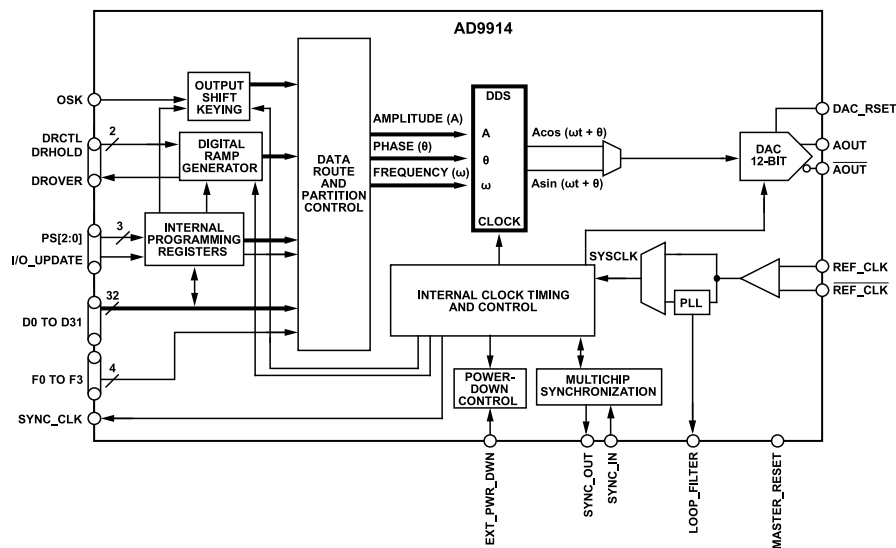

Figure 2. Detailed Block Diagram

SPECIFICATIONS

DC SPECIFICATIONS

AVDD (1.8 V) and DVDD (1.8 V) = 1.8 V ± 5%, AVDD (3.3 V) and DVDD_I/O (3.3 V) = 3.3 V ± 5%, T_A = 25°C, R_{SET} = 3.3 kΩ, I_{OUT} = 20 mA, external reference clock frequency = 3.5 GHz with reference clock (REF_CLK) multiplier bypassed, unless otherwise noted.

Table 1.

Parameter	Min	Typ	Max	Unit	Test Conditions/Comments
SUPPLY VOLTAGE					
DVDD_I/O	3.135	3.30	3.465	V	Pin 16, Pin 83
DVDD	1.71	1.80	1.89	V	Pin 6, Pin 23, Pin 73
AVDD (3.3 V)	3.135	3.30	3.465	V	Pin 34, Pin 36, Pin 39, Pin 40, Pin 43, Pin 47, Pin 50, Pin 52, Pin 53, Pin 60
AVDD (1.8 V)	1.71	1.80	1.89	V	Pin 32, Pin 56, Pin 57
SUPPLY CURRENT					
I _{DVDD_I/O}			20	mA	See also the total power dissipation specifications Pin 16, Pin 83
I _{DVDD}			433	mA	Pin 6, Pin 23, Pin 73
I _{AVDD(3.3V)}			640	mA	Pin 34, Pin 36, Pin 39, Pin 40, Pin 43, Pin 47, Pin 50, Pin 52, Pin 53, Pin 60
I _{AVDD(1.8V)}			178	mA	Pin 32, Pin 56, Pin 57
TOTAL POWER DISSIPATION					
Base DDS Power, PLL Disabled		2392	3091	mW	3.5 GHz, single-tone mode, programmable modulus disabled, linear sweep disabled, amplitude scaler disabled
Base DDS Power, PLL Enabled		2237	2627	mW	2.5 GHz, single-tone mode, programmable modulus disabled, linear sweep disabled, amplitude scaler disabled
Linear Sweep Additional Power		28		mW	
Modulus Additional Power		20		mW	
Amplitude Scaler Additional Power		138		mW	Manual or automatic
Full Power-Down Mode		400	616	mW	Using either the power-down and enable register or the EXT_PWR_DWN pin
CMOS LOGIC INPUTS					
Input High Voltage (V _{IH})	2.0		DVDD_I/O	V	
Input Low Voltage (V _{IL})			0.8	V	
Input Current (I _{INH} , I _{INL})		±60	±200	µA	At V _{IN} = 0 V and V _{IN} = DVDD_I/O
Maximum Input Capacitance (C _{IN})		3		pF	
CMOS LOGIC OUTPUTS					
Output High Voltage (V _{OH})	2.7		DVDD_I/O	V	I _{OH} = 1 mA
Output Low Voltage (V _{OL})			0.4	V	I _{OL} = 1 mA
REF CLK INPUT CHARACTERISTICS					
REF CLK inputs must always be ac-coupled (both single-ended and differential)					
REF CLK Multiplier Bypassed					
Input Capacitance		1		pF	Single-ended, each pin
Input Resistance		1.4		kΩ	Differential
Internally Generated DC Bias Voltage		2		V	
Differential Input Voltage		0.8	1.5	V p-p	
REF CLK Multiplier Enabled					
Input Capacitance		1		pF	Single-ended, each pin
Input Resistance		1.4		kΩ	Differential
Internally Generated DC Bias Voltage		2		V	
Differential Input Voltage		0.8	1.5	V p-p	

SPECIFICATIONS

AC SPECIFICATIONS

AVDD (1.8V) and DVDD (1.8V) = 1.8 V ± 5%, AVDD3 (3.3V) and DVDD_I/O (3.3V) = 3.3 V ± 5%, T_A = 25°C, R_{SET} = 3.3 kΩ, I_{OUT} = 20 mA, external reference clock frequency = 3.5 GHz with reference clock (REF CLK) multiplier bypassed, unless otherwise noted.

Table 2.

Parameter	Min	Typ	Max	Unit	Test Conditions/Comments
REF CLK INPUT					Input frequency range
REF CLK Multiplier Bypassed					
Input Frequency Range	500		3500	MHz	Maximum f _{OUT} is 0.4 × f _{SYSCLK}
Duty Cycle	45		55	%	
Minimum Differential Input Level	632			mV p-p	Equivalent to 316 mV swing on each leg
System Clock (SYSCLK) PLL Enabled					
VCO Frequency Range	2400		2500	MHz	
VCO Gain (K _V)		60		MHz/V	
Maximum PFD Rate			125	MHz	
CLOCK DRIVERS					
SYNC_CLK Output Driver					
Frequency Range			146	MHz	
Duty Cycle		33		%	See Figure 22 vs. frequency in the Typical Performance Characteristics section
Rise Time/Fall Time (20% to 80%)		650		ps	10 pF load
SYNC_OUT Output Driver					
Frequency Range			9.1	MHz	
Duty Cycle	33		66	%	CFR2 register, Bit 9 = 1
Rise Time (20% to 80%)		1350		ps	10 pF load
Fall Time (20% to 80%)		1670		ps	10 pF load
DAC OUTPUT CHARACTERISTICS					
Output Frequency Range (1 st Nyquist Zone)	0		1750	MHz	
Output Resistance		50		Ω	Single-ended (each pin internally terminated to AVDD (3.3 V))
Output Capacitance		1		pF	
Full-Scale Output Current			20.48	mA	Range depends on DAC R _{SET} resistor
Gain Error	-10		+10	% FS	
Output Offset			0.6	μA	
Voltage Compliance Range	AVDD - 0.50		AVDD + 0.50	V	
Wideband SFDR					See the Typical Performance Characteristics section
101.1 MHz Output		-66		dBc	0 MHz to 1750 MHz
427.5 MHz Output		-65		dBc	0 MHz to 1750 MHz
696.5 MHz Output		-57		dBc	0 MHz to 1750 MHz
1396.5 MHz Output		-52		dBc	0 MHz to 1750 MHz
Narrow-Band SFDR					See the Typical Performance Characteristics section
100.5 MHz Output		-95		dBc	±500 kHz
427.5 MHz Output		-95		dBc	±500 kHz
696.5 MHz Output		-95		dBc	±500 kHz
1396.5 MHz Output		-92		dBc	±500 kHz
DIGITAL TIMING SPECIFICATIONS					
Time Required to Enter Power-Down		45		ns	Power-down mode loses DAC/PLL calibration settings
Time Required to Leave Power-Down		250		ns	Must recalibrate DAC/PLL
Minimum Master Reset time	24			SYSCLK cycles	
Maximum DAC Calibration Time (t _{CAL})			135	μs	See the DAC Calibration Output section for formula

SPECIFICATIONS

Table 2.

Parameter	Min	Typ	Max	Unit	Test Conditions/Comments
Maximum PLL Calibration Time (t_{REF_CLK})			16	ms	PFD rate = 25 MHz
			8	ms	PFD rate = 50 MHz
Maximum Profile Toggle Rate			2	SYNC_CLK period	
PARALLEL PORT TIMING					
Write Timing					
Address Setup Time to \overline{WR} Active	1			ns	
Address Hold Time to Inactive			0	ns	
Data Setup Time to \overline{WR} Inactive	3.8			ns	
Data Hold Time to \overline{WR} Inactive			0	ns	
\overline{WR} Minimum Low Time			2.1	ns	
\overline{WR} Minimum High Time			3.8	ns	
Minimum \overline{WR} Time			10.5	ns	
Read Timing					
Address to Data Valid			92	ns	
Address Hold to \overline{RD} Inactive			0	ns	
\overline{RD} Active to Data Valid			69	ns	
\overline{RD} Inactive to Data Tristate			50	ns	
\overline{RD} Minimum Low Time			69	ns	
\overline{RD} Minimum High Time			50	ns	
SERIAL PORT TIMING					
SCLK Clock Rate ($1/t_{CLK}$)			80	MHz	SCLK duty cycle = 50%; maximum SCLK rate applies only to write cycles; read cycles are constrained to <3 MHz
SCLK Pulse Width High, t_{HIGH}	1.5			ns	
SCLK Pulse Width Low, t_{LOW}	5.1			ns	
SDIO to SCLK Setup Time, t_{DS}	4.9			ns	
SDIO to SCLK Hold Time, t_{DH}			0	ns	
SCLK Falling Edge to Valid Data on SDIO/ SDO, t_{DV}			78	ns	
\overline{CS} to SCLK Setup Time, t_S	4			ns	
\overline{CS} to SCLK Hold Time, t_H			0	ns	
\overline{CS} Minimum Pulse Width High, t_{PWH}	4			ns	
DATA PORT TIMING					
D[31:0] Setup Time to SYNC_CLK	2			ns	
D[31:0] Hold Time to SYNC_CLK			0	ns	
F[3:0] Setup Time to SYNC_CLK	2			ns	
F[3:0] Hold Time to SYNC_CLK			0	ns	
IO_UPDATE Pin Setup Time to SYNC_CLK	2			ns	
IO_UPDATE Pin Hold Time to SYNC_CLK			0	ns	
Profile Pin Setup Time to SYNC_CLK	2			ns	
Profile Pin Hold Time to SYNC_CLK			0	ns	
DR_CTL/DR_HOLD Setup Time to SYNC_CLK	2			ns	
DR_CTL/DR_HOLD Hold Time to SYNC_CLK			0	ns	
DATA LATENCY (PIPELINE DELAY)					
Single Tone Mode or Profile Mode (Matched Latency Disabled)					1 SYSCLK cycle = 1 period of the system clock ($1/f_S$)
Frequency		318		SYSCLK cycles	OSK disabled
		342		SYSCLK cycles	OSK enabled
Phase		294		SYSCLK cycles	OSK disabled
		318		SYSCLK cycles	OSK enabled

SPECIFICATIONS

Table 2.

Parameter	Min	Typ	Max	Unit	Test Conditions/Comments
Amplitude Single Tone Mode or Profile Mode (Matched Latency Enabled)		102		SYSClk cycles	OSK enabled
Frequency		318		SYSClk cycles	OSK disabled
Phase		342		SYSClk cycles	OSK enabled
Amplitude		318		SYSClk cycles	OSK disabled
Frequency		342		SYSClk cycles	OSK enabled
Phase		294		SYSClk cycles	OSK disabled
Amplitude		318		SYSClk cycles	OSK enabled
Modulation Mode with 32-Bit Parallel Port (Matched Latency Disabled)		102		SYSClk cycles	OSK enabled
Frequency		318		SYSClk cycles	OSK disabled
Phase		342		SYSClk cycles	OSK enabled
Amplitude		318		SYSClk cycles	OSK disabled
Frequency		342		SYSClk cycles	OSK enabled
Phase		318		SYSClk cycles	OSK disabled
Amplitude		342		SYSClk cycles	OSK enabled
Modulation Mode with 32-Bit Parallel Port (Matched Latency Enabled)		318		SYSClk cycles	OSK disabled
Frequency		342		SYSClk cycles	OSK enabled
Phase		318		SYSClk cycles	OSK disabled
Amplitude		342		SYSClk cycles	OSK enabled
Sweep Mode (Match Latency Disabled)		342		SYSClk cycles	OSK disabled
Frequency		366		SYSClk cycles	OSK enabled
Phase		318		SYSClk cycles	OSK disabled
Amplitude		342		SYSClk cycles	OSK enabled
Sweep Mode (Match Latency Enabled)		126		SYSClk cycles	OSK enabled
Frequency		342		SYSClk cycles	OSK disabled
Phase		366		SYSClk cycles	OSK enabled
Amplitude		342		SYSClk cycles	OSK disabled
Frequency		366		SYSClk cycles	OSK enabled
Phase		342		SYSClk cycles	OSK disabled
Amplitude		366		SYSClk cycles	OSK enabled
Frequency		366		SYSClk cycles	OSK enabled

ABSOLUTE MAXIMUM RATINGS

Table 3.

Parameter	Rating
AVDD (1.8 V), DVDD (1.8 V) Supplies	2 V
AVDD (3.3 V), DVDD_I/O (3.3 V) Supplies	4 V
Digital Input Voltage	-0.7 V to +4 V
Digital Output Current	5 mA
Storage Temperature Range	-65°C to +150°C
Operating Temperature Range	-40°C to +85°C
Maximum Junction Temperature	150°C
Lead Temperature (10 sec Soldering)	300°C

Stresses at or above those listed under Absolute Maximum Ratings may cause permanent damage to the product. This is a stress rating only; functional operation of the product at these or any other conditions above those indicated in the operational section of this specification is not implied. Operation beyond the maximum operating conditions for extended periods may affect product reliability.

THERMAL PERFORMANCE

Table 4.

Symbol	Description	Value ¹	Unit
θ_{JA}	Junction-to-ambient thermal resistance (still air) per JEDEC JESD51-2	24.1	°C/W
θ_{JMA}	Junction-to-ambient thermal resistance (1.0 m/sec airflow) per JEDEC JESD51-6	21.3	°C/W
θ_{JMA}	Junction-to-ambient thermal resistance (2.0 m/sec air flow) per JEDEC JESD51-6	20.0	°C/W
θ_{JB}	Junction-to-board thermal resistance (still air) per JEDEC JESD51-8	13.3	°C/W
Ψ_{JB}	Junction-to-board characterization parameter (still air) per JEDEC JESD51-6	12.8	°C/W
θ_{JC}	Junction-to-case thermal resistance	2.21	°C/W
Ψ_{JT}	Junction-to-top-of-package characterization parameter (still air) per JEDEC JESD51-2	0.23	°C/W

¹ Results are from simulations. Printed circuit board (PCB) is JEDEC multilayer. Thermal performance for actual applications requires careful inspection of the conditions in the application to determine if they are similar to those assumed in these calculations.

ESD CAUTION



ESD (electrostatic discharge) sensitive device. Charged devices and circuit boards can discharge without detection. Although this product features patented or proprietary protection circuitry, damage may occur on devices subjected to high energy ESD. Therefore, proper ESD precautions should be taken to avoid performance degradation or loss of functionality.

PIN CONFIGURATION AND FUNCTION DESCRIPTIONS

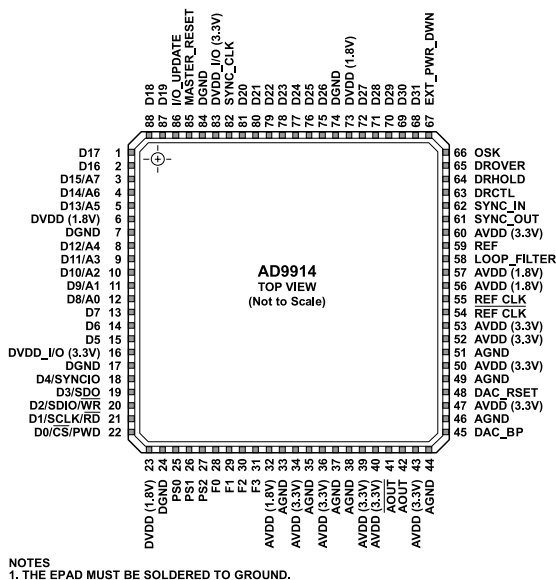

Figure 3. Pin Configuration

Table 5. Pin Function Descriptions

Pin No.	Mnemonic	I/O ¹	Description
1, 2, 13 to 15, 68 to 72, 75 to 81, 87, 88	D5 to D7, D16 to D31, D27 to D31	I/O	Parallel Port Pins. The 32-bit parallel port offers the option for serial or parallel programming of the internal registers. In addition, the parallel port can be configured to provide direct FSK, PSK, or ASK (or combinations thereof) modulation data. The 32-bit parallel port configuration is set by the state of the four function pins (F0 to F3).
3	D15/A7	I/O	Parallel Port Pin/Address Line. The state of the F0 to F3 function pins determines if this pin acts as a line for direct FSK, PSK, or ASK data or as an address line for programming the internal registers.
4	D14/A6	I/O	Parallel Port Pin/Address Line. The state of the F0 to F3 function pins determines if this pin acts as a line for direct FSK, PSK, or ASK data or as an address line for programming the internal registers.
5	D13/A5	I/O	Parallel Port Pin/Address Line. The state of the F0 to F3 function pins determines if this pin acts as a line for direct FSK, PSK, or ASK data or as an address line for programming the internal registers.
8	D12/A4	I/O	Parallel Port Pin/Address Line. The state of the F0 to F3 function pins determines if this pin acts as a line for direct FSK, PSK, or ASK data or as an address line for programming the internal registers.
9	D11/A3	I/O	Parallel Port Pin/Address Line. The state of the F0 to F3 function pins determines if this pin acts as a line for direct FSK, PSK, or ASK data or as an address line for programming the internal registers.
10	D10/A2	I/O	Parallel Port Pin/Address Line. Multipurpose pin depending on the state of the function pins (F0 to F3). The state of the F0 to F3 function pins determines if this pin acts as a line for direct FSK, PSK, or ASK data or as an address line for programming the internal registers.
11	D9/A1	I/O	Parallel Port Pin/Address Line. Multipurpose pin depending on the state of the function pins (F0 to F3). The state of the F0 to F3 function pins determines if this pin acts as a line for direct FSK, PSK, or ASK data or as an address line for programming the internal registers.
12	D8/A0	I/O	Parallel Port Pin/Address Line. The state of the F0 to F3 function pins determines if this pin acts as a line for direct FSK, PSK, or ASK data or as an address line for programming the internal registers.
18	D4/SYNCIO	I	Parallel Port Pin/Serial Port Synchronization Pin. This pin is D4 for direct FSK, PSK, or ASK data. If serial mode is invoked via F0 to F3, this pin resets the serial port.
19	D3/SDO	I/O	Parallel Port Pin/Serial Data Output. This pin is D3 for direct FSK, PSK, or ASK data. If serial mode is invoked via F0 to F3, this pin is used for readback mode for serial operation.
20	D2/SDIO/WR	I/O	Parallel Port Pin/Serial Data Input and Output/Write Input. This pin is D2 for direct FSK, PSK, or ASK data. If serial mode is invoked via F0 to F3, this pin is used for the SDIO for serial operation. If parallel mode is enabled, this pin invokes a write operation for updating the values of the internal registers.
21	D1/SCLK/RD	I	Parallel Port Pin/Serial Clock/Read Input. This pin is D1 for direct FSK, PSK, or ASK data. If serial mode is invoked via F0 to F3, this pin is used for SCLK for serial operation. If parallel mode is enabled, this pin invokes a read operation for reading back the value of the internal registers.

PIN CONFIGURATION AND FUNCTION DESCRIPTIONS

Table 5. Pin Function Descriptions

Pin No.	Mnemonic	I/O ¹	Description
22	D0/CS/PWD	I	Parallel Port Pin/Chip Select/Parallel Width. This pin is D0 for direct FSK, PSK, or ASK data. If serial mode is invoked via F0 to F3, this pin is used for the chip select for serial operation. If parallel mode is enabled, this pin sets either 8-bit data or 16-bit data.
6, 23, 73	DVDD (1.8V)	I	Digital Core Supplies (1.8 V).
7, 17, 24, 74, 84	DGND	I	Digital Ground.
16, 83	DVDD_I/O (3.3V)	I	Digital Input/Output Supplies (3.3 V).
32, 56, 57	AVDD (1.8V)	I	Analog Core Supplies (1.8 V).
33, 35, 37, 38, 44, 46, 49, 51	AGND	I	Analog Ground.
34, 36, 39, 40, 43, 47, 50, 52, 53, 60	AVDD (3.3V)	I	Analog DAC Supplies (3.3 V).
25, 26, 27	PS0 to PS2	I	Profile Select Pins. Digital inputs (active high). Use these pins to select one of eight phase/frequency profiles for the DDS. Changing the state of one of these pins transfers the current contents of all input/output buffers to the corresponding registers. State changes must be set up on the SYNC_CLK pin (Pin 82).
28, 29, 30, 31	F0 to F3	I	Function Pins. Digital inputs. The state of these pins determines if a serial or parallel interface is used. In addition, the function pins determine how the 32-bit parallel data-word is partitioned for FSK, PSK, or ASK modulation mode.
41	$\overline{\text{AOUT}}$	O	DAC Complementary Output Source. Analog output (voltage mode). Internally connected through a 50 Ω resistor to AVDD (3.3 V).
42	AOUT	O	DAC Output Source. Analog output (voltage mode). Internally connected through a 50 Ω resistor to AVDD (3.3 V).
45	DAC_BP	I	DAC Bypass Pin. Provides access to the common control node of the DAC current sources. Connecting a capacitor between this pin and ground can improve noise performance at the DAC output.
48	DAC_RSET	O	Analog Reference. This pin programs the DAC output full-scale reference current. Connect a 3.3 k Ω resistor to AGND.
54	$\overline{\text{REF_CLK}}$	I	Complementary Reference Clock Input. Analog input.
55	REF_CLK	I	Reference Clock Input. Analog input.
58	LOOP_FILTER	O	External PLL Loop Filter Node.
59	REF	O	Local PLL Reference Supply. Typically at 2.05 V.
61	SYNC_OUT	O	Digital Synchronization Output. Clock source (output) for synchronizing multiple chips.
62	SYNC_IN	I	Digital Synchronization Input. Clock receiver (input) for synchronizing multiple chips.
63	DRCTL	I	Ramp Control. Digital input (active high). This pin controls the sweep direction (up/down).
64	DRHOLD	I	Ramp Hold. Digital input (active high). Pauses the sweep when active.
65	DROVER	O	Ramp Over. Digital output (active high). This pin switches to Logic 1 when the digital ramp generator reaches the programmed upper or lower limit.
66	OSK	I	Output Shift Keying. Digital input (active high). When the OSK features are placed in either manual or automatic mode, this pin controls the OSK function. In manual mode, it toggles the multiplier between 0 (low) and the programmed amplitude scale factor (high). In automatic mode, a low sweeps the amplitude down to zero and a high sweeps the amplitude up to the amplitude scale factor. This pin is only functional when enabled via a register bit.
67	EXT_PWR_DWN	I	External Power-Down. Digital input (active high). A high level on this pin initiates the currently programmed power-down mode.
82	SYNC_CLK	O	Clock Output. Digital output. Many of the digital inputs on the chip, such as I/O_UPDATE, PS[2:0], and the parallel data port (D0 to D31), must be set up on the rising edge of this signal.
85	MASTER_RESET	I	Master Reset. Digital input (active high). Clears all memory elements and sets registers to default values.
86	I/O_UPDATE	I	Input/Output Update. Digital input (active high). A high on this pin transfers the contents of the input/output buffers to the corresponding internal registers.
	EPAD		Exposed Pad. The EPAD must be soldered to ground.

¹ I = input, O = output.

TYPICAL PERFORMANCE CHARACTERISTICS

Nominal supply voltage; DAC $R_{SET} = 3.3\text{ k}\Omega$, $T_A = 25^\circ\text{C}$, unless otherwise noted.

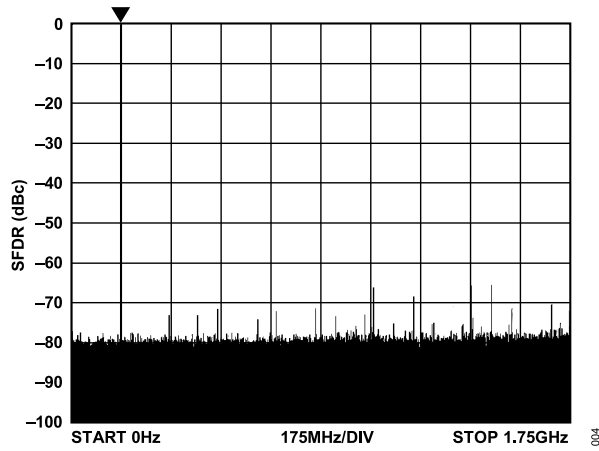

Figure 4. Wideband SFDR at 171.5 MHz, SYSCLK = 3.5 GHz (SYSCLK PLL Bypassed)

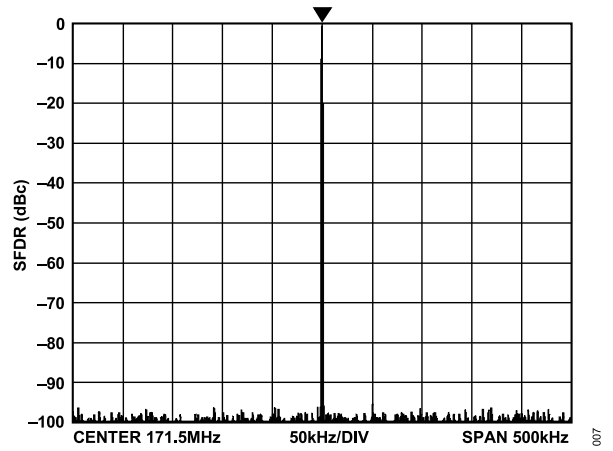

Figure 7. Narrow-Band SFDR at 171.5 MHz, SYSCLK = 3.5 GHz (SYSCLK PLL Bypassed)

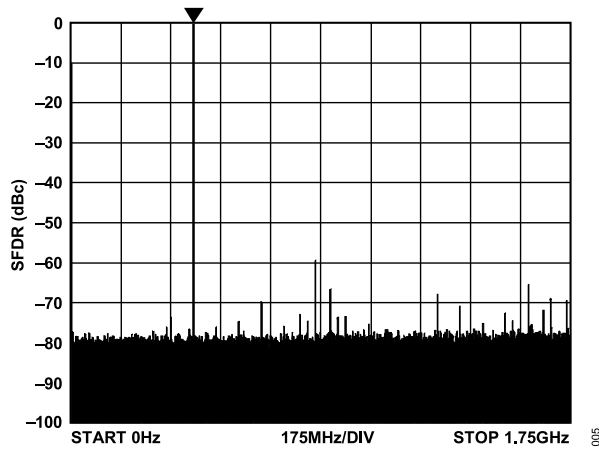

Figure 5. Wideband SFDR at 427.5 MHz, SYSCLK = 3.5 GHz (SYSCLK PLL Bypassed)

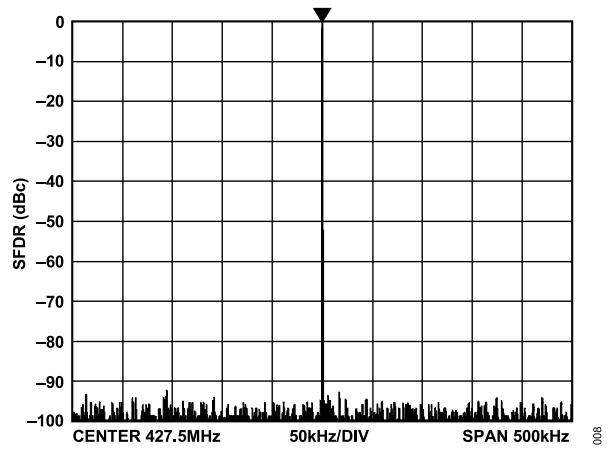

Figure 8. Narrow-Band SFDR at 427.5 MHz, SYSCLK = 3.5 GHz (SYSCLK PLL Bypassed)

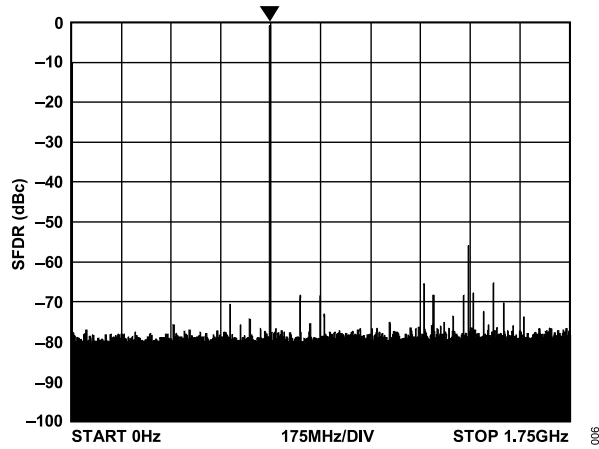

Figure 6. Wideband SFDR at 696.5 MHz, SYSCLK = 3.5 GHz (SYSCLK PLL Bypassed)

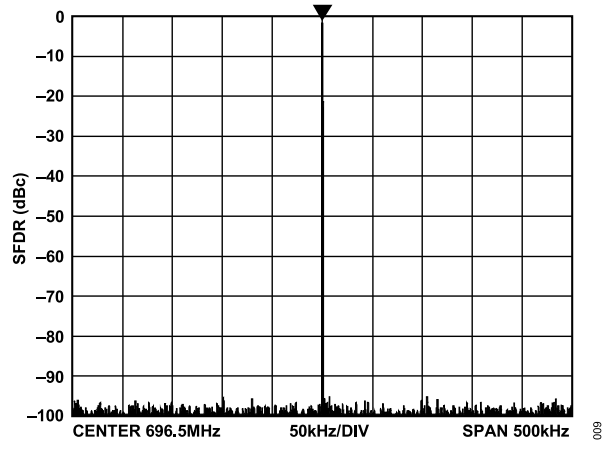

Figure 9. Narrow-Band SFDR at 696.5 MHz, SYSCLK = 3.5 GHz (SYSCLK PLL Bypassed)

TYPICAL PERFORMANCE CHARACTERISTICS

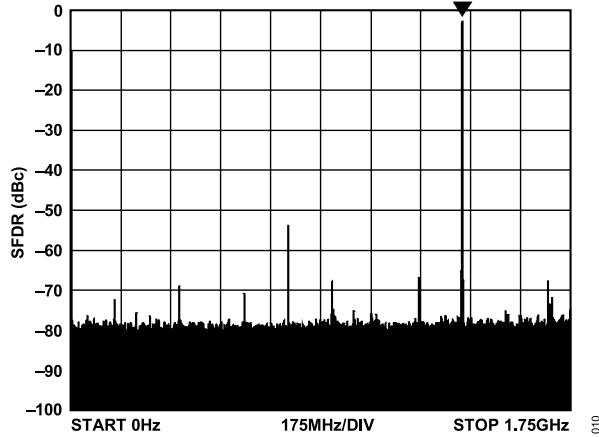

Figure 10. Wideband SFDR at 1396.5 MHz, SYSCLK = 3.5 GHz (SYSCLK PLL Bypassed)

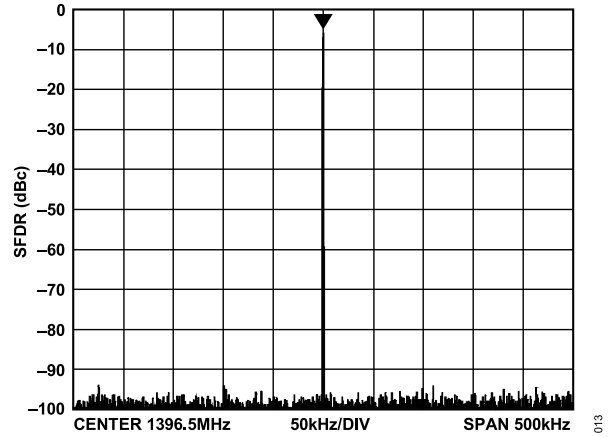

Figure 13. Narrow-Band SFDR at 1396.5 MHz, SYSCLK = 3.5 GHz (SYSCLK PLL Bypassed)

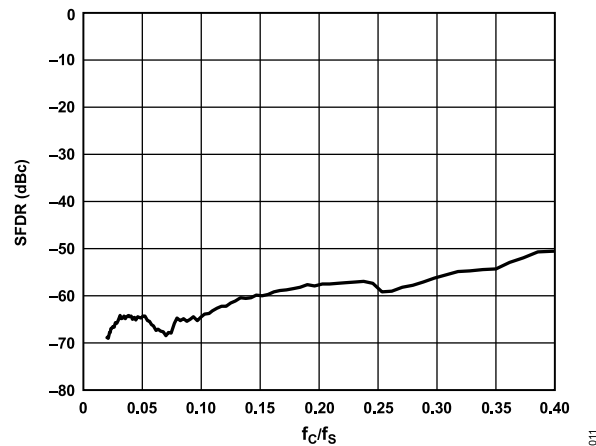

Figure 11. Wideband SFDR vs. Normalized f_{OUT} , SYSCLK = 3.5 GHz

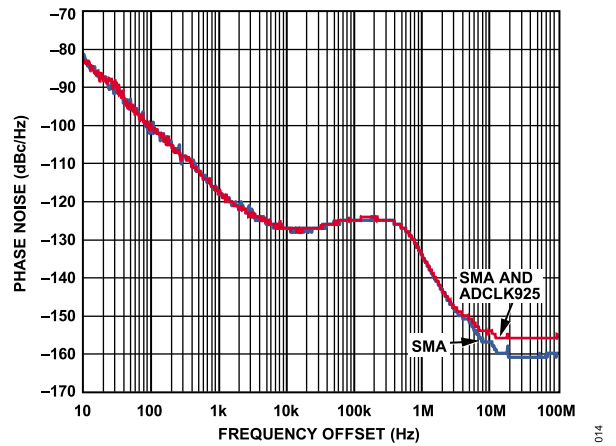

Figure 14. Absolute Phase Noise of REF CLK Source (Rohde & Schwarz SMA100 Signal Generator at 3.5 GHz Buffered by Series ADCLK925) Driving AD9914

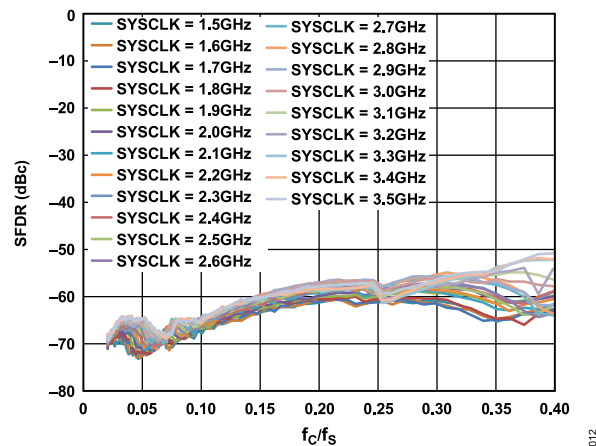

Figure 12. Wideband SFDR vs. Normalized f_{OUT} , SYSCLK = 1.5 GHz to 3.5 GHz

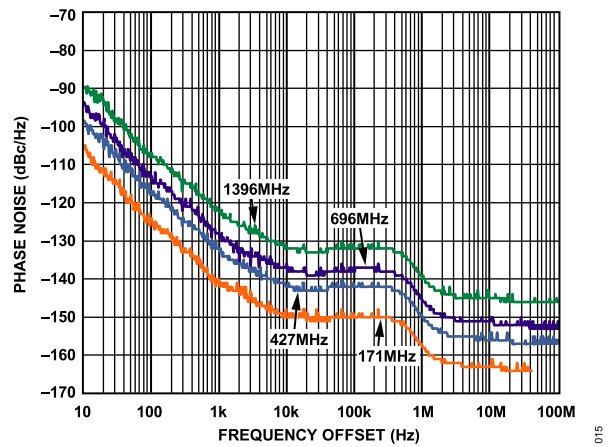

Figure 15. Absolute Phase Noise Curves of DDS Output at 3.5 GHz Operation

TYPICAL PERFORMANCE CHARACTERISTICS

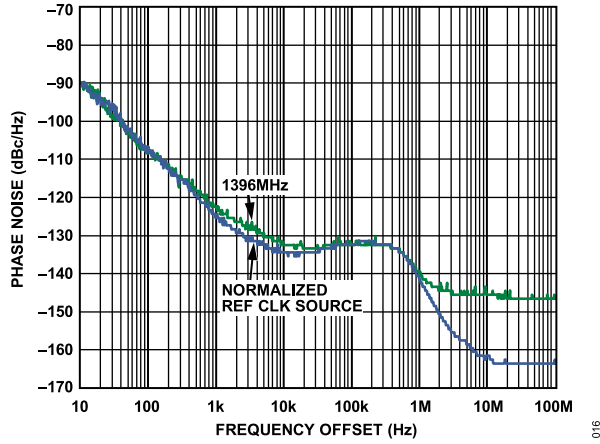

Figure 16. Absolute Phase Noise Curves of Normalized REF CLK Source to DDS Output at 1396 MHz (SYSCLK = 3.5 GHz)

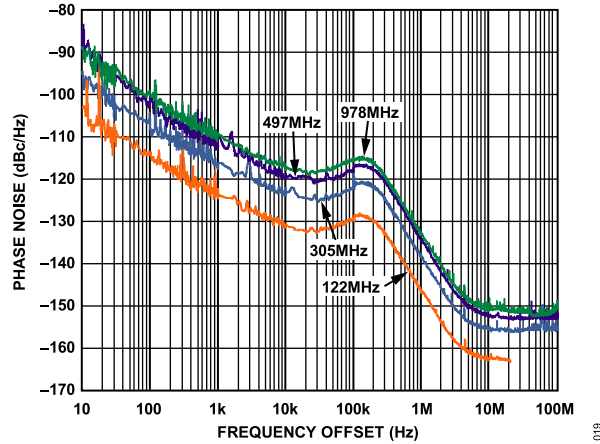

Figure 19. Absolute Phase Noise Curves of DDS Output Using Internal PLL at 2.5 GHz Operation

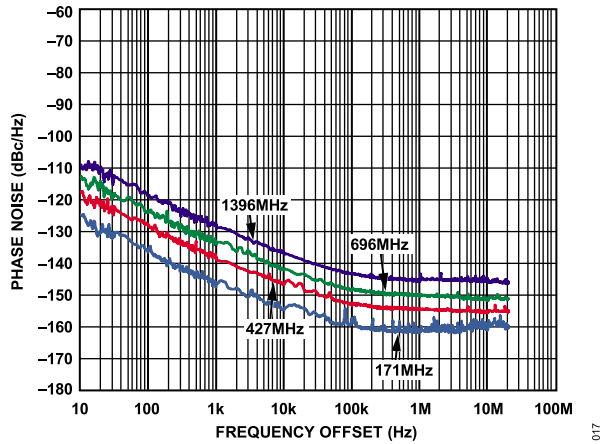

Figure 17. Residual Phase Noise Curves

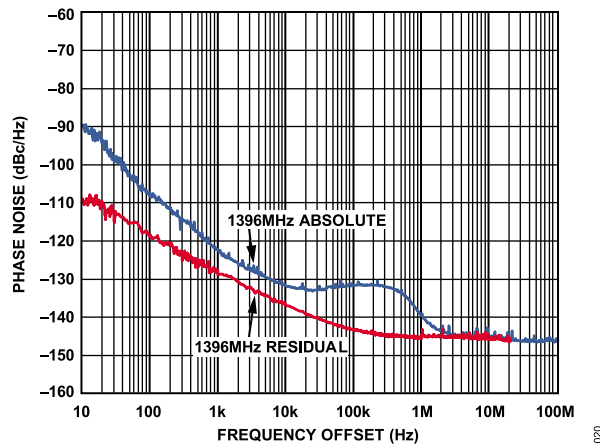

Figure 20. Residual PN vs. Absolute PN Measurement Curves at 1396 MHz

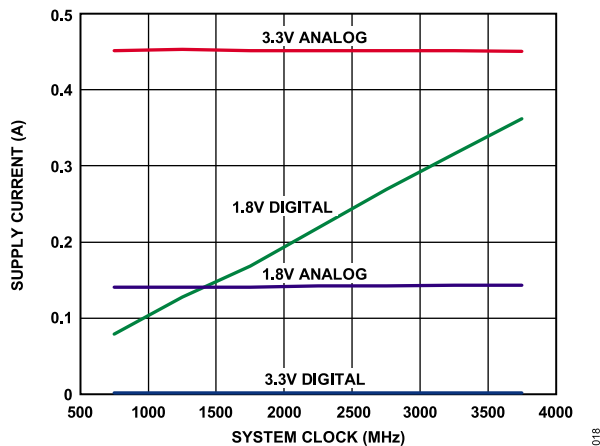

Figure 18. Power Supply Current vs. SYSCLK

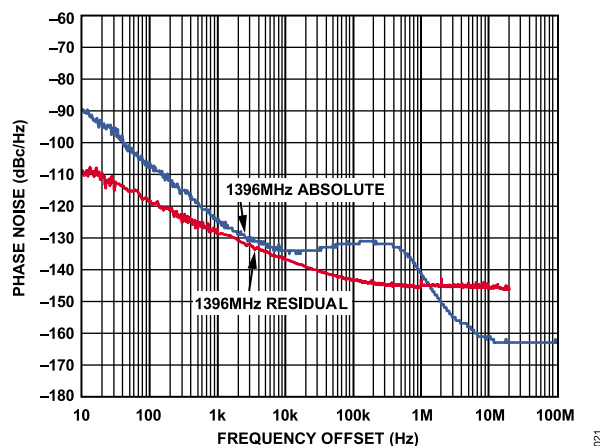

Figure 21. Residual Phase Noise vs. Normalized Absolute REF CLK Source Phase Noise at 1396 MHz

TYPICAL PERFORMANCE CHARACTERISTICS

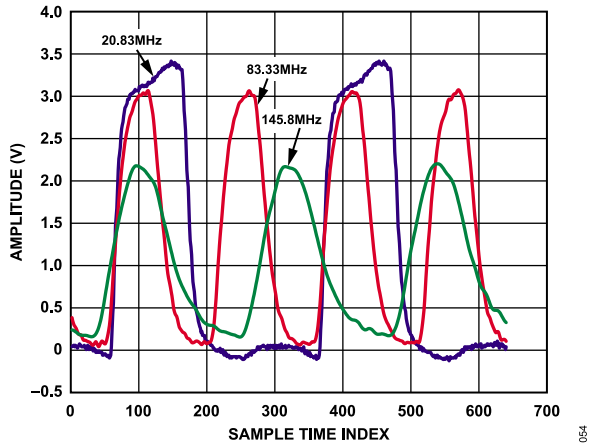

Figure 22. SYNC_CLK Amplitude at Various Frequencies ($f_{\text{SYSCLK}}/24$), Measured at the SYNC_CLK Pin Using an Active Probe (1 GHz Bandwidth, 1 Ω , 1 pF) with the SYNC_CLK Pin Loaded by a 1-inch PCB Trace Connected to an Open SMA Connector

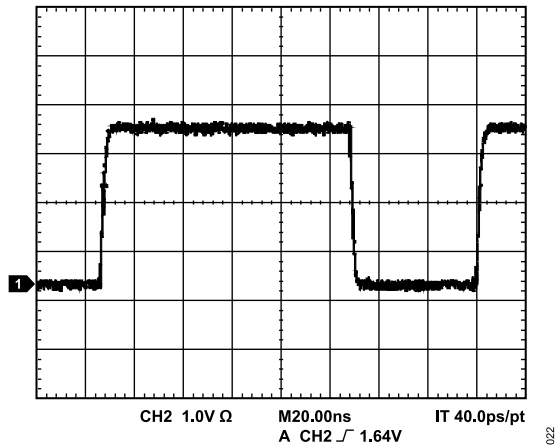

Figure 23. SYNC_OUT ($f_{\text{SYSCLK}}/384$)

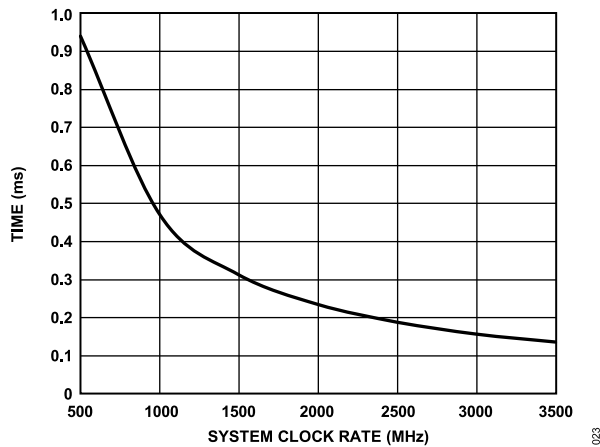

Figure 24. DAC Calibration Time vs. SYSCLK Rate. See the [DAC Calibration Output Section](#) for Formula.

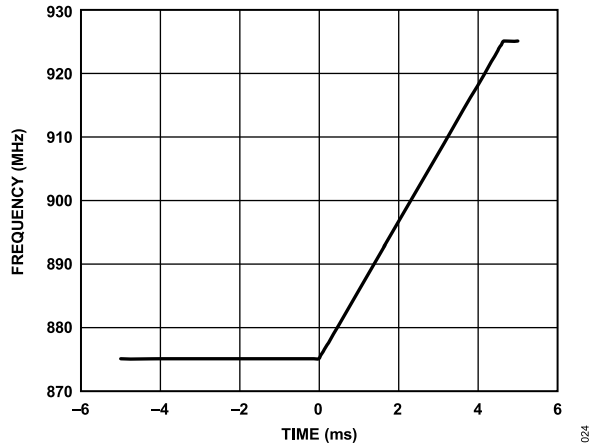

Figure 25. Measured Rising Linear Frequency Sweep

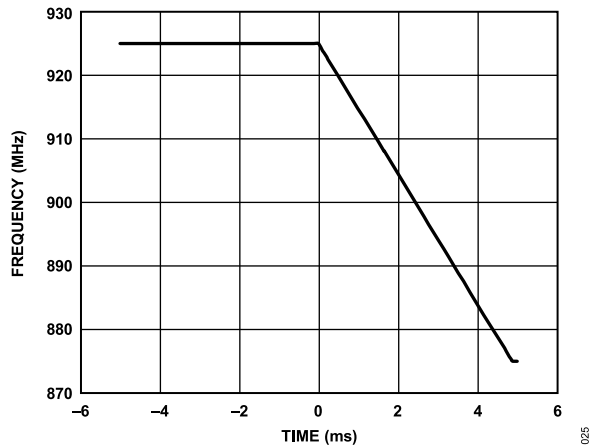

Figure 26. Measured Falling Linear Frequency Sweep

EQUIVALENT CIRCUITS

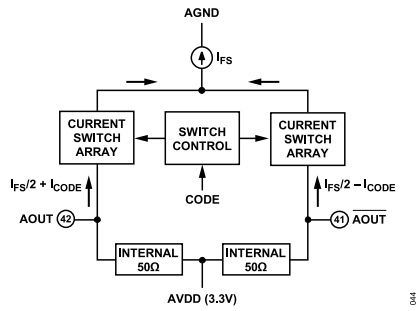

Figure 27. DAC Output

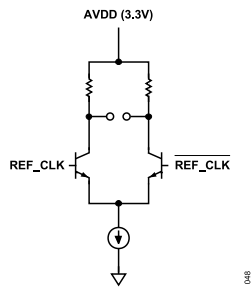

Figure 28. REF CLK input

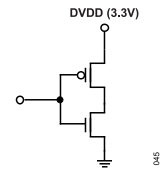

Figure 29. CMOS Input

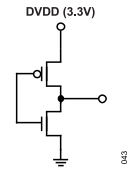

Figure 30. CMOS Output

THEORY OF OPERATION

The AD9914 has five modes of operation.

- ▶ Single tone
- ▶ Profile modulation
- ▶ Digital ramp modulation (linear sweep)
- ▶ Parallel data port modulation
- ▶ Programmable modulus mode

The modes define the data source that supplies the DDS with the signal control parameters: frequency, phase, or amplitude. The partitioning of the data into different combinations of frequency, phase, and amplitude is established based on the mode and/or specific control bits and function pins.

Although the various modes are described independently, they can be enabled simultaneously. This provides an unprecedented level of flexibility for generating complex modulation schemes. However, to avoid multiple data sources from driving the same DDS signal control parameter, the device has a built-in priority protocol.

In single tone mode, the DDS signal control parameters come directly from the profile programming registers. In digital ramp modulation mode, the DDS signal control parameters are delivered by a digital ramp generator. In parallel data port modulation mode, the DDS signal control parameters are driven directly into the parallel port.

The various modulation modes generally operate on only one of the DDS signal control parameters (two in the case of the polar modulation format via the parallel data port). The unmodulated DDS signal control parameters are stored in programming registers and automatically routed to the DDS based on the selected mode.

A separate output shift keying (OSK) function is also available. This function affects only the amplitude parameter of the DDS. The OSK function has priority over the other data sources that can drive the DDS amplitude parameter. As such, no other data source can drive the DDS amplitude when the OSK function is enabled.

SINGLE TONE MODE

In single tone mode, the DDS signal control parameters are supplied directly from the profile programming registers. A profile is an independent register that contains the DDS signal control parameters. Eight profile registers are available. Note that the profile pins must select the desired register.

PROFILE MODULATION MODE

Each profile is independently accessible. For FSK, PSK, or ASK modulation, use the three external profile pins (PS[2:0]) to select the desired profile. A change in the state of the profile pins with the next rising edge on SYNC_CLK updates the DDS with the parameters specified by the selected profile. Therefore, the profile change must meet the setup and hold times to the SYNC_CLK rising edge. Note that amplitude control must also be enabled via the OSK enable bit in the CFR1 register (0x00[8]).

DIGITAL RAMP MODULATION MODE

In digital ramp modulation mode, the DRG directly modulates one of the DDS signal control parameters (frequency, phase, or amplitude) via a dedicated 32-bit sweep accumulator (the sweep accumulator is completely independent of the 32-bit phase accumulator in the DDS core). The user controls the characteristics of a ramp (for example, sweep range, step size, and step rate) by programming the appropriate registers via the serial or parallel input/output port. The registers provide the user with the ability to control the rising and falling characteristics of a ramp independently.

The ramp is digitally generated via the 32-bit sweep accumulator within the DRG. The user can program the digital ramp generator (DRG) to direct the 32-bit output of the sweep accumulator to affect the frequency, phase, or amplitude parameter of the DDS. When programmed for a frequency sweep, all 32 bits of the sweep accumulator are delivered to the DDS for frequency control. When programmed for a phase sweep, the 16 LSBs of the sweep accumulator are delivered to the DDS for phase control. Therefore, for a phase sweep, the 16 MSBs of the 32-bit registers normally used for frequency sweeping must be programmed with zeros. When programmed for an amplitude sweep, the 12 LSBs of the sweep accumulator are delivered to the DDS for amplitude control. Therefore, for an amplitude sweep, the 20 MSBs of the 32-bit registers normally used for frequency sweeping must be programmed with zeros.

The ramp direction (rising or falling) is externally controlled by the DRCTL pin. The user can also suspend the operation of the ramp generator by asserting the DRHOLD pin. Note that the DRG requires the amplitude control of the DDS to be enabled via the OSK enable bit in Register CFR1.

PARALLEL DATA PORT MODULATION MODE

In parallel data port modulation mode, the modulated DDS signal control parameter(s) are supplied directly from the 32-bit parallel data port. The function pins define how the 32-bit data-word is applied to the DDS signal control parameters. Formatting of the 32-bit data-word is unsigned binary, regardless of the destination.

Parallel Data Clock (SYNC_CLK)

The AD9914 has an internal clock signal (SYNC_CLK) that runs at 1/24 of the DAC sample rate. SYNC_CLK is the primary internal timing signal of the AD9914. For example, the PS[2:0] pins, DRCTL pin, and DRHOLD pin are all gated internally by SYNC_CLK.

In parallel data port modulation mode (CFR2[22] = 1), the AD9914 uses the rising edge of SYNC_CLK to capture the logic level applied to the D[31:0] pins and the F[3:0] pins. Thus, the parallel data port essentially operates at the SYNC_CLK rate in parallel data port modulation mode.

Because the AD9914 uses the internal SYNC_CLK signal to capture the state of the D[31:0] and F[3:0] pins in parallel data port

THEORY OF OPERATION

modulation mode, an external replica of the SYNC_CLK signal is useful for controlling external circuitry used to drive the D[31:0] and F[3:0] pins (an FPGA, for example). As such, the AD9914 provides an option that makes the internal SYNC_CLK signal externally available at the SYNC_CLK pin. Program CFR2[11] = 1 (default) to make the internal SYNC_CLK signal appear at the SYNC_CLK pin. The user also has the option to invert the external SYNC_CLK signal via CFR2[10].

Enabling the SYNC_CLK pin driver to provide an external replica of the SYNC_CLK signal results in transient current spikes associated with the edges of the SYNC_CLK signal. As such, the SYNC_CLK driver is, by design, a weak CMOS driver. The use of a weak driver limits the magnitude of the current spikes and mitigates their coupling onto sensitive analog nodes within the AD9914.

Note the SYNC_CLK signal of the AD9914 has a nominal duty cycle of 1/3 (~33%). The low duty cycle of the SYNC_CLK signal combined with the limited drive capability of the SYNC_CLK pin driver means that any interface circuitry must exhibit a high input impedance. The recommendation is to use the shortest possible trace length with minimal parasitic capacitive loading when connecting to a receiving circuit.

PROGRAMMABLE MODULUS MODE

In programmable modulus mode, the DRG is used as an auxiliary accumulator to alter the frequency equation of the DDS core, making it possible to implement fractions that are not restricted to a power of 2 in the denominator. A standard DDS is restricted to fractions with a power of 2 in the denominator because the phase accumulator is a set of bits as wide as the frequency tuning word (FTW).

When in programmable modulus mode, however, the frequency equation is:

$$f_0 = (f_S)(FTW + A/B)/2^{32}$$

where $f_0/f_S < 1/2$, $0 \leq FTW < 2^{31}$, $2 \leq B \leq 2^{32} - 1$, and $A < B$.

This equation implies a modulus of $B \times 2^{32}$ (rather than 2^{32} , in the case of a standard DDS). Furthermore, because B is programmable, the result is a DDS with a programmable modulus.

When in programmable modulus mode, the 32-bit auxiliary accumulator operates in a way that allows it to roll over at a value other than the full capacity of 2^{32} . That is, it operates with a modified modulus based on the programmable value of B. With each roll over of the auxiliary accumulator, a value of 1 LSB adds to the current accumulated value of the 32-bit phase accumulator. This

behavior changes the modulus of the phase accumulator to $B \times 2^{32}$ (instead of 2^{32}), allowing it to synthesize the desired f_0 .

To determine the programmable modulus mode register values for FTW, A, and B, the user must first define f_0/f_S as a ratio of relatively prime integers, M/N. That is, having converted f_0 and f_S to integers, M and N, reduce the fraction, M/N, to the lowest terms. Then, divide $M \times 2^{32}$ by N. The integer part of this division operation is the value of FTW (Register 0x04[31:0]). The remainder, Y, of this division operation is

$$Y = (2^{32} \times M) - (FTW \times N)$$

The value of Y facilitates the determination of A and B by taking the fraction, Y/N, and reducing it to the lowest terms. Then, the numerator of the reduced fraction is A (Register 0x06[31:0]) and the denominator is B (Register 0x05[31:0]).

For example, synthesizing precisely 300 MHz with a 1 GHz system clock is not possible with a standard DDS. It is possible, however, using programmable modulus as follows.

First, express f_0/f_S as a ratio of integers:

$$300,000,000/1,000,000,000$$

Reducing this fraction to lowest terms yields 3/10; therefore, M = 3 and N = 10. FTW is the integer part of $(M \times 2^{32})/N$, or $(3 \times 2^{32})/10$, which is 1,288,490,188 (0x4CCCCCCC in 32-bit hexadecimal notation). The remainder, Y, of $(3 \times 2^{32})/10$, is $(2^{32} \times 3) - (1,288,490,188 \times 10)$, which is 8. Therefore, Y/N is 8/10, which reduces to 4/5. Therefore, A = 4 and B = 5 (0x00000004 and 0x00000005 in 32-bit hexadecimal notation, respectively). Programming the AD9914 with these values of FTW, A, and B results in an output frequency that is exactly 3/10 of the system clock frequency.

MODE PRIORITY

The ability to activate each mode independently makes it possible to have multiple data sources attempting to drive the same DDS signal control parameter (frequency, phase, and amplitude). To avoid contention, the AD9914 has a built-in priority system. Table 6 summarizes the priority for each of the DDS modes. The data source column in Table 6 lists data sources for a particular DDS signal control parameter in descending order of precedence. For example, if the profile mode enable bit and the parallel data port enable bit (0x01[23:22]) are set to Logic 1 and both are programmed to source the frequency tuning word to DDS output, the profile modulation mode has priority over the parallel data port modulation mode.

Table 6. Data Source Priority

DDS Signal Control Parameters		
Priority	Data Source	Conditions
Highest Priority	Programmable modulus	If programmable modulus mode is used to output frequency only, no other data source can control the output frequency in this mode. Note that the DRG is used in conjunction with programmable modulus mode; therefore, the DRG cannot be used to sweep phase or amplitude in programmable modulus mode.

THEORY OF OPERATION

Table 6. Data Source Priority

DDS Signal Control Parameters		
Priority	Data Source	Conditions
Lowest Priority		If output phase offset control is desired, enable profile mode and use the profile registers and profile pins accordingly to control output phase adjustment.
		If output amplitude control is desired, enable profile mode and use the profile registers and profile pins accordingly to control output amplitude adjustment. Note that the OSK enable bit must be set to control the output amplitude.
	DRG	The digital ramp modulation mode is the next highest priority mode. If the DRG is enabled to sweep output frequency, phase, or amplitude, the two parameters not being swept can be controlled independently via the profile mode.
	Profiles	The profile modulation mode is the next highest priority mode. Profile mode can control all three parameters independently, if desired.
	Parallel port	Parallel data port modulation has the lowest priority but the most flexibility as far as changing any parameter at the high rate. See the Programming and Function Pins section.

FUNCTIONAL BLOCK DETAIL

DDS CORE

The direct digital synthesizer (DDS) block generates a reference signal (sine or cosine based on Register 0x00, Bit 16, the enable sine output bit). The parameters of the reference signal (frequency, phase, and amplitude) are applied to the DDS at the frequency, phase offset, and amplitude control inputs, as shown in Figure 31.

The output frequency (f_{OUT}) of the AD9914 is controlled by the frequency tuning word (FTW) at the frequency control input to the DDS. The relationship among f_{OUT} , FTW, and f_{SYSCLK} is given by

$$f_{OUT} = \left(\frac{FTW}{2^{32}}\right)f_{SYSCLK} \tag{1}$$

where FTW is a 32-bit integer ranging in value from 0 to 2,147,483,647 ($2^{31} - 1$), which represents the lower half of the full 32-bit range. This range constitutes frequencies from dc to Nyquist (that is, $\frac{1}{2} f_{SYSCLK}$).

The FTW required to generate a desired value of f_{OUT} is found by solving Equation 1 for FTW, as given in Equation 2.

$$FTW = \text{round}\left(2^{32}\left(\frac{f_{OUT}}{f_{SYSCLK}}\right)\right) \tag{2}$$

where the round(x) function rounds the argument (the value of x) to the nearest integer. This is required because the FTW is constrained to be an integer value. For example, for $f_{OUT} = 41$ MHz and $f_{SYSCLK} = 122.88$ MHz, $FTW = 1,433,053,867$ (0x556AAAAB).

Programming an FTW greater than 2^{31} produces an aliased image that appears at a frequency given by

$$f_{OUT} = \left(1 - \frac{FTW}{2^{32}}\right)f_{SYSCLK}$$

for $FTW \geq 2^{31}$.

The relative phase of the DDS signal can be digitally controlled by means of a 16-bit phase offset word (POW). The phase offset is

applied prior to the angle to amplitude conversion block internal to the DDS core. The relative phase offset ($\Delta\theta$) is given by

$$\Delta\theta = \begin{cases} 2\pi\left(\frac{POW}{2^{16}}\right) \\ 360\left(\frac{POW}{2^{16}}\right) \end{cases}$$

where the upper quantity is for the phase offset expressed as radian units and the lower quantity as degrees.

To find the POW value necessary to develop an arbitrary $\Delta\theta$, solve the preceding equation for POW and round the result (in a manner similar to that described previously for finding an arbitrary FTW).

The relative amplitude of the DDS signal can be digitally scaled (relative to full scale) by means of a 12-bit amplitude scale factor (ASF). The amplitude scale value is applied at the output of the angle to amplitude conversion block internal to the DDS core. The amplitude scale is given by

$$\text{Amplitude Scale} = \begin{cases} \frac{ASF}{2^{12}} \\ 20\log\left(\frac{ASF}{2^{12}}\right) \end{cases} \tag{3}$$

where the upper quantity is amplitude expressed as a fraction of full scale and the lower quantity is expressed in decibels relative to full scale.

To find the ASF value necessary for a particular scale factor, solve Equation 3 for ASF and round the result (in a manner similar to that described previously for finding an arbitrary FTW).

When the AD9914 is programmed to modulate any of the DDS signal control parameters, the maximum modulation sample rate is $\frac{1}{24} f_{SYSCLK}$. This means that the modulation signal exhibits images at multiples of $\frac{1}{24} f_{SYSCLK}$. The impact of these images must be considered when using the device as a modulator.

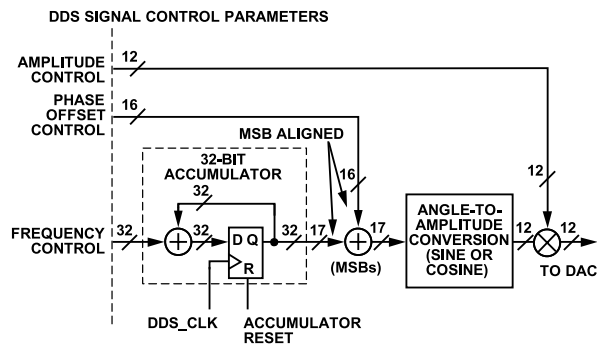

Figure 31. DDS Block Diagram

FUNCTIONAL BLOCK DETAIL

12-BIT DAC OUTPUT

The AD9914 incorporates an integrated 12-bit, current output DAC. The output current is delivered as a balanced signal using two outputs. The use of balanced outputs reduces the potential amount of common-mode noise present at the DAC output, offering the advantage of an increased signal-to-noise ratio. An external resistor (R_{SET}) connected between the DAC_RSET pin and AGND establishes the reference current. The recommended value of R_{SET} is 3.3 k Ω .

Attention must be paid to the load termination to keep the output voltage within the specified compliance range; voltages developed beyond this range cause excessive distortion and can damage the DAC output circuitry.

DAC CALIBRATION OUTPUT

The DAC CAL enable bit in the CFR4 control register (0x03[24]) must be manually set and then cleared after each power-up and every time the REF CLK or internal system clock is changed. This initiates an internal calibration routine to optimize the setup and hold times for internal DAC timing. Failure to calibrate may degrade performance and even result in loss of functionality. The length of time to calibrate the DAC clock is calculated from the following equation:

$$t_{CAL} = \frac{469,632}{f_S}$$

RECONSTRUCTION FILTER

The DAC output signal appears as a sinusoid sampled at f_S . The frequency of the sinusoid is determined by the frequency tuning word (FTW) that appears at the input to the DDS. The DAC output

is typically passed through an external reconstruction filter that serves to remove the artifacts of the sampling process and other spurs outside the filter bandwidth.

Because the DAC constitutes a sampled system, the output must be filtered so that the analog waveform accurately represents the digital samples supplied to the DAC input. The unfiltered DAC output contains the desired baseband signal, which extends from dc to the Nyquist frequency ($f_S/2$). It also contains images of the baseband signal that theoretically extend to infinity. Notice that the odd numbered images (shown in Figure 32) are mirror images of the baseband signal. Furthermore, the entire DAC output spectrum is affected by a $\sin(x)/x$ response, which is caused by the sample-and-hold nature of the DAC output signal.

For applications using the fundamental frequency of the DAC output, the response of the reconstruction filter must preserve the baseband signal (Image 0), while completely rejecting all other images. However, a practical filter implementation typically exhibits a relatively flat pass band that covers the desired output frequency followed by a transition band where the response rolls off as steeply as possible, and then a stop band that maintains significant (though not complete) rejection of the remaining images. Depending on how close unwanted spurs are to the desired signal, a third-, fifth-, or seventh-order elliptic low-pass filter is common.

Some applications operate from an image above the Nyquist frequency, and those applications use a band-pass filter instead of a low-pass filter. The design of the reconstruction filter has a significant impact on the overall signal performance. Therefore, good filter design and implementation techniques are important for obtaining the best possible jitter results.

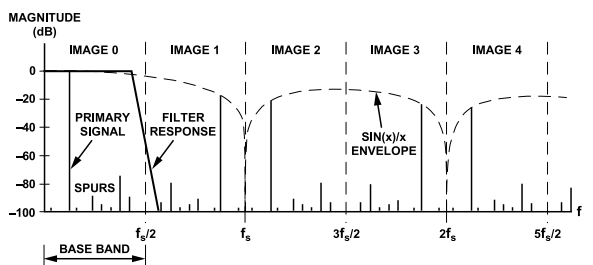

Figure 32. DAC Spectrum vs. Reconstruction Filter Response

FUNCTIONAL BLOCK DETAIL

CLOCK INPUT (REF_CLK/REF_CLK)

REF_CLK/REF_CLK Overview

The AD9914 supports a number of options for producing the internal SYSCLK signal (that is, the DAC sample clock) via the REF_CLK/REF_CLK input pins. The REF_CLK input can be driven directly from a differential or single-ended source. There is also an internal phase-locked loop (PLL) multiplier that can be independently enabled. However, the PLL limits the SYSCLK signal between 2.4 GHz and 2.5 GHz operation. A differential signal is recommended when the PLL is bypassed. A block diagram of the REF_CLK functionality is shown in Figure 33. Figure 33 also shows how the CFR3 control bits are associated with specific functional blocks.

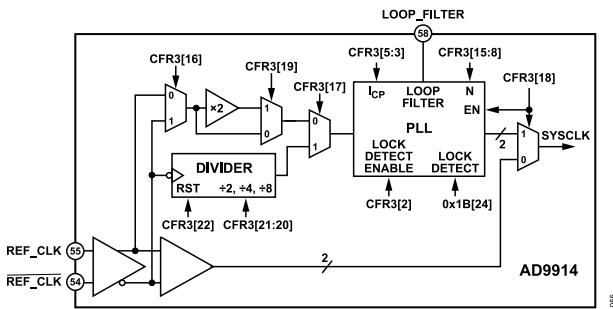

Figure 33. REF_CLK Block Diagram

The PLL enable bit (0x02[18]) chooses between the PLL path and the direct input path. The direct input path is the default condition. When the direct input path is selected, the REF_CLK/REF_CLK pins must be driven by an external signal source (single-ended or differential). Input frequencies up to 3.5 GHz are supported.

Direct Driven REF_CLK/REF_CLK

With a differential signal source, the REF_CLK/REF_CLK pins are driven with complementary signals and ac-coupled with 0.1 μ F capacitors. With a single-ended signal source, either a single-ended-to-differential conversion can be employed or the REF_CLK input can be driven single-ended directly. In either case, 0.1 μ F capacitors ac couples both REF_CLK/REF_CLK pins to avoid disturbing the 2 V dc internal bias voltage. See Figure 34 for more details.

The REF_CLK/REF_CLK input resistance is ~ 2.5 k Ω differential (~ 1.2 k Ω single-ended). Most signal sources have relatively low output impedances. The REF_CLK/REF_CLK input resistance is relatively high; therefore, the effect on the termination impedance is negligible and can usually be chosen to be the same as the output impedance of the signal source. The bottom two examples in Figure 34 assume a signal source with a 50 Ω output impedance.

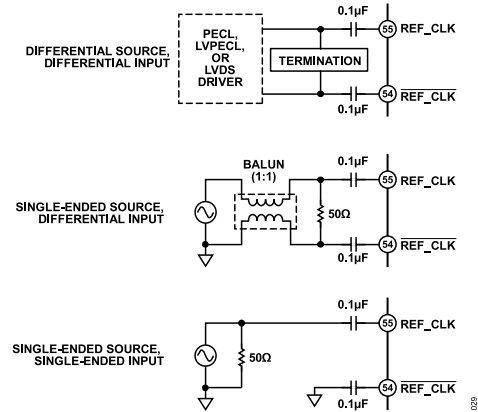

Figure 34. Direct Connection Diagram

Phase-Locked Loop (PLL) Multiplier

An internal PLL provides the option to use a reference clock frequency that is significantly lower than the system clock frequency. The PLL supports a wide range of programmable even frequency multiplication factors ($20\times$ to $510\times$; that is, two times the programmed value of N (CFR3[15:8])) as well as a programmable charge pump current and external loop filter components (connected via the PLL LOOP_FILTER pin). These features add an extra layer of flexibility to the PLL, allowing optimization of phase noise performance and flexibility in frequency plan development. The PLL is also equipped with a lock detector, enabled via CFR3[2] = 1. When enabled, lock detect status is available via 0x1B[24].

The PLL output frequency range (f_{SYSCLK}) is constrained to the range of $2.4 \text{ GHz} \leq f_{\text{SYSCLK}} \leq 2.5 \text{ GHz}$ by the internal VCO.

As shown in Figure 33, to use the PLL, the user must program CFR3[18] = 1, which enables the PLL circuitry and selects the VCO output of the PLL as the internal system clock (SYSCLK) source. There are three ways to route the REF_CLK input signal to the input of the PLL, as follows:

- ▶ Feedthrough (PLL input frequency = REF_CLK input frequency)
- ▶ Divided (PLL input frequency = REF_CLK input frequency divided by 2, 4, or 8)
- ▶ Multiplied (PLL input frequency = twice the REF_CLK input frequency)

Regardless of the routing option chosen, the user must ensure the frequency at the input to the PLL does not exceed 125 MHz.

The feedthrough path is the default PLL input option (in effect when CFR3[17] = 0 and CFR3[19] = 0). Because the feedthrough path delivers the REF_CLK input signal to the PLL input without frequency division or multiplication, the PLL can be made to align with either the rising or falling edge of the REF_CLK input signal via CFR3[16]. Logic 0 selects the rising edge of the REF_CLK input signal, whereas Logic 1 selects the falling edge. Normally, there is no particular advantage over choosing one edge over the other. However, some clock sources exhibit more jitter on one edge than

FUNCTIONAL BLOCK DETAIL

the other. Thus, the ability to choose the edge with less jitter yields less noise.

The divided path is in effect when $CFR3[17] = 1$ (the state of $CFR3[16]$ and $CFR3[19]$ is immaterial). The user has four options via $CFR3[21:20]$: disable the divider or divide by 2, 4 or 8. Note that the divided path uses the inverted version of the REF_CLK input signal exclusively.

The multiplied path is in effect when $CFR3[19] = 1$ and $CFR3[17] = 0$, which doubles the frequency of the REF_CLK input before delivering it to the input of the PLL.

VCO Calibration

When using the PLL to generate the system clock, VCO calibration is required to tune the VCO appropriately and achieve good performance. When the reference input signal is stable, the VCO cal enable bit in the CFR1 register, $0x00[24]$, must be asserted. Subsequent VCO calibrations require that the VCO calibration bit be cleared prior to initiating another VCO calibration. VCO calibration must occur before DAC calibration to ensure optimal performance and functionality.

PLL Charge Pump/Total Feedback Divider

The charge pump current (I_{CP}) value is automatically chosen via the VCO calibration process and N value ($N = 10$ to 255) stored in Feedback Divider $N[7:0]$ in the CFR3 register ($0x02[15:8]$). N values below 10 must be avoided.

Note that the total PLL multiplication value for the PLL is always $2N$ due to the fixed divide by 2 element in the feedback path. This is shown in Figure 35. This fixed divide by 2 element forces only even PLL multiplication.

To manually override the charge pump current value, the manual I_{CP} selection bit in CFR3 ($0x02[6]$) must be set to Logic 1. This provides the user with additional flexibility to optimize the PLL performance. Table 7 lists the bit settings vs. the nominal charge pump current.

Table 7. PLL Charge Pump Current

I_{CP} Bits (CFR3[5:3])	Charge Pump Current, I_{CP} (μA)
000	125
001	250
010	375
011	500 (default)
100	625
101	750
110	875
111	1000

Table 8. N Divider vs. Charge Pump Current

N Divider Range	Recommended Charge Pump Current, I_{CP} (μA)
10 to 15	125

Table 8. N Divider vs. Charge Pump Current

N Divider Range	Recommended Charge Pump Current, I_{CP} (μA)
16 to 23	250
24 to 35	375
36 to 43	500
44 to 55	625
56 to 63	750
64 to 79	875
80 to 100	1000

PLL Loop Filter Components

The loop filter is mostly internal to the device, as shown in Figure 35. The recommended external capacitor value is 560 pF. Because C_P and R_{PZ} are integrated, it is not recommended to adjust the loop bandwidth via the external capacitor value. The better option is to adjust the charge pump current even though it is a coarse adjustment.

For example, suppose the PLL is manually programmed such that $I_{CP} = 375 \mu A$, $K_V = 60 \text{ MHz/V}$, and $N = 25$. This produces a loop bandwidth of approximately 250 kHz.

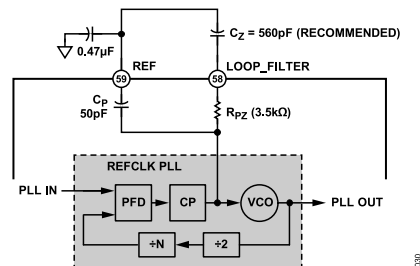

Figure 35. REF CLK PLL External Loop Filter

PLL Lock Indication

When the PLL is in use and $CFR3[2] = 1$, the PLL lock bit ($0x1B[24]$) provides an active high indication that the PLL has locked to the REF_CLK input signal.

OUTPUT SHIFT KEYING (OSK)

The OSK function (see Figure 36) allows the user to control the output signal amplitude of the DDS. The amplitude data generated by the OSK block has priority over any other functional block that is programmed to deliver amplitude data to the DDS. Therefore, the OSK data source, when enabled, overrides all other amplitude data sources.

The operation of the OSK function is governed by two CFR1 register bits, OSK enable ($0x00[8]$) and external OSK enable ($0x00[9]$), the external OSK pin, the profile pins, and the 12 bits of amplitude scale factor found in one of eight profile registers. The profile pins select the profile register containing the desired amplitude scale factor.

FUNCTIONAL BLOCK DETAIL

The primary control for the OSK block is the OSK enable bit (0x00[8]). When the OSK function is disabled, the OSK input controls and OSK pin are ignored.

The OSK pin functionality depends on the state of the external OSK enable bit and the OSK enable bit. When both bits are set to Logic 1 and the OSK pin is Logic 0, the output amplitude is forced to 0; otherwise, if the OSK pin is Logic 1, the output amplitude is set by the amplitude scale factor value in one of eight profile registers depending on the profile pin selection.

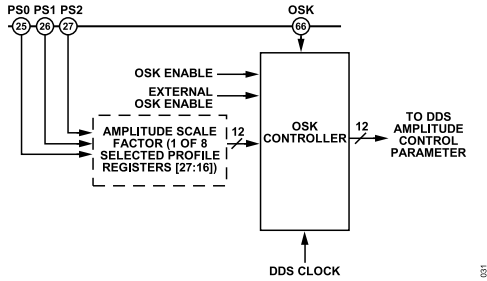

Figure 36. OSK Block Diagram

DIGITAL RAMP GENERATOR (DRG)

DRG Overview

To sweep phase, frequency, or amplitude from a defined start point to a defined endpoint, a completely digital ramp generator is included in the AD9914. The DRG makes use of eight control register bits, three external pins, and five 32-bit registers (see Figure 37).

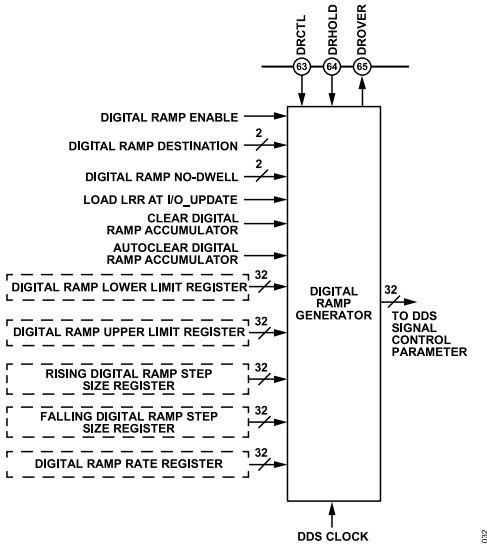

Figure 37. Digital Ramp Block Diagram

The primary control for the DRG is the digital ramp enable bit (0x01[19]). When disabled, the other DRG input controls are ignored and the internal clocks are shut down to conserve power.

The output of the DRG is a 32-bit unsigned data bus that can be routed to any one of the three DDS signal control parameters, as controlled by the two digital ramp destination bits in Control Function Register 2 according to Table 9. The 32-bit output bus is LSB-aligned with the 32-bit frequency parameter, the 16-bit phase parameter, or the 12-bit amplitude parameter, as defined by the destination bits. When the destination is phase or amplitude, the unused MSBs are ignored.

Table 9. Digital Ramp Destination

Digital Ramp Destination Bits (CFR2[21:20])	DDS Signal Control Parameter	Allocation of the DDS Parameter Bits in the 32-Bit DRG Output Bus
00	Frequency	31:0
01	Phase	15:0
1x ¹	Amplitude	11:0

¹ x = don't care.

The ramp characteristics of the DRG are fully programmable. This includes the upper and lower ramp limits, and independent control of the step size and step rate for both the positive and negative slope characteristics of the ramp. A detailed block diagram of the DRG is shown in Figure 38.

The direction of the ramping function is controlled by the DRCTL pin. The DRG responds differently to the DRCTL pin depending on the state of the two no-dwell bits (CFR2[18:17]) per Table 10.

The DRG also supports a hold feature controlled via the DRHOLD pin. When this pin is set to Logic 1, the DRG is stalled at the last state; otherwise, the DRG operates normally. The DDS signal control parameters that are not the destination of the DRG are taken from the active profile.

Table 10. DRCTL Pin Functionality

CFR2[18]	CFR2[17]	Dwell Type	DRCTL Pin Behavior
0	0	Hold upper (lower) frequency limit at end of rising (falling) ramp	Level sensitive. Logic 0 on the DRCTL pin causes the DRG to initiate a falling ramp, whereas Logic 1 causes the DRG to initiate a rising ramp.

FUNCTIONAL BLOCK DETAIL

Table 10. DRCTL Pin Functionality

CFR2[18]	CFR2[17]	Dwell Type	DRCTL Pin Behavior
0	1	Return to upper frequency limit at end of falling ramp	Edge sensitive. A Logic 1 to Logic 0 transition on the DRCTL pin causes the DRG to initiate a negative slope ramp, which continues uninterrupted (regardless of any further activity on the DRCTL pin) until the lower limit is reached.
1	0	Return to lower frequency limit at end of rising ramp	Edge sensitive. A Logic 0 to Logic 1 transition on the DRCTL pin causes the DRG to initiate a positive slope ramp, which continues uninterrupted (regardless of any further activity on the DRCTL pin) until the upper limit is reached.
1	1	Continuous rising and falling ramp	Edge sensitive. During a positive slope ramp, a Logic 1 to Logic 0 transition on the DRCTL pin causes the DRG to immediately change the ramp direction to a negative slope using the negative slope parameters. During a negative slope ramp, a Logic 0 to Logic 1 transition on the DRCTL pin causes the DRG to immediately change the ramp direction to a positive slope using the positive slope parameters.

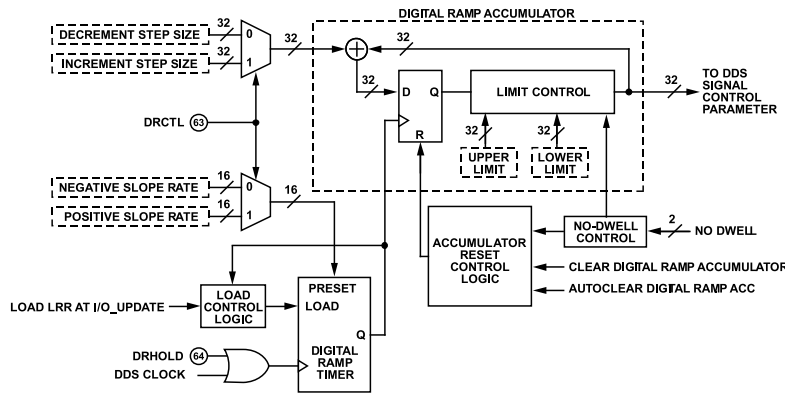

Figure 38. Digital Ramp Generator Detail

DRG Slope Control

The core of the DRG is a 32-bit accumulator clocked by a programmable timer. The time base for the timer is the DDS clock, which operates at $1/24 f_{SYSCLK}$. The timer establishes the interval between successive updates of the accumulator. The positive ($+\Delta t$) and negative ($-\Delta t$) slope step intervals are independently programmable as given by

$$+\Delta t = \frac{24P}{f_{SYSCLK}}$$

$$-\Delta t = \frac{24N}{f_{SYSCLK}}$$

where P and N are the two 16-bit values stored in the 32-bit digital ramp rate register and control the step interval. N defines the step interval of the negative slope portion of the ramp. P defines the step interval of the positive slope portion of the ramp.

The step size of the positive ($STEP_P$) and negative ($STEP_N$) slope portions of the ramp are 32-bit values programmed into the 32-bit rising and falling digital ramp step size registers (0x06 and 0x07). Program each of the step sizes as an unsigned integer (the hardware automatically interprets $STEP_N$ as a negative value). The relationship between the 32-bit step size values and actual units of frequency, phase, or amplitude depend on the digital ramp destination bits. Calculate the actual frequency, phase, or amplitude

step size by substituting $STEP_N$ or $STEP_P$ for M in the following equations as required:

$$Frequency\ Step = \left(\frac{M}{2^{32}}\right) f_{SYSCLK}$$

$$Phase\ Step = \frac{\pi M}{2^{15}} \text{ (radians)}$$

$$Phase\ Step = \frac{45M}{2^{13}} \text{ (degrees)}$$

$$Amplitude\ Step = \left(\frac{M}{2^{12}}\right) I_{FS}$$

Note that the frequency units are the same as those that represent f_{SYSCLK} (MHz, for example). The amplitude units are the same as those that represent I_{FS} , the full-scale output current of the DAC (mA, for example).

Although the sweep accumulator has 32 bits of resolution, phase and amplitude sweeps make use of the 16 LSBs or 12 LSBs of the sweep accumulator, respectively. Thus, the phase step equations and the amplitude step equation reflect 16-bit or 12-bit resolution, accordingly. As such, when programming the associated step size registers for phase or amplitude sweeps, the user must ensure the 16 MSBs or 20 MSBs, respectively, are programmed with zeros.

FUNCTIONAL BLOCK DETAIL

As described previously, the step interval is controlled by a 16-bit programmable timer. There are three events that can cause this timer to be reloaded prior to the expiration, as follows:

- ▶ A transition of the digital ramp enable bit from cleared to set, followed by assertion of the IO_UPDATE pin
- ▶ A change of state of the DRCTL pin
- ▶ Anytime the IO_UPDATE pin is asserted while the load LRR at input/output update bit is set (0x00[15] = 1)

DRG Limit Control

The ramp accumulator is followed by limit control logic that enforces an upper and lower boundary on the output of the ramp generator. Under no circumstances does the output of the DRG exceed the programmed limit values while the DRG is enabled. The limits are set through the 64-bit digital ramp limit register, comprising a 32-bit upper limit value and a 32-bit lower limit value. Note that the upper limit value must be greater than the lower limit value to ensure normal operation.

For a phase sweep, program the 16 LSBs of the 32-bit upper limit and lower limit registers with the desired phase value and program the 16 MSBs of the upper limit and lower limit registers with zeros. For an amplitude sweep, program the 12 LSBs of the 32-bit upper limit and lower limit registers with the desired amplitude value and the 20 MSBs of the upper limit and lower limit registers with zeros.

DRG Accumulator Clear

The ramp accumulator can be cleared (that is, reset to 0) under program control. When the ramp accumulator is cleared, it forces the DRG output to the lower limit programmed into the digital ramp limit register.

With the limit control block embedded in the feedback path of the accumulator, resetting the accumulator is equivalent to presetting it to the lower limit value.

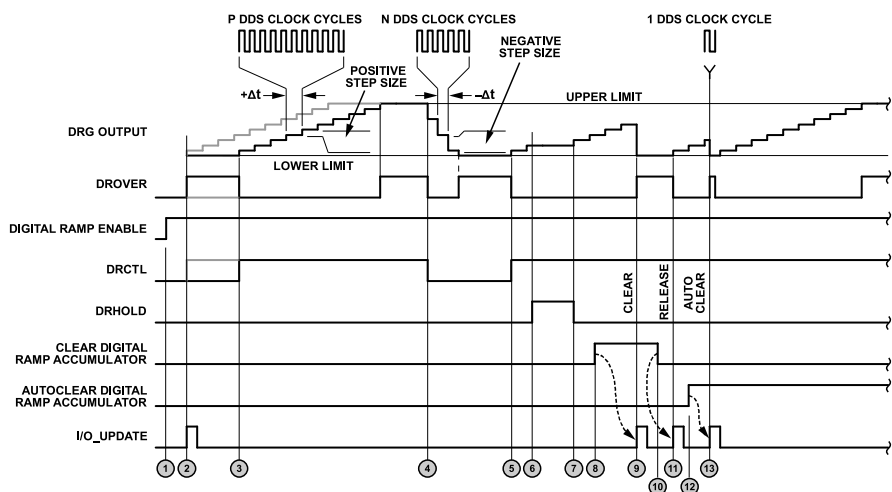

Figure 39. Normal Ramp Generation

FUNCTIONAL BLOCK DETAIL

Normal Ramp Generation

Normal ramp generation implies that both no-dwell bits are cleared (see the [No-Dwell Ramp Generation](#) section for details). In [Figure 39](#), a sample ramp waveform is depicted with the required control signals. The top trace is the DRG output. The next trace down is the status of the DROVER output pin (assuming that the DRG over output enable bit is set). The remaining traces are control bits and control pins. The pertinent ramp parameters are also identified (upper and lower limits plus step size and Δt for the positive and negative slopes). Along the bottom, circled numbers identify specific events. These events are referred to by number (Event 1 and so on) in the following paragraphs.

In this example, the positive and negative slopes of the ramp are different to demonstrate the flexibility of the DRG. The parameters of both slopes can be programmed to make the positive and negative slopes the same.

Event 1—The digital ramp enable bit is set, which has no effect on the DRG output because the bit is not effective until an input/output update occurs.

Event 2—An input/output update registers the digital ramp enable bit. If DRCTL = 1 is in effect (the gray portion of the DRCTL trace), the DRG output immediately begins a positive slope (the gray portion of the DRG output trace). Otherwise, if DRCTL = 0, the DRG output is initialized to the lower limit.

Event 3—DRCTL transitions to Logic 1 to initiate a positive slope at the DRG output. In this example, the DRCTL pin is held long enough to cause the DRG to reach the programmed upper limit. The DRG remains at the upper limit until the ramp accumulator is cleared (DRCTL = 0) or the upper limit is reprogrammed to a higher value. In the latter case, the DRG immediately resumes the previous positive slope profile.

Event 4—DRCTL transitions to Logic 0 to initiate a negative slope at the DRG output. In this example, the DRCTL pin is held long enough to cause the DRG to reach the programmed lower limit. The DRG remains at the lower limit until DRCTL = 1, or until the lower limit is reprogrammed to a lower value. In the latter case, the DRG immediately resumes the previous negative slope profile.

Event 5—DRCTL transitions to Logic 1 for the second time, initiating a second positive slope.

Event 6—The positive slope profile is interrupted by DRHOLD transitioning to Logic 1. This stalls the ramp accumulator and freezes the DRG output at the last value.

Event 7—DRHOLD transitions to Logic 0, releasing the ramp accumulator and reinstating the previous positive slope profile.

Event 8—The clear digital ramp accumulator bit is set, which has no effect on the DRG because the bit is not effective until an input/output update is issued.

Event 9—An input/output update registers that the clear digital ramp accumulator bit is set, resetting the ramp accumulator and forcing the DRG output to the programmed lower limit. The DRG output remains at the lower limit until the clear condition is removed.

Event 10—The clear digital ramp accumulator bit is cleared, which has no effect on the DRG output because the bit is not effective until an input/output update is issued.

Event 11—An input/output update registers that the clear digital ramp accumulator bit is cleared, releasing the ramp accumulator; and the previous positive slope profile restarts.

Event 12—The autoclear digital ramp accumulator bit is set, which has no effect on the DRG output because the bit is not effective until an input/output update is issued.

Event 13—An input/output update registers that the autoclear digital ramp accumulator bit is set, resetting the ramp accumulator. However, with an automatic clear, the ramp accumulator is held in reset for only a single DDS clock cycle. This forces the DRG output to the lower limit, but the ramp accumulator is immediately made available for normal operation. In this example, the DRCTL pin remains Logic 1; therefore, the DRG output restarts the previous positive ramp profile.

No-Dwell Ramp Generation

The no-dwell high and no-dwell low bits (0x01[18:17]) add to the flexibility of the DRG capabilities. During normal (default) ramp generation, when the DRG output reaches the programmed upper or lower limit, it simply remains at the limit until the operating parameters dictate otherwise. However, during no-dwell operation, the DRG output does not necessarily remain at the limit. For example, during no-dwell high operation (0x01[18:17] = 10 (binary)), when the DRG reaches its upper limit, the DRG immediately snaps to the lower limit and halts. Likewise, during no-dwell low operation (0x01[18:17] = 01 (binary)), when the DRG reaches its lower limit, the DRG immediately snaps to the upper limit and halts. Alternatively, a continuous ramping mode is in effect when 0x01[18:17] = 11 (binary), in which case the DRG output automatically oscillates between the upper and lower limits using the programmed slope parameters.

Note that in continuous ramping mode, the DROVER signal operates differently than in dwell operation. In dwell operation, the DROVER signal assumes a static Logic 1 state indicating the end of the sweep. In continuous ramping mode, however, the DROVER signal is a positive pulse (with a period of two cycles of the DDS clock) that occurs each time the DRG output reaches either of the programmed limits (assuming that the DRG over output enable bit (0x01[13]) is set).

A no-dwell high DRG output waveform is shown in [Figure 40](#). The waveform diagram assumes that the digital ramp no-dwell high bit is set and has been registered by an input/output update. The

FUNCTIONAL BLOCK DETAIL

status of the DROVER pin is also shown with the assumption that the DRG over output enable bit has been set.

The circled numbers in Figure 40 indicate specific events, which are explained as follows:

Event 1—Indicates the instant that an input/output update registers that the digital ramp enable bit is set.

Event 2—DRCTL transitions to Logic 1, initiating a positive slope at the DRG output.

Event 3—DRCTL transitions to Logic 0, which has no effect on the DRG output.

Event 4—Because the digital ramp no-dwell high bit is set, the moment that the DRG output reaches the upper limit, it immediately switches to the lower limit, where it remains until the next Logic 0 to Logic 1 transition of DRCTL.

Event 5—DRCTL transitions from Logic 0 to Logic 1, which restarts a positive slope ramp.

Event 6 and Event 7—DRCTL transitions are ignored until the DRG output reaches the programmed upper limit.

Event 8—Because the digital ramp no-dwell high bit is set, the moment that the DRG output reaches the upper limit, it immediately switches to the lower limit, where it remains until the next Logic 0 to Logic 1 transition of DRCTL.

Operation with the digital ramp no-dwell low bit set (instead of the digital ramp no-dwell high bit) is similar, except that the DRG output ramps in the negative direction on a Logic 1 to Logic 0 transition of DRCTL and jumps to the upper limit upon reaching the lower limit.

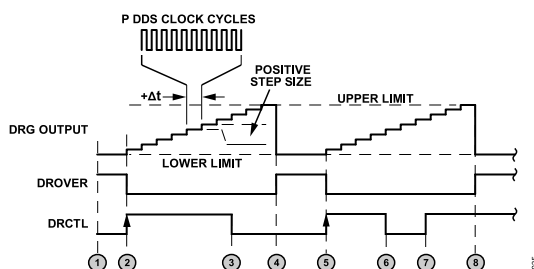

Figure 40. No-Dwell High Ramp Generation

FUNCTIONAL BLOCK DETAIL

DROVER Pin

The DROVER pin provides an external signal to indicate the sweep status of the DRG (assuming the DRG is enabled via $CFR2[19] = 1$ and the DROVER pin is enabled via $CFR2[13] = 1$). The behavior of the DROVER pin depends on the state of the no-dwell bits ($CFR2[17:18]$).

With neither no-dwell bit set (dwell operation), the DROVER pin is Logic 1 whenever the DRG output is at the upper or lower limit (per the prevailing sweep direction). Upon initiation of a new sweep, the DROVER pin switches to Logic 0 until the DRG output again reaches the appropriate limit.

With either (but not both) no-dwell bit set (no-dwell operation), the DROVER pin behavior is the same as for dwell operation. However, the DROVER pin remains Logic 1 even after the DRG returns to the starting point as prescribed by no-dwell operation. Upon initiation of a new sweep, the DROVER pin switches to Logic 0 until the DRG output again reaches the appropriate limit.

With both no-dwell bits set (bidirectional sweep operation), instead of providing a static indication, the DROVER pin generates a positive pulse for two SYNC_CLK clock cycles on the final step the DRG makes to reach either of the programmed limits. That is, a positive pulse is generated each time the DRG output reaches the upper limit and a positive pulse each time the DRG output reaches the lower limit.

Frequency Jumping Capability in DRG Mode

Another feature of the AD9914 allows the user to skip a predefined range of frequencies during a normal sweep. The frequency jump enable bit in $CFR2$ ($0x01[14]$) enables this functionality. When this bit is set, the sweeping logic monitors the instantaneous frequency. For example, during an up sweep, when the sweeping logic detects that the next output of the DRG sweep accumulator is equal or exceed the frequency point defined in the lower frequency jump register ($0x09$), instead of accumulating a delta tuning word (as in normal sweeping), the output of the DRG sweep accumulator skips directly to the frequency value set in the upper frequency jump register ($0x0A$), and vice versa for a down sweep. [Figure 41](#) is a frequency vs. time profile depicting an example of the behavior of the frequency jump feature.

A second frequency jump can also be allowed if the frequency jump registers are reprogrammed before the sweeping is complete.

The following rules apply when this feature is enabled:

- ▶ The frequency jump feature requires that P and N (see the [DRG Slope Control](#) section) be greater than 2.
- ▶ The frequency jump values must lie between the lower limit and upper limit of the frequency sweep range.
- ▶ The value stored in the lower frequency jump register must be less than the value stored in the upper frequency jump register.

- ▶ Setting both no-dwell bits ($0x01[18:17]$) to Logic 1 disables the frequency jump feature.

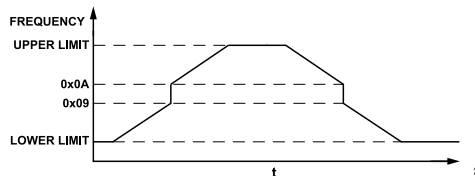

Figure 41. Frequency vs. Time

POWER-DOWN CONTROL

The AD9914 offers the ability to independently power down three specific sections of the device. Power-down functionality applies to the following:

- ▶ Digital core
- ▶ DAC
- ▶ Input REF CLK clock circuitry

A power-down of the digital core disables the ability to update the serial/parallel input/output port. However, the digital power-down bit ($0x00[7]$) can still be cleared to prevent the possibility of a nonrecoverable state.

Software power-down is controlled via three independent power-down bits in $CFR1$. Software control requires that the EXT_PWR_DWN pin be forced to a Logic 0 state. In this case, setting the desired power-down bits ($0x00[7:5]$) via the serial input/output port powers down the associated functional block, whereas clearing the bits restores the function.

Alternatively, all three functions can be simultaneously powered down via external hardware control through the EXT_PWR_DWN pin. When this pin is forced to Logic 1, all four circuit blocks are powered down regardless of the state of the power-down bits; that is, the independent power-down bits in $CFR1$ are ignored and overridden when EXT_PWR_DWN is Logic 1.

The type of power-down activated by asserting the EXT_PWR_DWN pin depends on the state of $CFR1[3]$. When $CFR1[3] = 1$ (default), assertion of the EXT_PWR_DWN pin activates full power-down mode. As such, deasserting the EXT_PWR_DWN pin necessitates DAC calibration and, if the PLL is enabled, VCO calibration, as well. Alternatively, when $CFR1[3] = 0$, assertion of the EXT_PWR_DWN pin activates fast recovery power-down mode. Fast recovery power-down mode maintains power to the DAC bias circuitry, the PLL, VCO, and input clock circuitry. Because the DAC, input clock circuitry, and PLL remain active in fast recovery power-down mode, it is not necessary to perform DAC or VCO calibration after deasserting the EXT_PWR_DWN pin when $CFR1[3] = 0$. Although fast recovery power-down mode offers only incremental power savings compared to full power-down mode, fast recovery power-down mode allows the device to awaken from the power-down state very quickly.

FUNCTIONAL BLOCK DETAIL

Fast recovery power-down is especially beneficial when using the PLL, because the PLL remains locked to the input reference signal even while the EXT_PWR_DWN pin is asserted. Note that while the EXT_PWR_DWN pin is asserted in fast recovery power-down mode, the DAC is not fully asleep and may exhibit unspecified signal or noise at the output. Therefore, applications that require a quiet DAC output during fast recovery power-down must include external circuitry to mute the DAC output during power-down.

PROGRAMMING AND FUNCTION PINS

The AD9914 is equipped with a 32-bit parallel port. The 32-bit port is for programming the internal registers of the device in either serial mode or parallel mode as well as allowing for direct modulation control of frequency (FTW), phase (POW), and amplitude (AMP).

The state of the external function pins (F0 to F3) determines how the 32-bit parallel port is configured. Pin 28 to Pin 31 are the function pins. Refer to [Table 11](#) for possible configurations.

Note that the OSK enable bit, CFR1[8], must be set to enable amplitude control, as shown in [Table 11](#).

Table 11. Parallel Port Configurations

Function Pins, F[3:0] ¹	Mode Description	32-Bit Parallel Port Pin Assignment			
		Bits[31:24] ²	Bits[23:16] ³	Bits[15:8] ⁴	Bits[7:0] ⁵
0000	Parallel programming mode	Data[15:8] (optional)	Data[7:0]	Address[7:0]	Controls writes, reads, and 8-bit or 16-bit data-word. See the Parallel Programming (8-/16-Bit) section for details.
0001	Serial programming mode	Not used	Not used	Not used	Controls SCLK, SDIO, SDO, \overline{CS} , and SYNCIO. See the Serial Programming section for details.
0010	Full 32 bits of direct frequency tuning word control. MSB and LSB aligned to parallel port pins	FTW[31:24]	FTW[23:16]	FTW[15:8]	FTW[7:0]
0011	Full 32 bits of direct frequency tuning word control with different parallel port pin assignments	FTW[15:8]	FTW[7:0]	FTW[31:24]	FTW[23:16]
0100	Full 16 bits of direct phase offset control and full 12 bits of direct amplitude control	POW[15:8]	POW[7:0]	AMP[11:8]	AMP[7:0]
0101	Full 12 bits of direct amplitude control and full 16 bits of direct phase offset control	AMP[11:8]	AMP[7:0]	POW[15:8]	POW[7:0]
0110	24 bits of partial FTW control and 8 bits of partial amplitude control	FTW[31:24]	FTW[23:16]	FTW[15:8]	AMP[15:8]
0111	24 bits of partial FTW control and 8 bits of partial phase offset control	FTW[31:24]	FTW[23:16]	FTW[15:8]	POW[15:8]
1000	24 bits of partial FTW control and 8 bits of partial amplitude control	FTW[31:24]	FTW[23:16]	FTW[15:8]	AMP[7:0]
1001	24 bits of partial FTW control and 8 bits of partial phase offset control	FTW[31:24]	FTW[23:16]	FTW[15:8]	POW[7:0]
1010	24 bits of partial FTW control and 8 bits of partial amplitude control	FTW[23:16]	FTW[15:8]	FTW[7:0]	AMP[15:8]
1011	24 bits of partial FTW control and 8 bits of partial phase offset control	FTW[23:16]	FTW[15:8]	FTW[7:0]	POW[15:8]
1100	24 bits of partial FTW control and 8 bits of partial amplitude control	FTW[23:16]	FTW[15:8]	FTW[7:0]	AMP[7:0]
1101	24 bits of partial FTW control and 8 bits of partial phase offset control	FTW[23:16]	FTW[15:8]	FTW[7:0]	POW[7:0]
1110		Not used	Not used	Not used	Not used
1111		Not used	Not used	Not used	Not used

¹ Pin 31 to Pin 28.

² Pin 68 to Pin 72, Pin 75 to Pin 77.

³ Pin 78 to Pin 81, Pin 87, Pin 88, Pin 1, Pin 2.

⁴ Pin 3 to Pin 5, Pin 8 to Pin 12.

⁵ Pin 13 to Pin 15, Pin 18 to Pin 22.

PROGRAMMING AND FUNCTION PINS

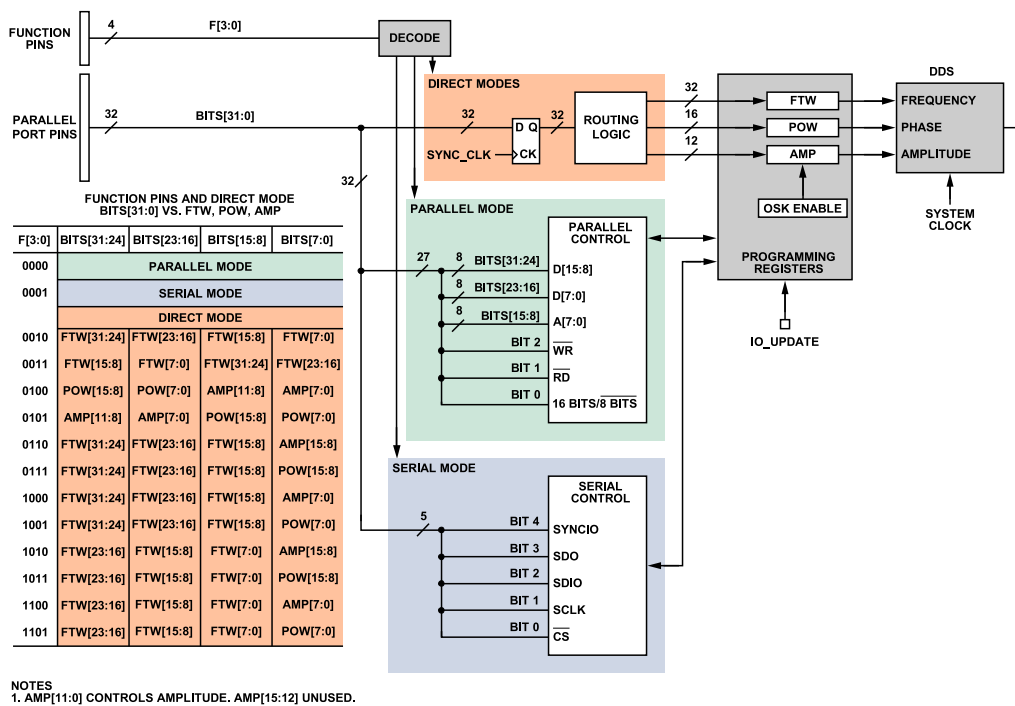

Figure 42. Parallel Port Block Diagram

The 32-pin parallel port of the AD9914 works in conjunction with an independent set of four function pins that control the functionality of the parallel port. The 32 pins of the parallel port constitute a 32-bit word designated by Bits[31:0] (31 indicating the most significant bit (MSB) and 0 indicating the least significant bit (LSB)), with the four function pins designated as F[3:0]. The relationship between the function pins, the 32-pin parallel port, the internal programming registers, and the DDS control parameters (frequency, phase, and amplitude) is illustrated in Figure 42. Note that the parallel port operates in three different modes as defined by the function pins.

The parallel mode is in effect when the logic levels applied to the function pins are F[3:0] = 0000. This allows the parallel port to function as a parallel interface providing access to all of the device programming registers. In parallel mode, the 32-pin port (Bits[31:0]) is subdivided into three groups with Bits[31:16] constituting 16 data bits, Bits[15:8] constituting eight address bits, and Bits[2:0] constituting three control bits. The address bits target a specific device register, whereas the data bits constitute the register content. The control bits establish read or write functionality as well as set the width of the data bus. That is, the user can select whether the data bus spans 16 bits (Bits[31:16]) or eight bits (Bits[23:16]). The parallel mode allows the user to write to the device registers at rates of up to 200 MBps using 16-bit data (or 100 MBps using 8-bit data).

The serial mode is in effect when the logic levels applied to the function pins are F[3:0] = 0001. This allows the parallel port to function as a serial interface providing access to all of the device programming registers. In this mode, only five pins of the 32-pin

parallel port are functional (Bits[4:0]). These pins provide chip select (\overline{CS}), serial clock (SCLK), and input/output synchronization (SYNCIO) functionality for the serial interface, as well as two serial data lines (SDO and SDIO). The serial mode supports data rates of up to 80 Mbps for write operations (read operations are constrained to <3 Mbps).

When the logic levels applied to the function pins are F[3:0] = 0010 to 1101 (note that 1110 and 1111 are unused), the parallel port functions as a high speed interface with direct access to the 32-bit frequency, 16-bit phase, and 12-bit amplitude parameters of the DDS core. The table in Figure 42 shows the segmentation of the 32-pin parallel port by identifying Bits[31:0] with the frequency (FTW[31:0]), phase (POW[15:0]), and amplitude (AMP[15:0]) parameters of the DDS. Note, however, that although AMP[15:0] indicate 16-bit resolution, the actual amplitude resolution is 12 bits. Therefore, only AMP[11:0] provide amplitude control (that is, AMP[15:12] are not used).

Furthermore, to make use of amplitude control, the user must be sure to program the OSK enable bit in the CFR1 register (0x00[8]) to Logic 1.

The combination of the F[3:0] pins and Bits[31:0] provides the AD9914 with unprecedented modulation capability by allowing the user direct control of the DDS parameters (frequency, phase, amplitude, or various combinations thereof). Furthermore, the parallel port operates at a sample rate equal to 1/24 of the system sample clock. This allows for updates of the DDS parameters at rates of up to 145 MSPS (assuming a 3.5 GHz system clock) allowing the

PROGRAMMING AND FUNCTION PINS

AD9914 to accommodate applications with wideband modulation requirements.

Be aware that the frequency, phase, and amplitude changes applied at the parallel port travel to the DDS core over different paths, experiencing different propagation times (latency). Therefore, modulating more than one DDS parameter necessitates setting the matched latency enable bit in the CFR2 register (0x01[15]) of the device, which equalizes the latency of each DDS parameter as it propagates from the parallel port to the DDS core. Note that high speed modulation requires a DAC reconstruction filter with sufficient bandwidth to accommodate the instantaneous time domain transitions.

Because direct access to the DDS parameters occurs via the FTW, POW, and AMP registers, the IO_UPDATE pin (see [Figure 42](#)) adds another layer of flexibility. That is, by default, 0x00[17] = 0. Therefore, writing data to the FTW, POW, or AMP registers does not make the data immediately available to the DDS core. Instead, the user must assert the IO_UPDATE pin to transfer the data from the FTW, POW, and AMP registers to the DDS core. Asserting the IO_UPDATE pin gives the user a level of control over the timing of when an FTW, POW, or AMP register change is applied to the DDS core. Note that assertion of IO_UPDATE or changing the state of the profile select pins (PS2 to PS0) is functionally equivalent. Furthermore, either action is gated by the rising edge of the internal SYNC_CLK signal.

However, when the logic levels applied to the function pins (F[3:0]) = 0010 to 1101 (that is, the high speed parallel data port is active), programming 0x00[17] = 1 activates streaming mode. In streaming mode, data at the D[31:0] pins is transferred to the FTW, POW, or AMP register and directly to the DDS core on each rising edge of the internal SYNC_CLK signal. Thus, streaming mode provides for wide band modulation by eliminating the need to assert IO_UPDATE.

As an example to demonstrate the flexibility of the parallel data port, suppose an application requires frequency and amplitude modulation with full 32-bit frequency resolution and full 12-bit amplitude resolution. Note that none of the F[3:0] pin combinations supports such modulation capability directly. To circumvent this problem, program 0x00[17] = 0 (that is, disable streaming mode). This setting allows the use of two direct mode cycles of the 32-pin parallel port, each with a different function pin setting, without affecting the DDS core until assertion of the IO_UPDATE pin. That is, the first direct mode cycle constitutes setting the function pins to F[3:0] = 0010, which routes all 32 bits to the FTW register (frequency). The second direct mode cycle constitutes setting the function pins to F[3:0] = 0100, which provides full 12-bit access to the AMP register (amplitude). Be aware, however, that F[3:0] = 0100 also includes the POW register (phase). Therefore, be sure keep the phase bits unchanged from their previous value. Next, toggle the IO_UPDATE pin, which synchronously (on the rising edge of the internal SYNC_CLK signal) transfers the new frequency and phase values from the FTW and POW registers to the DDS core. This

mode of operation reduces the overall modulation rate by a factor of three because it requires two direct mode cycles (a minimum of two SYNC_CLK periods) followed by an IO_UPDATE assertion. However, this mode still allows modulation sample rates as high as ~49 MSPS.

SERIAL PROGRAMMING

To enable SPI operations, set Pin 28 (F0) to logic high and Pin 29 to Pin 31 (F1 to F3) to logic low. To program the AD9914 with a parallel interface, see the [Parallel Programming \(8-/16-Bit\)](#) section.

CONTROL INTERFACE—SERIAL INPUT/OUTPUT

The AD9914 serial port is a flexible, synchronous serial communications port allowing easy interface to many industry-standard microcontrollers and microprocessors. The serial input/output is compatible with most synchronous transfer formats.

The interface allows read/write access to all registers that configure the AD9914. MSB-first or LSB-first transfer formats are supported. In addition, the serial interface port can be configured as a single pin input/output (SDIO) allowing a 2-wire interface, or it can be configured as two unidirectional pins for input/output (SDIO and SDO), enabling a 3-wire interface. Two optional pins (I/O_SYNC and \overline{CS}) enable greater flexibility for designing systems with the AD9914.

Table 12. Serial Input/Output Pin Description

Pin No.	Mnemonic	Serial Input/Output Description
18	D4/SYNCIO	SYNCIO
19	D3/SDO	SDO
20	D2/SDIO/ \overline{WR}	SDIO
21	D1/SCLK/ \overline{RD}	SCLK
22	D0/ \overline{CS} /PWD	\overline{CS} —chip select

GENERAL SERIAL INPUT/OUTPUT OPERATION

There are two phases to a serial communications cycle. The first is the instruction phase to write the instruction byte into the AD9914. The instruction byte contains the address of the register to be accessed and defines whether the upcoming data transfer is a write or read operation.

For a write cycle, Phase 2 represents the data transfer between the serial port controller to the serial port buffer. The number of bytes transferred is a function of the register being accessed. For example, when accessing Control Function Register 2 (Address 0x01), Phase 2 requires that four bytes be transferred. Each bit of data is registered on each corresponding rising edge of SCLK. The serial port controller expects that all bytes of the register be accessed; otherwise, the serial port controller is put out of sequence for the next communication cycle. However, one way to write fewer bytes than required is to use the SYNCIO pin feature. The SYNCIO pin function can abort an input/output operation and reset the pointer of the serial port controller. After a SYNCIO, the next byte is the instruction byte. Note that every completed byte written prior to a SYNCIO is preserved in the serial port buffer. Partial bytes written are not preserved. At the completion of any communication cycle, the AD9914 serial port controller expects the next eight rising SCLK edges to be the instruction byte for the next communication cycle.

After a write cycle, the programmed data resides in the serial port buffer and is inactive. I/O_UPDATE transfers data from the serial port buffer to active registers. The input/output update can be sent either after each communication cycle or when all serial operations are complete. In addition, a change in profile pins can initiate an input/output update.

For a read cycle, Phase 2 is the same as the write cycle with the following differences: data is read from the active registers, not the serial port buffer, and data is driven out on the falling edge of SCLK.

Note that, to read back any profile register (0x0B to 0x1A), the three external profile pins must be used. For example, if the profile register is Profile 5 (0x15), the PS[0:2] pins must equal 101. This is not required to write to the profile registers.

INSTRUCTION BYTE

The instruction byte contains the following information as shown in the instruction byte information bit map.

Instruction Byte Information Bit Map

MSB							LSB
17	16	15	14	13	12	11	10
R/ \overline{W}	X	A5	A4	A3	A2	A1	A0

R/ \overline{W} —Bit 7 of the instruction byte determines whether a read or write data transfer occurs after the instruction byte write. Logic 1 indicates a read operation. Logic 0 indicates a write operation.

X—Bit 6 of the instruction byte is don't care.

A5, A4, A3, A2, A1, A0—Bit 5, Bit 4, Bit 3, Bit 2, Bit 1, and Bit 0 of the instruction byte determine which register is accessed during the data transfer portion of the communications cycle.

SERIAL INPUT/OUTPUT PORT PIN DESCRIPTIONS

SCLK—Serial Clock

The serial clock pin synchronizes data to and from the AD9914 and to run the internal state machines.

\overline{CS} —Chip Select Bar

\overline{CS} is an active low input that allows more than one device on the same serial communications line. The SDO and SDIO pins go to a high impedance state when this input is high. If driven high during any communications cycle, that cycle is suspended until \overline{CS} is reactivated low. Chip select (\overline{CS}) can be tied low in systems that maintain control of SCLK.

SDIO—Serial Data Input/Output

Data is always written into the AD9914 on this pin. However, this pin can be used as a bidirectional data line. Bit 1 of CFR1 (0x00)

SERIAL PROGRAMMING

controls the configuration of this pin. The default is Logic 0, which configures the SDIO pin as bidirectional.

SDO—Serial Data Out

Data is read from this pin for protocols that use separate lines for transmitting and receiving data. When the AD9914 operates in single bidirectional input/output mode, this pin does not output data and is set to a high impedance state.

SYNCIO—Input/Output Reset

SYNCIO synchronizes the input/output port state machines without affecting the contents of the addressable registers. An active high input on the SYNCIO pin causes the current communication cycle to abort. After SYNCIO returns low (Logic 0), another communication cycle can begin, starting with the instruction byte write.

I/O_UPDATE—Input/Output Update

The input/output update initiates the transfer of written data from the serial or parallel input/output port buffer to active registers. I/O_UPDATE is active on the rising edge, and the pulse width must be greater than one SYNC_CLK period.

SERIAL INPUT/OUTPUT TIMING DIAGRAMS

Figure 43 through Figure 46 provide basic examples of the timing relationships between the various control signals of the serial input/output port. Most of the bits in the register map are not transferred to the internal destinations until assertion of an input/output update, which is not included in the timing diagrams that follow.

Note that the SCLK stall condition between the instruction byte cycle and data transfer cycle in Figure 43 to Figure 46 is not required.

MSB/LSB TRANSFERS

The AD9914 serial port can support both most significant bit (MSB) first or least significant bit (LSB) first data formats. This functionality is controlled by Bit 0 in CFR1 (0x00). The default format is MSB first. If LSB first is active, all data, including the instruction byte, must follow LSB-first convention. Note that the highest number found in the bit range column for each register is the MSB, and the lowest number is the LSB for that register.

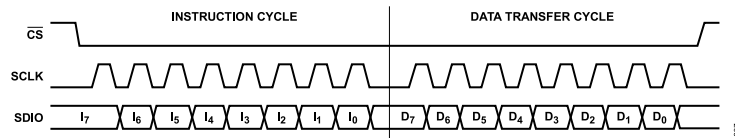

Figure 43. Serial Port Write Timing, Clock Stall Low

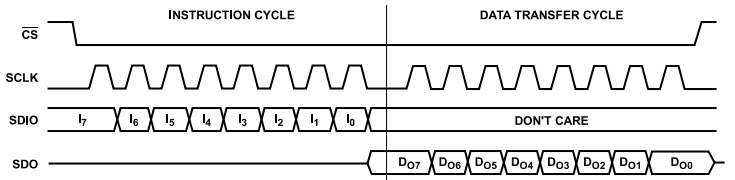

Figure 44. 3-Wire Serial Port Read Timing, Clock Stall Low

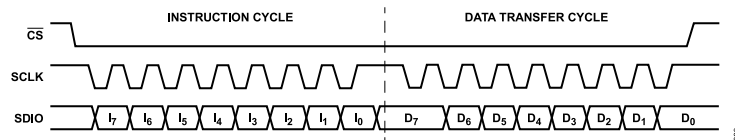

Figure 45. Serial Port Write Timing, Clock Stall High

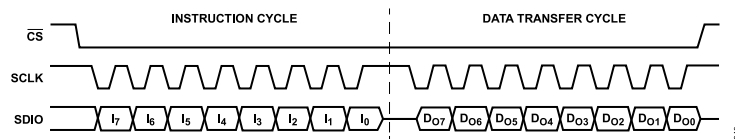

Figure 46. 2-Wire Serial Port Read Timing, Clock Stall High

PARALLEL PROGRAMMING (8-/16-BIT)

The state of the external function pins (F0 to F3) determine the type of interface used by the AD9914. Pin 28 to Pin 31 are dedicated function pins. To enable the parallel mode interface set Pin 28 to Pin 31 to logic low.

Parallel programming consists of eight address lines and either eight or 16 bidirectional data lines for read/write operations. The logic state on Pin 22 determines the width of the data bus used. A logic low on Pin 22 sets the data width to eight bits, and logic high sets the data width to 16 bits. In addition, parallel mode has dedicated write/read control inputs. If 16-bit mode is used, the upper byte, Bits[15:8], goes to the addressed register and the lower byte, Bits[7:0], goes to the adjacent lower address.

Parallel input/output operation allows write access to each byte of any register in a single input/output operation. Readback capability for each register is included to ease designing with the AD9914.

Table 13. Parallel Port Read Timing (See Figure 47)

Parameter	Value	Unit	Test Conditions/Comments
t_{ADV}	92	ns max	Address to data valid time

Table 13. Parallel Port Read Timing (See Figure 47)

Parameter	Value	Unit	Test Conditions/Comments
t_{AHD}	0	ns min	Address hold time to \overline{RD} signal inactive
t_{RDLOV}	69	ns max	\overline{RD} low to output valid
t_{RDHOZ}	50	ns max	\overline{RD} high to data three-state
t_{RDLOW}	69	ns max	\overline{RD} signal minimum low time
t_{RDHIGH}	50	ns max	\overline{RD} signal minimum high time

Table 14. Parallel Port Write Timing (See Figure 48)

Parameter	Value	Unit	Test Conditions/Comments
t_{ASU}	1	ns	Address setup time to \overline{WR} signal active
t_{DSU}	3.8	ns	Data setup time to \overline{WR} signal active
t_{AHD}	0	ns	Address hold time to \overline{WR} signal inactive
t_{DHD}	0	ns	Data hold time to \overline{WR} signal inactive
t_{WRLow}	2.1	ns	\overline{WR} signal minimum low time
t_{WRHIGH}	3.8	ns	\overline{WR} signal minimum high time
t_{WR}	10.5	ns	Minimum write time

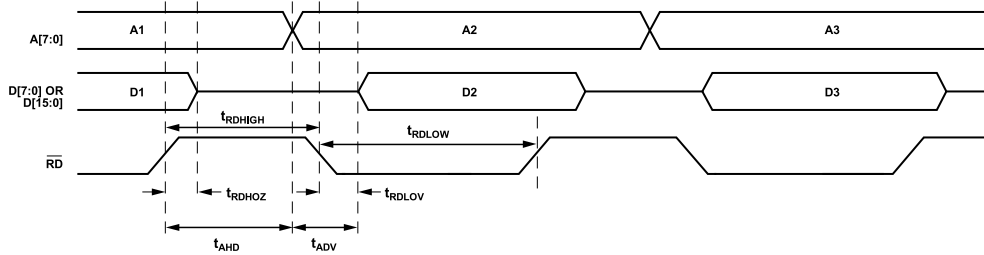

Figure 47. Parallel Port Read Timing Diagram

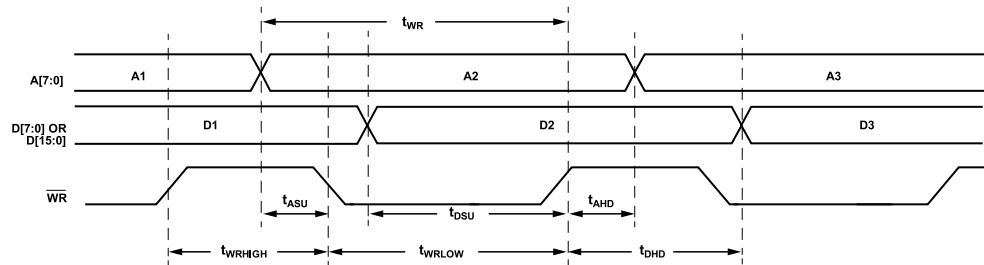

Figure 48. Parallel Port Write Timing Diagram

REGISTER MAP AND BIT DESCRIPTIONS

Table 15. Register Map

Register Name (Serial Address)	Bit Range (Parallel Address)	Bit 7 (MSB)	Bit 6	Bit 5	Bit 4	Bit 3	Bit 2	Bit 1	Bit 0 (LSB)	Default Value (Hex) ¹	
CFR1—Control Function Register 1 (0x00)	[7:0](0x00)	Digital power-down	DAC power-down	REF CLK input power-down	Open	External power-down control	Open	SDIO input only	LSB first mode	0x08	
	[15:8] (0x01)	Load LRR on input/output update	Autoclear digital ramp accumulator	Autoclear phase accumulator	Clear digital ramp accumulator	Clear phase accumulator	Open	External OSK enable	OSK enable	0x00	
	[23:16] (0x02)	Open						Parallel port streaming enable	Enable sine output	0x01	
	[31:24] (0x03)	Open							VCO cal enable	0x00	
CFR2—Control Function Register 2 (0x01)	[7:0](0x04)	Open									0x00
	[15:8] (0x05)	Matched latency enable	Frequency jump enable	DRG over output enable	Open	SYNC_CLK enable	SYNC_CLK invert	Reserved	Open	0x09	
	[23:16] (0x06)	Profile mode enable	Parallel data port enable	Digital ramp destination		Digital ramp enable	Digital ramp no-dwell high	Digital ramp no-dwell low	Programmable modulus enable	0x00	
	[31:24] (0x07)	Open									0x00
CFR3—Control Function Register 3 (0x02)	[7:0](0x08)	Open	Manual I _{CP} selection	I _{CP} [2:0]			Lock detect enable	Minimum LDW[1:0]			0x1C
	[15:8] (0x09)	Feedback Divider N[7:0]									0x19
	[23:16] (0x0A)	Open	PLL input divider reset	PLL input divide value[1:0]	PLL input doubler select	PLL enable	PLL input divider select	PLL edge select	0x00		
	[31:24] (0x0B)	Open									0x00
CFR4—Control Function Register 4 (0x03)	[7:0](0x0C)	Requires register default value settings (0x20)									0x20
	[15:8] (0x0D)	Requires register default value settings (0x21)									0x21
	[23:16] (0x0E)	Requires register default value settings (0x05)									0x05
	[31:24] (0x0F)	Open					Auxiliary divider power-down	DAC CAL clock power-down	DAC CAL enable ²	0x00	
Digital Ramp Lower Limit Register (0x04)	[7:0] (0x10)	Digital ramp lower limit[7:0]									0x00
	[15:8] (0x11)	Digital ramp lower limit[15:8]									0x00
	[23:16] (0x12)	Digital ramp lower limit[23:16]									0x00
	[31:24] (0x13)	Digital ramp lower limit[31:24]									0x00
Digital Ramp Upper Limit Register (0x05)	[7:0] (0x14)	Digital ramp upper limit[7:0]									0x00
	[15:8] (0x15)	Digital ramp upper limit[15:8]									0x00
	[23:16] (0x16)	Digital ramp upper limit[23:16]									0x00
	[31:24] (0x17)	Digital ramp upper limit[31:24]									0x00

REGISTER MAP AND BIT DESCRIPTIONS

Table 15. Register Map

Register Name (Serial Address)	Bit Range (Parallel Address)	Bit 7 (MSB)	Bit 6	Bit 5	Bit 4	Bit 3	Bit 2	Bit 1	Bit 0 (LSB)	Default Value (Hex) ¹
Rising Digital Ramp Step Size Register (0x06)	[7:0] (0x18)				Rising digital ramp increment step size[7:0]					N/A
	[15:8] (0x19)				Rising digital ramp increment step size[15:8]					N/A
	[23:16] (0x1A)				Rising digital ramp increment step size[23:16]					N/A
	[31:24] (0x1B)				Rising digital ramp increment step size[31:24]					N/A
Falling Digital Ramp Step Size Register (0x07)	[7:0] (0x1C)				Falling digital ramp decrement step size[7:0]					N/A
	[15:8] (0x1D)				Falling digital ramp decrement step size[15:8]					N/A
	[23:16] (0x1E)				Falling digital ramp decrement step size[23:16]					N/A
	[31:24] (0x1F)				Falling digital ramp decrement step size[31:24]					N/A
Digital Ramp Rate Register (0x08)	[7:0] (0x20)				Digital ramp positive slope rate[7:0]					N/A
	[15:8] (0x21)				Digital ramp positive slope rate[15:8]					N/A
	[23:16] (0x22)				Digital ramp negative slope rate[7:0]					N/A
	[31:24] (0x23)				Digital ramp negative slope rate[15:8]					N/A
Lower Frequency Jump Register (0x09)	[7:0] (0x24)				Lower frequency jump point[7:0]					0x00
	[15:8] (0x25)				Lower frequency jump point[15:8]					0x00
	[23:16] (0x26)				Lower frequency jump point[23:16]					0x00
	[31:24] (0x27)				Lower frequency jump point[31:24]					0x00
Upper Frequency Jump Register (0x0A)	[7:0] (0x28)				Upper frequency jump point[7:0]					0x00
	[15:8] (0x29)				Upper frequency jump point[15:8]					0x00
	[23:16] (0x2A)				Upper frequency jump point[23:16]					0x00
	[31:24] (0x2B)				Upper frequency jump point[31:24]					0x00
Profile 0 (P0) Frequency Tuning Word 0 Register (0x0B)	[7:0] (0x2C)				Frequency Tuning Word 0[7:0]					0x00
	[15:8] (0x2D)				Frequency Tuning Word 0[15:8]					0x00
	[23:16] (0x2E)				Frequency Tuning Word 0[23:16]					0x00
	[31:24] (0x2F)				Frequency Tuning Word 0[31:24]					0x00
Profile 0 (P0) Phase/Amplitude Register (0x0C)	[7:0] (0x30)				Phase Offset Word 0[7:0]					0x00
	[15:8] (0x31)				Phase Offset Word 0[15:8]					0x00
	[23:16] (0x32)				Amplitude Scale Factor 0[7:0]					0x00
	[31:24] (0x33)			Open	Amplitude Scale Factor 0[11:8]					0x00

REGISTER MAP AND BIT DESCRIPTIONS

Table 15. Register Map

Register Name (Serial Address)	Bit Range (Parallel Address)	Bit 7 (MSB)	Bit 6	Bit 5	Bit 4	Bit 3	Bit 2	Bit 1	Bit 0 (LSB)	Default Value (Hex) ¹
Profile 1 (P1) Frequency Tuning Word 1 Register (0x0D)	[7:0] (0x34)				Frequency Tuning Word 1[7:0]					N/A
	[15:8] (0x35)				Frequency Tuning Word 1[15:8]					N/A
	[23:16] (0x36)				Frequency Tuning Word 1[23:16]					N/A
	[31:24] (0x37)				Frequency Tuning Word 1[31:24]					N/A
Profile 1 (P1) Phase/Amplitude Register (0x0E)	[7:0] (0x38)				Phase Offset Word 1[7:0]					N/A
	[15:8] (0x39)				Phase Offset Word 1[15:8]					N/A
	[23:16] (0x3A)				Amplitude Scale Factor 1[7:0]					N/A
	[31:24] (0x3B)			Open	Amplitude Scale Factor 1[11:8]					N/A
Profile 2 (P2) Frequency Tuning Word 2 Register (0x0F)	[7:0] (0x3C)				Frequency Tuning Word 2[7:0]					N/A
	[15:8] (0x3D)				Frequency Tuning Word 2[15:8]					N/A
	[23:16] (0x3E)				Frequency Tuning Word 2[23:16]					N/A
	[31:24] (0x3F)				Frequency Tuning Word 2[31:24]					N/A
Profile 2 (P2) Phase/Amplitude Register (0x10)	[7:0] (0x40)				Phase Offset Word 2[7:0]					N/A
	[15:8] (0x41)				Phase Offset Word 2[15:8]					N/A
	[23:16] (0x42)				Amplitude Scale Factor 2[7:0]					N/A
	[31:24] (0x43)			Open	Amplitude Scale Factor 2[11:8]					N/A
Profile 3 (P3) Frequency Tuning Word 3 Register (0x11)	[7:0] (0x44)				Frequency Tuning Word 3[7:0]					N/A
	[15:8] (0x45)				Frequency Tuning Word 3[15:8]					N/A
	[23:16] (0x46)				Frequency Tuning Word 3[23:16]					N/A
	[31:24] (0x47)				Frequency Tuning Word 3[31:24]					N/A
Profile 3 (P3) Phase/Amplitude Register (0x12)	[7:0] (0x48)				Phase Offset Word 3[7:0]					N/A
	[15:8] (0x49)				Phase Offset Word 3[15:8]					N/A
	[23:16] (0x4A)				Amplitude Scale Factor 3[7:0]					N/A
	[31:24] (0x4B)			Open	Amplitude Scale Factor 3[11:8]					N/A
Profile 4 (P4) Frequency Tuning Word 4 Register (0x13)	[7:0] (0x4C)				Frequency Tuning Word 4[7:0]					N/A
	[15:8] (0x4D)				Frequency Tuning Word 4[15:8]					N/A
	[23:16] (0x4E)				Frequency Tuning Word 4[23:16]					N/A
	[31:24] (0x4F)				Frequency Tuning Word 4[31:24]					N/A

REGISTER MAP AND BIT DESCRIPTIONS

Table 15. Register Map

Register Name (Serial Address)	Bit Range (Parallel Address)	Bit 7 (MSB)	Bit 6	Bit 5	Bit 4	Bit 3	Bit 2	Bit 1	Bit 0 (LSB)	Default Value (Hex) ¹
Profile 4 (P4) Phase/Amplitude Register (0x14)	[7:0] (0x50)				Phase Offset Word 4[7:0]					N/A
	[15:8] (0x51)				Phase Offset Word 4[15:8]					N/A
	[23:16] (0x52)				Amplitude Scale Factor 4[7:0]					N/A
	[31:24] (0x53)			Open			Amplitude Scale Factor 4[11:8]			N/A
Profile 5 (P5) Frequency Tuning Word 5 Register (0x15)	[7:0] (0x54)				Frequency Tuning Word 5[7:0]					N/A
	[15:8] (0x55)				Frequency Tuning Word 5[15:8]					N/A
	[23:16] (0x56)				Frequency Tuning Word 5[23:16]					N/A
	[31:24] (0x57)				Frequency Tuning Word 5[31:24]					N/A
Profile 5 (P5) Phase/Amplitude Register (0x16)	[7:0] (0x58)				Phase Offset Word 5[7:0]					N/A
	[15:8] (0x59)				Phase Offset Word 5[15:8]					N/A
	[23:16] (0x5A)				Amplitude Scale Factor 5[7:0]					N/A
	[31:24] (0x5B)			Open			Amplitude Scale Factor 5[11:8]			N/A
Profile 6 (P6) Frequency Tuning Word 6 Register (0x17)	[7:0] (0x5C)				Frequency Tuning Word 6[7:0]					N/A
	[15:8] (0x5D)				Frequency Tuning Word 6[15:8]					N/A
	[23:16] (0x5E)				Frequency Tuning Word 6[23:16]					N/A
	[31:24] (0x5F)				Frequency Tuning Word 6[31:24]					N/A
Profile 6 (P6) Phase/Amplitude Register (0x18)	[7:0] (0x60)				Phase Offset Word 6[7:0]					N/A
	[15:8] (0x61)				Phase Offset Word 6[15:8]					N/A
	[23:16] (0x62)				Amplitude Scale Factor 6[7:0]					N/A
	[31:24] (0x63)			Open			Amplitude Scale Factor 6[11:8]			n/a
Profile 7 (P7) Frequency Tuning Word 7 Register (0x19)	[7:0] (0x64)				Frequency Tuning Word 7[7:0]					N/A
	[15:8] (0x65)				Frequency Tuning Word 7[15:8]					N/A
	[23:16] (0x66)				Frequency Tuning Word 7[23:16]					N/A
	[31:24] (0x67)				Frequency Tuning Word 7[31:24]					N/A
Profile 7 (P7) Phase/Amplitude Register (0x1A)	[7:0] (0x68)				Phase Offset Word 7[7:0]					N/A
	[15:8] (0x69)				Phase Offset Word 7[15:8]					N/A
	[23:16] (0x6A)				Amplitude Scale Factor 7[7:0]					N/A
	[31:24] (0x6B)			Open			Amplitude Scale Factor 7[11:8]			N/A

REGISTER MAP AND BIT DESCRIPTIONS

Table 15. Register Map

Register Name (Serial Address)	Bit Range (Parallel Address)	Bit 7 (MSB)	Bit 6	Bit 5	Bit 4	Bit 3	Bit 2	Bit 1	Bit 0 (LSB)	Default Value (Hex) ¹
USR0 (0x1B)	[7:0] (0x6C)						Requires register default value settings (0x00)			0x00
	[15:8] (0x6D)						Requires register default value settings (0x08)			0x08
	[23:16] (0x6E)						Requires register default value settings (0x00)			0x00
	[31:24] (0x6F)					Open			PLL lock	Read only

¹ A master reset is required after power up. The master reset returns the internal registers to the default values.

² The DAC CAL enable bit must be manually set and then cleared after each power-up and every time REF CLK or the internal system clock is changed. This initiates an internal calibration routine to optimize the setup and hold times for internal DAC timing. Failure to calibrate degrades ac performance or makes the device nonfunctional.

REGISTER BIT DESCRIPTIONS

The serial input/output port registers span an address range of 0 to 27 (0x00 to 0x1B in hexadecimal notation). This represents a total of 28 individual serial registers. If programming in parallel mode, the number of parallel registers increases to 112 individual parallel registers. Additionally, the registers are assigned names according to the functionality. In some cases, a register is given a mnemonic descriptor. For example, the register at Serial Address 0x00 is named Control Function Register 1 and is assigned the mnemonic CFR1.

This section provides a detailed description of each bit in the AD9914 register map. For cases in which a group of bits serves a specific function, the entire group is considered a binary word and is described in aggregate.

This section is organized in sequential order of the serial addresses of the registers. Each subheading includes the register name and optional register mnemonic (in parentheses). Also given is the serial address in hexadecimal format and the number of bytes assigned to the register.

Following each subheading is a table containing the individual bit descriptions for that particular register. The location of the bit(s) in the register is indicated by a single number or a pair of numbers separated by a colon; that is, a pair of numbers (A:B) indicates a range of bits from the most significant (A) to the least significant (B). For example, [5:2] implies Bit Position 5 to Bit Position 2, inclusive, with Bit 0 identifying the LSB of the register.

Unless otherwise stated, programmed bits are not transferred to the internal destinations until the assertion of the I/O_UPDATE pin or a profile pin change.

REGISTER MAP AND BIT DESCRIPTIONS

Control Function Register 1 (CFR1)—Address 0x00

Table 16. Bit Description for CFR1

Bits	Mnemonic	Description
[31:25]	Open	
24	VCO cal enable	1 = initializes the auto internal PLL calibration. The calibration is required if the PLL is to provide the internal system clock. Must first be reset to Logic 0 before another calibration can be issued.
[23:18]	Open	Open.
17	Parallel port streaming enable	0 = the 32 bit parallel port needs an input/output update to activate or register any FTW, POW, or AMP data presented to the 32-bit parallel port. 1 = the parallel port continuously samples data on the 32 input pins using SYNC_CLK and multiplexes the value of FTW/POW/AMP accordingly, per the configuration of the F0 to F3 pins, without the need of an input/output update. Data must meet the setup and hold times of the SYNC_CLK rising edge. If the function pins are used dynamically to alter data between parameters, they must also meet the timing of the SYNC_CLK edge.
16	Enable sine output	0 = cosine output of the DDS is selected. 1 = sine output of the DDS is selected (default).
15	Load LRR on input/output update	Ineffective unless CFR2[19] = 1. 0 = normal operation of the digital ramp timer (default). 1 = interrupts the digital ramp timer operation to load a new linear ramp rate (LRR) value any time I/O_UPDATE is asserted or a PS[2:0] change occurs.
14	Autoclear digital ramp accumulator	0 = normal operation of the DRG accumulator (default). 1 = the digital ramp accumulator is reset for one cycle of the DDS clock (SYNC_CLK), after which the accumulator automatically resumes normal operation. As long as this bit remains set, the ramp accumulator is momentarily reset each time an input/output update is asserted or a PS[2:0] change occurs. This bit is synchronized with either an input/output update or a PS[2:0] change and the next rising edge of SYNC_CLK.
13	Autoclear phase accumulator	0 = normal operation of the DDS phase accumulator (default). 1 = synchronously resets the DDS phase accumulator anytime I/O_UPDATE is asserted or a profile change occurs.
12	Clear digital ramp accumulator	0 = normal operation of the digital ramp generator (default). 1 = asynchronous, static reset of the DRG accumulator. The ramp accumulator remains reset as long as this bit remains set. This bit is synchronized with either an input/output update or a PS[2:0] change and the next rising edge of SYNC_CLK.
11	Clear phase accumulator	0 = normal operation of the DDS phase accumulator (default). 1 = asynchronous, static reset of the DDS phase accumulator as long as this bit is set. This bit is synchronized with either an input/output update or a PS[2:0] change and the next rising edge of SYNC_CLK.
10	Open	Open.
9	External OSK enable	0 = manual OSK enabled (default). 1 = automatic OSK enabled. Ineffective unless CFR1[8] = 1.
8	OSK enable	0 = OSK disabled (default). 1 = OSK enabled. This bit must be set to affect any digital amplitude change using the DRG, a profile, direct mode via the 32-bit parallel port, or OSK pin.
7	Digital power-down	This bit is effective without the need for an input/output update. 0 = clock signals to the digital core are active (default). 1 = clock signals to the digital core are disabled.
6	DAC power-down	0 = DAC clock signals and bias circuits are active (default). 1 = DAC clock signals and bias circuits are disabled.
5	REFCLK input power-down	This bit is effective without the need for an input/output update. 0 = REFCLK input circuits and PLL are active (default). 1 = REFCLK input circuits and PLL are disabled.
4	Open	Open.
3	External power-down control	0 = assertion of the EXT_PWR_DWN pin affects fast recovery power-down.

REGISTER MAP AND BIT DESCRIPTIONS

Table 16. Bit Description for CFR1

Bits	Mnemonic	Description
		1 = assertion of the EXT_PWR_DWN pin affects power-down.
2	Open	Open.
1	SDIO input only	0 = configures the SDIO pin for bidirectional operation; 2-wire serial programming mode (default). 1 = configures the serial data input/output pin (SDIO) as an input only pin; 3-wire serial programming mode.
0	LSB first mode	0 = configures the serial input/output port for MSB-first format (default). 1 = configures the serial input/output port for LSB-first format.

Control Function Register 2 (CFR2)—Address 0x01

Table 17. Bit Descriptions for CFR2

Bit(s)	Mnemonic	Description
[31:24]	Open	Open.
23	Profile mode enable	0 = disables profile mode functionality (default). 1 = enables profile mode functionality. Profile pins select the desired profile.
22	Parallel data port enable	See the Parallel Data Port Modulation Mode section for more details. 0 = disables parallel data port modulation functionality (default). 1 = enables parallel data port modulation functionality.
[21:20]	Digital ramp destination	See Table 9 for details. Default is 00. See the Digital Ramp Generator (DRG) section for more details.
19	Digital ramp enable	0 = disables digital ramp generator functionality (default). 1 = enables digital ramp generator functionality.
18	Digital ramp no-dwell high	See the Digital Ramp Generator (DRG) section for details. 0 = disables no-dwell high functionality (default). 1 = enables no-dwell high functionality.
17	Digital ramp no-dwell low	See the Digital Ramp Generator (DRG) section for details. 0 = disables no-dwell low functionality (default). 1 = enables no-dwell low functionality.
16	Programmable modulus enable	0 = disables programmable modulus. 1 = enables programmable modulus.
15	Matched latency enable	0 = simultaneous application of amplitude, phase, and frequency changes to the DDS arrive at the output at different times based on their individual path latency listed in Table 2 under data latency (pipe line delay)(default). 1 = simultaneous application of amplitude, phase, and frequency changes to the DDS arrive at the output simultaneously.
14	Frequency jump enable	0 = disables frequency jump mode (default). 1 = enables frequency jump mode. Must have the digital generator DRG enabled for this feature.
13	DRG over output enable	0 = disables the DROVER output. 1 = enables the DROVER output.
12	Open	Open.
11	SYNC_CLK enable	0 = the SYNC_CLK pin is disabled and forced to a static Logic 0 state; the internal clock signal continues to operate and provide timing. 1 = the internal SYNC_CLK signal appears at the SYNC_CLK pin (default).
10	SYNC_CLK invert	0 = normal SYNC_CLK pin polarity (default). 1 = inverted SYNC_CLK pin polarity.
9	Reserved	Keep logic 0.
[8:0]	Open	Open.

REGISTER MAP AND BIT DESCRIPTIONS

Control Function Register 3 (CFR3)—Address 0x02

Table 18. Bit Descriptions for CFR3

Bit(s)	Mnemonic	Description
[31:23]	Open	Open.
22	PLL input divider reset	0 = disables the PLL input divider reset function. 1 = resets the PLL input divider.
[21:20]	PLL input divide value	Divides the input REF CLK signal to the PLL by one of three values (2, 4, 8). Bit 17 must be set to Logic 1 to use the PLL input divider. 00 = disable divider. 01 = divide by 2. 10 = divide by 4. 11 = divide by 8.
19	PLL input doubler select	0 = selects the feedthrough path. 1 = selects the 2× path. This bit is only meaningful when CFR3[18] = 1 and CFR3[17] = 0.
18	PLL enable	0 = disables the internal PLL. 1 = enables the internal PLL for generating the system clock (the PLL must be calibrated via CFR1[24]).
17	PLL input divider select	0 = Selects the feed through and 2× multiplier paths. 1 = selects the PLL input divider path. This bit is only meaningful when CFR3[18] = 1.
16	PLL edge select	0 = select rising edge. 1 = select falling edge. This bit is only meaningful when CFR3[18] = 1, CFR3[17] = 0 and CFR3[19] = 0. The PLL locks to the selected edge of REF_CLK.
[15:8]	Feedback divider N	The N divider value in Bits[15:8] is one part of the total PLL multiplication available. The second part is the fixed divide by two element in the feedback path. Therefore, the total PLL multiplication value is 2N. The valid N divider range is 10× to 255×. The default N value for Bits[15:8] = 25, which sets the total default PLL multiplication to 50× or 2N.
7	Open	Open.
6	Manual I _{CP} selection	0 = the internal charge pump current is chosen automatically during the VCO calibration routine (default). 1 = the internal charge pump is set manually per Table 7.
[5:3]	I _{CP}	Manual charge pump current selection. See Table 7.
2	Lock detect enable	0 = disables PLL lock detection. 1 = enables PLL lock detection.
[1:0]	Minimum LDW	Selects the number of REF CLK cycles that the phase error (at the PFD inputs) must remain within before a PLL lock condition can be read back via Bit 24 in Register 0x00. 00 = 128 REF CLK cycles. 01 = 256 REF CLK cycles. 10 = 512 REF CLK cycles. 11 = 1024 REF CLK cycles.

Control Function Register 4 (CFR4)—Address 0x03

Table 19. Bit Descriptions for DAC

Bit(s)	Mnemonic	Description
[31:27]	Open	Open.
26	Auxiliary divider power-down	0 = enables the SYNC OUT circuitry. 1 = disables the SYNC OUT circuitry.
25	DAC CAL clock power-down	0 = enables the DAC CAL clock if Bit 26 in Register 0x03 is Logic 0. 1 = disables the DAC CAL clock.
24	DAC CAL enable	1 = initiates an auto DAC calibration. The DAC CAL calibration is required at power-up and any time the internal system clock is changed.
[23:0]	(See description)	These bits must always be programmed with the default values listed in the default column in Table 15.

REGISTER MAP AND BIT DESCRIPTIONS

Digital Ramp Lower Limit Register—Address 0x04

This register is effective only if the digital ramp enable bit in the CFR2 register (0x01[19]) = 1. See the [Digital Ramp Generator \(DRG\)](#) section for details.

Table 20. Bit Descriptions for Digital Ramp Lower Limit Register

Bit(s)	Mnemonic	Description
[31:0]	Digital ramp lower limit	32-bit digital ramp lower limit value.

Digital Ramp Upper Limit Register—Address 0x05

This register is effective only if the digital ramp enable bit in the CFR2 register (0x01[19]) = 1. See the [Digital Ramp Generator \(DRG\)](#) section for details.

Table 21. Bit Descriptions for Digital Ramp Limit Register

Bit(s)	Mnemonic	Description
[31:0]	Digital ramp upper limit	32-bit digital ramp upper limit value.

Rising Digital Ramp Step Size Register—Address 0x06

This register is effective only if the digital ramp enable bit in the CFR2 register (0x01[19]) = 1. See the [Digital Ramp Generator \(DRG\)](#) section for details.

Table 22. Bit Descriptions for Rising Digital Ramp Step Size Register

Bit(s)	Mnemonic	Description
[31:0]	Rising digital ramp increment step size	32-bit digital ramp increment step size value.

Falling Digital Ramp Step Size Register—Address 0x07

This register is effective only if the digital ramp enable bit in the CFR2 register (0x01[19]) = 1. See the [Digital Ramp Generator \(DRG\)](#) section for details.

Table 23. Bit Descriptions for Falling Digital Ramp Step Size Register

Bit(s)	Mnemonic	Description
[31:0]	Falling digital ramp decrement step size	32-bit digital ramp decrement step size value.

Digital Ramp Rate Register—Address 0x08

This register is effective only if the digital ramp enable bit in the CFR2 register (0x01[19]) = 1. See the [Digital Ramp Generator \(DRG\)](#) section for details.

Table 24. Bit Descriptions for Digital Ramp Rate Register

Bit(s)	Mnemonic	Description
[31:16]	Digital ramp negative slope rate	16-bit digital ramp negative slope value that defines the time interval between decrement values.
[15:0]	Digital ramp positive slope rate	16-bit digital ramp positive slope value that defines the time interval between increment values.

Lower Frequency Jump Register—Address 0x09

This register is effective only if the digital ramp enable bit (0x01[19]) = 1, the frequency jump enable bit (0x01[14]) = 1 in the CFR2 register, and at least one of the no-dwell bits (CFR2[18:17]) is Logic 0. See the [Digital Ramp Generator \(DRG\)](#) section for details.

REGISTER MAP AND BIT DESCRIPTIONS

Table 25. Bit Descriptions for Lower Frequency Jump Register

Bit(s)	Mnemonic	Description
[31:0]	Lower frequency jump point	32-bit digital lower frequency jump value. During a rising frequency sweep, when the lower frequency jump value is reached, the output frequency jumps to the upper frequency jump value instantaneously and continues frequency sweeping in a phase-continuous manner. During a falling frequency sweep, when the upper frequency jump value is reached, the output frequency jumps to the lower frequency jump value instantaneously and continues frequency sweeping in a phase-continuous manner.

Upper Frequency Jump Register—Address 0x0A

This register is effective only if the digital ramp enable bit (0x01[19]) = 1, the frequency jump enable bit (0x01[14]) = 1 in the CFR2 register, and at least one of the no-dwell bits (CFR2[18:17]) is Logic 0. See the [Digital Ramp Generator \(DRG\)](#) section for details.

Table 26. Bit Descriptions for Upper Frequency Jump Register

Bit(s)	Mnemonic	Description
[31:0]	Upper frequency jump point	32-bit digital upper frequency jump value. During a rising frequency sweep, when the lower frequency jump value is reached, the output frequency jumps to the upper frequency jump value instantaneously and continues frequency sweeping in a phase-continuous manner. During a falling frequency sweep, when the upper frequency jump value is reached, the output frequency jumps to the lower frequency jump value instantaneously and continues frequency sweeping in a phase-continuous manner.

Profile Registers

There are 16 serial input/output addresses (Address 0x0B to Address 0x01A) dedicated to device profiles. Eight of the 16 profiles house up to eight single tone frequencies. The remaining eight profiles contain the corresponding phase offset and amplitude parameters relative to the profile pin setting.

To enable profile mode, set the profile mode enable bit in CFR2 (0x01[23]) = 1. The active profile register is selected using the external PS[2:0] pins.

Profile 0 to Profile 7, Single Tone Registers—0x0B, 0x0D, 0x0F, 0x11, 0x13, 0x15, 0x17, 0x19

Four bytes are assigned to each register.

Table 27. Bit Descriptions for Profile 0 to Profile 7 Single Tone Registers

Bit(s)	Mnemonic	Description
[31:0]	Frequency tuning word	This 32-bit number controls the DDS frequency.

Profile 0 to Profile 7, Phase Offset and Amplitude Registers—0x0C, 0x0E, 0x10, 0x12, 0x14, 0x16, 0x18, 0x1A

Four bytes are assigned to each register.

Table 28. Bit Descriptions for Profile 0 to Profile 7 Phase Offset and Amplitude Registers

Bit(s)	Mnemonic	Description
[31:28]	Open	Open.
[27:16]	Amplitude scale factor	This 12-bit word controls the DDS amplitude. Note that the OSK enable bit (0x00[8]) must be set to logic high to make amplitude adjustments.
[15:0]	Phase offset word	This 16-bit word controls the DDS phase offset.

REGISTER MAP AND BIT DESCRIPTIONS**USR0 Register—Address 0x1B***Table 29. Bit Descriptions for USR0 Register*

Bit(s)	Mnemonic	Description
[31:25]	Open	
24	PLL lock	This is a readback bit only. If Logic 1 is read back, the PLL is locked. Logic 0 represents a nonlocked state.
[23:0]	(See description)	These bits must always be programmed with the default values listed in the default column in Table 15 .

OUTLINE DIMENSIONS

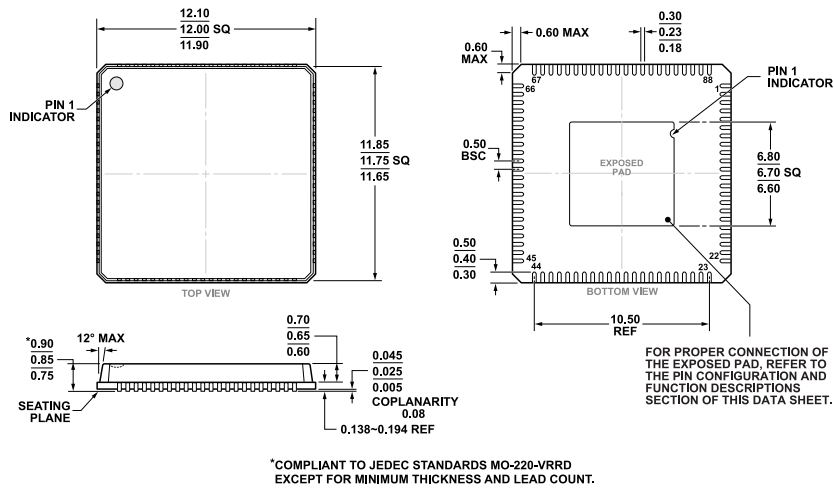

Updated: June 13, 2022

ORDERING GUIDE

Model ¹	Temperature Range	Package Description	Packing Quantity	Package Option
AD9914BCPZ	-40°C to +85°C	88-Lead LFCSP (12mm x 12mm w/ EP)		CP-88-5
AD9914BCPZ-REEL7	-40°C to +85°C	88-Lead LFCSP (12mm x 12mm w/ EP)	Reel, 400	CP-88-5

¹ Z = RoHS Compliant Part.

EVALUATION BOARDS

Table 30. Evaluation Boards

Parameter ¹	Description
AD9914/PCBZ	Evaluation Board

¹ Z = RoHS Compliant Part.