

# **PulseLARSEN** *Antennas*

## SourceBook® Version 13

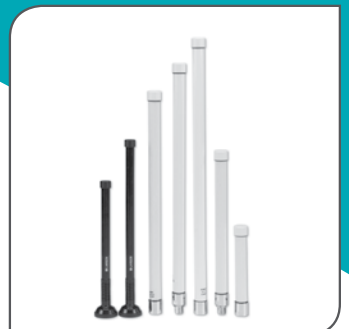

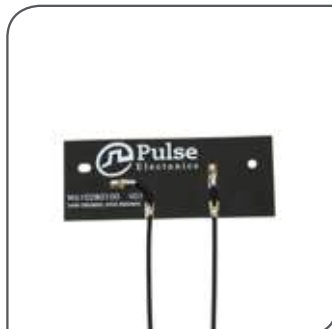

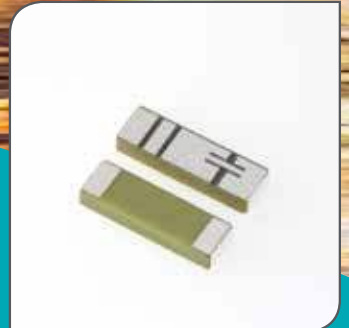
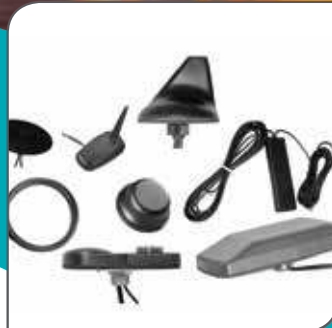
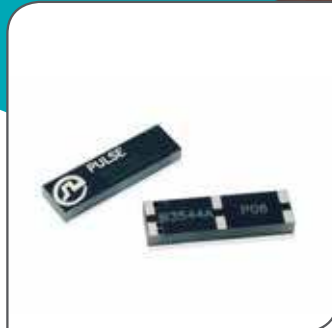

PulseLarsen Antennas is pleased to bring you the new, improved Antenna SourceBook (ASB), Volume 13. The goal of the ASB is to provide you with a “go to” source for all your antenna needs.

As the demand for wireless connectivity flourishes Pulse/Larsen is here with the needed solutions. We offer a unique far-reaching understanding of antenna and RF technology and have become the partner of choice for leading industry innovators. Pulse offers excellent value and outstanding quality products delivered from our high-volume production facilities. We offer a wide array of antennas covering 2G/ 3G/ 4G/5G , LTE, MiMo applications, WiFi, 2.4GHz, 5GHz, Zigbee, Bluetooth, GPS/ Glonass/ Beidou / Compass/ Galileo, any ISM frequency bands (169, 315, 433, 450, 868, 915, 2.4GHz), UHF, VHF, FM, DSRC, V2X, UWB and other applications.

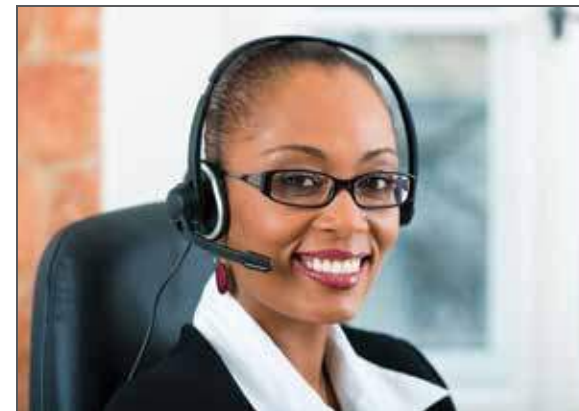
You can rely on PulseLarsen to be your trusted antenna partner. We have been in the antenna business over 50 years and have exceeded over 2 Billion antennas shipped during that time. We supply consistent high-quality products by owning and fully controlling our own factories in both China and the United States. On the following pages you will find our more popular antennas. For an up-to-the-minute view of our offering visit our website at [www.pulselarsenantennas.com](http://www.pulselarsenantennas.com).

**CONTACT US TODAY!**



-  Call us at **+1.800.ANTENNA**
-  Visit our website at **[pulselarsenantennas.com](http://pulselarsenantennas.com)**
-  Connect with us on twitter **[PulseLarsen1](https://twitter.com/PulseLarsen1)**

- How To Work With Us, Capabilities & Product Categories . . . . . 4-23**
- Selection Guides . . . . . 8-23**
- Embedded Antennas . . . . . 24-25**
- Internal Antennas . . . . . 26-28**
- External Antennas . . . . . 29-31**
- Portable Radio Antennas**
- KuLDUCKIE . . . . . 32-34**
- SPOTS! . . . . . 35-39**
- Low Band 27-136 MHz . . . . . 40**
- VHF 136-220 MHz. . . . . 41-43**
- UHF 406-512 MHz . . . . . 44-46**
- Multi Band VHF/UHF . . . . . 47**
- Tunable 1/4 Wave 136-512 MHz . . . . . 48**
- 700/800/900/1850 MHz . . . . . 49-52**
- GPS. . . . . 53-56**
- Multi-Band Data Antennas . . . . . 57-59**
- Outdoor Vehicular: LTE, 4G, Broadband . . . . . 60-61**
- Outdoor Antennas . . . . . 62**
- Base Station Antennas . . . . . 63**
- DAS . . . . . 64-69**
- Cable Assemblies/Mounts. . . . . 70-73**
- Connectors . . . . . 74-77**
- Parts/Accessories . . . . . 78-81**
- Coaxial Cables . . . . . 82-83**



**Pulse continues as an Innovative Leader!**

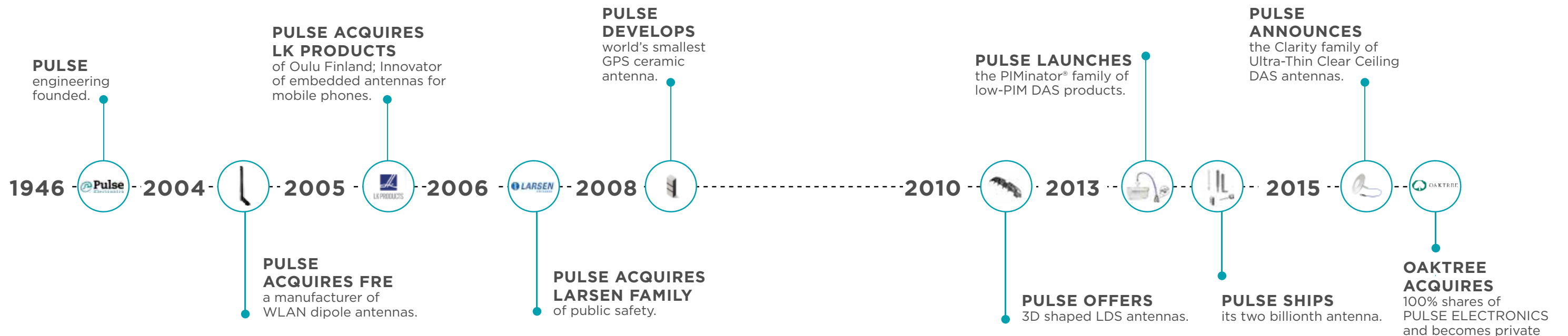



**Distribution**

PulseLarsen has partnered with the industry's leading wireless product distributors and sales representatives throughout the World. Our antennas are as close as a phone call away. Please find a list of our distributor and their live inventory on our website at: [www.pulselarsenantennas.com](http://www.pulselarsenantennas.com) and experience our "BUY NOW" button features.

Please find a list of our sales representatives and their dedicated territories at the following address:

**1-800-ANTENNA (268-3662)**

When you need an antenna, what better way than to remember 1-800-ANTENNA (268-3662). Our knowledgeable Customer Support staff is available to assist you.

**For our international customers:**

**PHONE** +1 - 360-944-7551

**EMAIL**

**Americas:** [antennas.us@pulseelectronics.com](mailto:antennas.us@pulseelectronics.com)

**Europe:** [antennas.eu@pulseelectronics.com](mailto:antennas.eu@pulseelectronics.com)

**Asia:** [antennas.as@pulseelectronics.com](mailto:antennas.as@pulseelectronics.com)

**Ordering**

At Pulse/Larsen we understand managing your business in today's rapidly changing wireless communications market can be complicated. We want to make the process of doing business with us as easy as possible.

Whether it's your first order or you've been doing business with us for a while, each and every customer is equally important to us. From our experienced customer service associates to the latest in communications technologies, Pulse/Larsen strives to exceed your expectations with every transaction.

To order products, contact one of our authorized distributors. For a list of distributors, visit our web site at [www.pulselarsenantennas.com](http://www.pulselarsenantennas.com).



**PULSE No-Nonsense™ Warranty**

Every effort is made to assure the integrity and long life of each Pulse product. In the unfortunate event a problem does occur, you will find us ready to make it right!

Duration of warranty is one year from date of purchase

Pulse will repair or replace without charge any Larsen antenna product which fails for any reason during the warranty period. Pulse is not responsible for any incidental or consequential damages due to failure of the antenna under this warranty or any implied warranty. This exclusion may not apply to all areas of the USA or Canada.

**Manufacturing Capabilities - Available Traditional Technologies**

- Stamping
- Plastic injection molding
- Heatstaking
- Welding (Spot, USW, Induction)
- Plasma Treatment
- Acoustic Module Testing (THD, SPL)
- Flexible Printed Circuit
- PAD printing, Painting
- In-House Ceramic Process
- Any Cable Assemblies
- Any Connector Mounts
- PIM Testing
- SMD Process
- Automatic Cable Stripping
- Epoxy resins and Glue deposition
- Plastic Dipping
- RF Testing
- Any Connector Mounts
- Auto Packaging and Labeling

**State of the Art - 3D Technologies**

- Laser Direct Structuring (LDS): 3D techniques using LPKF laser processing and Plating.
- Pulse FLUIDWRITER Technology: In-House 3d patented technology based on 3d deposition of conductive ink directly on plastic surface followed by low temperature curing process. Ideal process to build identical samples and mass production parts.

**Prototyping Abilities Worldwide (AMERICAS, EMEA, ASIA)**

- 3D printing plastic parts, FR4 or Stamping parts using LPKF machines, CNC, Plastisol Dipping techniques, Lathes, Milling machines...

**Testing Services - Testing Capabilities for Product Qualification and Design Validation**

**ELECTRICAL**

- S-Parameters using VNA up to 14GHz
- Impedance
- Insertion Losses
- Isolation
- Acoustic Parameters (THD, SPL)
- S.A.R. using Daisy 4 & 5
- Body Loading using phantom Hands and Heads
- Portable VNA for on-site Tuning with customers
- 3D radiation Patterns using Worldwide anechoic chambers Satimo/ETS)
- 3D RF simulation tools (CST, Optenni, Ibwave, AWR)
- WiFi Throughout testing using IXIA Chariot
- Expertise in advance RF behaviours with/without body loading/ Embedded in device or in Free Space

**MECHANICAL**

- Ability to use Solidworks, Catia VS, Pro E, ProgeCAD
- 3d fitting and rendering
- Mechanical Shock
- Solderability
- Tensile Strength
- Pull Force
- Torque testing
- Surface Profilometer

**ENVIRONMENTAL**

- ESD environment for Production &/or Design
- Humidity (to 90% RH)
- Moisture Resistance
- Thermal Shock
- Thermal Cycling with/without salt mist
- Aging
- Vibrations

NOTE: Full EMC Standards Compliance Testing in Germany for any vehicle size (Truck, Car, Tractor, Escalator, Agricultural machines and IoT).

\*\*\*\*\*  
 CHANGES / CONDITIONS: Continual research and development make it necessary for Pulse to reserve the right to make exceptions to or changes in policies, specifications and prices without notice.  
 \*\*\*\*\*

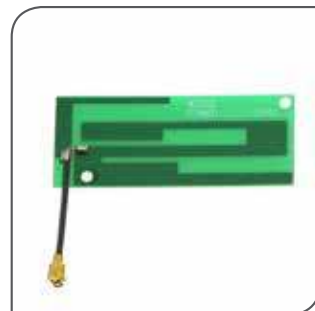
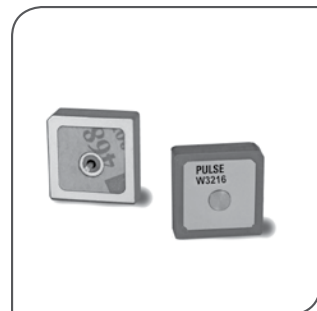

**Embedded**

Any antenna that can be surface mounted on the customer's PCB. In that category fall the helices, the Ceramic HTC antennas, the coils, and the composite material antennas.

**Internal**

Any antenna that are embedded in the customer's device but not visible from the outside, such as the cabled solutions based of FR4 and FPC, the active GPS modules & the NFC antennas.

**External**

That category is represented by the DAS antennas, the YAGI family, the Radome Omni family and the portables antennas.

**Outdoor/Vehicular**

Any antenna that can be mounted on top of a vehicle using connectors or a cable assembly with various types of connectors.

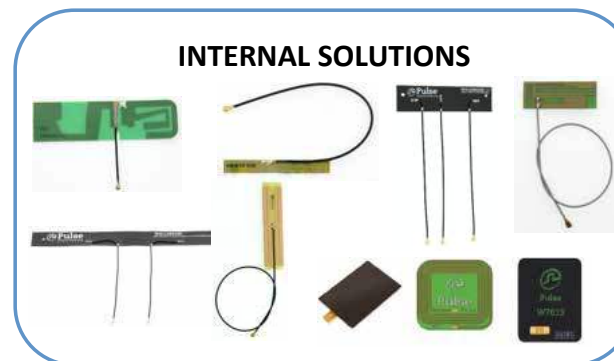

SMD / MINIATURE SOLUTIONS	<p><b>Embedded Applications</b></p> <p><b>Helical Antennas:</b> High Efficiency 3D molded antennas for SMD process. Ideal for Key-FOB products and other small PCB footprint areas (ISM 315MHz, 2.4GHz, 1.575GHz, ISM 433MHz).</p> <p><b>Ceramic Antennas:</b> In-house ceramic manufacturing process allowing world smallest and most efficient compact antennas. All frequencies available such as: WiFi, BT, BLE, Zigbee, ISM, GPS, WiFi &amp; GPS, GPS/GNSS/Beidou, Dual Band GSM.</p> <p><b>Composite Antennas:</b> Ideal for cellular type of applications (2G/3G/4G) requiring compact and efficient antenna form factors.</p>	<p><b>External Applications</b></p> <p><b>DAS Family:</b> Indoor LTE MIMO &amp; SISO World Class Solutions (CLARITY: ultra thin 8.3mm height, translucent, high cosmetic finish) &amp; (TRADITIONAL: Bulky Products) available with N, 4.3-10, mini-DIN connectors.</p> <p><b>Traditional Blade Antennas, Outdoor Radome Omnis and Yagi:</b> are available. Weather Proof IP65/67 Products Direct Mount with or w/o Bracket, Dipoles (Straight, Right angles), Radome Omni. All frequency bands available from 600MHz to 6GHz (Wlan, WiFi, GPS, 2G, 3G, 4G, LTE, UHF, VHF, Multi bands).</p>	DAS DUCKIES & OUTDOOR
	<p><b>Cabled Antenna Solutions:</b> Embedded within the device using low loss RF cables and standard connectors of your choice. Antenna substrate is based on FR4 and FPC. Antennas are mechanically fit within the design using snap-in features, adhesive, ribs or hooks.</p> <p><b>2G/3G Solutions:</b></p> <p><b>WiFi Solutions:</b></p> <p><b>2G/4G Solutions:</b></p> <p><b>NFC Solutions:</b> Wide Range of 13.56MHz antennas with various shapes and dimensions on FPC substrate.</p>	<p>Pulse/Larsen develops all types of mounting, cables and connector solutions for vehicular applications. Any requirements from OEM, ODM or after market customers are available from 50MHz to 6GHz. Any Mounting solutions (Direct, Magnet, Adhesive). Any cable type and length &amp; any connector types are available upon request.</p> <p><b>NMO Mount:</b> Pulse/Larsen is the patent holder of the world renowned NMO MOUNT facilitating the antenna installation for vehicular applications.</p>	



**IoT**

A massive market consisting of a network of physical devices.



**Transportation**

The Solution to Vehicle Communication.



**DAS**

Wireless Office Networking.



**Public Safety**

Communication antennas for the public safety sector.



**Critical Comm.**

Digital hand-held and mobile communications

App.	Type	Pulse Part number	Frequency range (MHz)	RL Min. (dB)	Peak Gain (dBi)			RF Performance Efficiency (%)		Antenna DIM. (LxWxH,mm)	ME requirement		Note	Availability
					Peak	Band edges	Peak	Band edges	GC-area (L x W,mm)		Evaluation Board Size (L x W,mm)			
868MHz (868MHz-870MHz)	Ceramic chip	W3000	868-870	-15	-1.4	-1.5	30	29	7 x 1.6 x 1.6	20 x 9.50	40 x 20	Vertical, tuned by stripline on PCB	Stock	
		W3013	868-870	-11	1.5	1.4	65	64	10 x 3.2 x 4.0	10.80 x 8.25	80 x 37	Center edge	Stock	
		W3016	868-870	-19	-2.2	-2.5	25	23	10 x 3.2 x 4.0	11.50 x 7	25 x 25	Corner, Small GC-area and PCB	Stock	
915MHz (902MHz-928MHz)	Helical	W3117	869-894	-9	0	-1.3	56	40	12.4 x 8 x 2.5	8 x 40	100 x 40	Horizontal, Center top	Leadtime	
		W3118A	869-894	-9	0	-1.4	52	38	2.5 x 8 x 8	6 x 11	100 x 40	Vertical, Corner	Leadtime	
	Ceramic chip	W3012	902-928	-6	2	0.5	70	50	10 x 3.2 x 4	10.80 x 8.25	100 x 37	Center edge	Stock	
W3014		880-960	-7	-0.5	-1	45	40	10 x 3.2 x 1.5	40 x 16	96 x 40	Center Top	Stock		
Combo 868/915MHz and 2.4GHz	Helical	W3112A	902-928	-10	0.9	-0.3	67	50	2.5 x 8 x 8	6 x 11	100 x 40	Vertical, Corner	Stock	
		W3113	902-928	-10	0.8	-0.3	66	51	12.4 x 8 x 2.5	8 x 40	100 x 40	Horizontal, Center top	Stock	
	Direct PCB	W3331	863-928	-6	1.7	0.9	64	53	45 x 10 x 0.8	45 x 4.5	119 x 102	Corner, Small GC-area and PCB, Dual feeds	Contact to sales for datasheet	
			2400-2500	-12	4	1.5	85	69						
	Direct PCB	W3333	863-928	-8	2.4	1.8	75	-	40 x 15 x 0.8	40 x 4.5	119 x 102	Corner, Small GC-area and PCB, Dual feeds	Contact to sales for datasheet	
			2400-2500	-12	4.5	3.0	85	66						
433MHz	Ceramic chip	W3015	433 +/- 1	-10	1.6	-	78	-	10 x 3.2 x 4.0	10.60 x 14	200 x 37	Center edge	Leadtime	
		W3127	433-435	-15	-2.9	-	-	-	35.35 x 9.90	8 x 40	100 x 40	Center Top	Stock	
315 MHz	Helical	W3126	315	-10	-5	-	-	-	35.35 x 9.90	8 x 40	100 x 40	Center Top	Stock	
169 MHz	Helical	W3100	169MHz	-10	-4	-	55	-	91 x 9.8	-	95 x 45	coil on free space	Leadtime	



Note: 1. ISM application for 902MHz-928MHz band (center frequency 915MHz). 2. Applications from ECA chart for 862MHz-890MHz. (a) Alarms: 868.6-869.7MHz, (b) RFID: 865-868MHz, (c) Tracking, tracing, and data acquisition: 870-875.6MHz, and (d) Wireless audio/ multimedia: 863-865MHz. 3. "Stock" Stocked parts are typically available from Pulse distribution partners immediately.

App.	Type	Pulse Part Number	Operating Frequency (MHz)	RF Performance					ME requirement			Note	Availability
				RL Min. (dB)	Peak Gain (dBi)		Efficiency (%)		Antenna DIM. (LxWxH,mm)	GC-area (L x W,mm)	Evaluation Board Size (L x W,mm)		
					Peak	Band edges	Peak	Band edges					
Single WiFi, BT, Zigbee	Ceramic chip	W3000	2400-2483.5	-18	2.5	2.1	65	55	7x1.6x1.6	6.00x11.00	40x11	3 Matching components Horiz. mount	Stock
				-12	2.2	1.5	53	45		6.00x20.00	30x20		
		W3001		-6	1.5	0.5	75	60	10x3.2x4.0	10.80x6.25	80x37	On Ground solution	Stock
		W3008		-8	1.7	0.7	70	55	3.2x1.6x1.1	4.00x4.25	80x37		Stock
		W3008C		-11	2.2	1.9	75	70	3.2x1.6x1.1	4.00x6.25	80x37		Stock
		W3043		-12	4		70		3.2x1.6x1.1	12x20	37x20	Small PCB size	Leadtime
		W3092		-6	2	0	60	43	2x1.2x0.55	8x2.5	110x55	Small antenna size	Contact to sales for datasheet
	Helical	W3108		-8	1.5		50		5.0x2.5x5.5	7.50x5.50	100x40	Vertical SMD Corner @	Stock
Dual WiFi	Ceramic chip	W3006	2400-2483.5	-8	3.2	2.7	70	65	10x3.2x1.5	11.60x6.00	80x37		Stock
			5150-5850	-10	4.2	3.0	80	70					
		W3078	2400-2483.5	-10	1.7	1.0	65	55	3.2x1.6x1.1	11.15x6.40	80x37	@ Corner	Stock
			4950-5850	-6	4.3	3.7	80	55					
		W3079	2400-2483.5	-13	2.5	1.3	72	60	3.2x1.6x1.1	11x6	80x37	Center	Stock
			4950-5850	-8	5.7	3.3	78	55					
		W3056	2400-2483.5	-8	3.2	2.5	80	70	10x3.2x1.5	10.80x6.25 (Notch)	100x40	Single feed and 2.4GHz WiFi	Stock
	1575.42+10	-10	2.5	1.5	75	65							
W3064C	2400-2483.5	-11	-0.7	-1.7	80	70	10x3.2x1.5	10.80x6.40 (Divided)	96x45	Dual feed and 2.4GHz WiFi	Contact to sales for datasheet		
	1575.42+10	-15		-2.0	70	60							
	2400-2483.5	-11	2.5	1.5	85	80							
		4950-5850	-6	3.5	1.0	70	50						
Combo GPS+WiFi or ISM 868/915 + WiFi	Ceramic chip	W3095	1559-1610.5	-10	1.5	0.8	75	60	10x3.2x1.5	17.80x6.45	70x35	Dual feed and Dual WiFi+GPS/Glonass/Beidou	Stock
			863-928	-8	1.5	0.8	67	55					
		W3320	2400-2500	-6	3.4	1.4	61	45	10x3.2x2	4.6x3.95	120x50	Center, Dual feed	Leadtime

\*NOTE: 1. Recommended minimum GND dimensions of PIFA type and Monopole's are roughly 40x20mm and 30x20mm (or 40x11mm), respectively. Need to construct matching values to optimize antenna performance on surrounding mechanics and materials. 2. Pulse offers very unique GPS+WiFi combo antennas on single ceramic chip (10x3.2x1.5mm). There are three different types of combo antennas. W3056 (2.4G Wifi +GPS, single feed), W3064C (2.4G WiFi+GPS, dual feed), and W3095 (2.4G and 5G Wifi +GPS/Glonass/Beidou, dual feed). 3. "Stock" Stocked parts are typically available from Pulse distribution partners immediately.

App. Type	Pulse Part number	Operating Frequency (MHz)	RF Performance							ME requirement			Note	Availability	
			RL Min. (dB)	RHCP Gain (dBic)		Linear Gain (dBi)		Efficiency (%)/(dB)		Antenna DIM. (LxWxH,mm)	GC-area (L x W,mm)	Evaluation Board Size (L x W,mm)			
				Peak	Band edges	Peak	Band edges	Peak	Band edges						
GPS Only	Ceramic chip	1575.42 +/-10	W3000	-15	-3.9	-4.1	0.3	0	50/-3	45/-3.5	7 x 1.6 x 1.6	6 x 20	30 x 20	3 Matching components	Stock
				-12	-3.5	-3.9	0.1	-0.2	50/-3	45/-3.5		6 x 11	40 x 11		
			W3009	-11	0.2	-0.6	3	2.3	83/-0.8	70/-1.5	10 x 3.2 x 4.0	10.80 x 6.25	80 x 37	On Ground shunt 3.3pF	Stock
	W3011	-12	0.85	0.5	3.4	3	85/-0.7	80/-1	3.2 x 1.6 x 1.1	4.00 x 4.25	80 x 37	w/o matching	Stock		
	Patch	W3099	-14	3.5	-	-	-	-	-	25 x 25 x 4	-	70 x 70	AR: 3, V01; A	Contact to sales for datasheet	
	W3213	-13	-1.5	-	-	-	-	-	13 x 13 x 4	-	30 x 30	AR: 3, V02; C	Stock		
GPS, Glonass, & Beidou	Ceramic chip	1559-1591 1575.42 +/-10 and 1598-1610	W3110	-16	-2.1	-2.4	1.3	0.7	47/-3.3	43/-3.7	5.0 x 2.5 x 5.5	7.50 x 5.50	100 x 40	Vertical SMD, @ Corner	Stock
			W3000	-18	-0.2	-	2.4	1.5	70/-1.55	65/-1.9	7 x 1.6 x 1.6	6 x 10	80 x 37	3 Matching components, Horiz. Mount + @Corner	Stock
				-12	1	0	3	2.2	75/-1.25	70/-1.5				@ Position1 shunt 3.3pF	
	W3010	-12	1.5	0.4	3	1.8	70/-1.55	50/-3.0	10 x 3.2 x 2	10.80 x 6.25	80 x 37	@ Position2 shunt 2.2pF	Stock		
	Patch	W3011A	-16	1	-0.4	3.7	2.5	88/-0.6	70/-1.5	3.2 x 1.6 x 1.1	4.00 x 6.25	80 x 37	Shunt 1.8pF	Stock	
	W3062A	-10	0	-0.5	2.5	2.0	80/-1	60/-2.1	7 x 1.6 x 1.6	7.80 x 5.25	80 x 37	Shunt 2.2pF	Stock		
	W3216	-7	-2	-	-	-	60	50	13 x 13 x 5	-	50 x 50	Shunt 1.5pF V02; C	Stock		
WiFi and GPS Combo	Ceramic chip	2400-2483.5 1575.42+ 10	W3056	-8	-	-	3.2	2.5	80	70	10 x 3.2 x 1.5	10.80 x 6.25 (Notch)	100 x 40	Single feed and 2.4GHz +GPS	Stock
				-10	-	-	2.5	1.5	75	65					
	W3064C	2400-2483.5	-11	-	-	-0.7	-1.7	80	70	10 x 3.2 x 1.5	10.80 x 6.40 (Divided)	96 x 45	Dual feed and 2.4GHz +GPS	Contact to sales for datasheet	
		1575.42 + 10	-15	-	-	-2.0	70	60							
	W3095	2400-2483.5	-10	-	-	2.7	1.5	85	80						
	4950-5850	-6	-	-	3.7	1.0	73	53	10 x 3.2 x 1.5	17.80 x 6.45	80 x 50	Dual feed and Dual WiFi + GPS/Glonass/Beidou	Stock		
	1559-1610.5	-8	-	-	1.7	0.7	75	62							

NOTE: 1. Recommended minimum GND dimensions of PIFA type and Monopole are roughly 40x20mm and 30x20mm (or 40x11mm), respectively. Need to construct matching values to optimize antenna performance on surrounding mechanics and materials. 2. Pulse offers very unique GPS+WiFi combo antennas on single ceramic chip (10x3.2x1.5mm). There are three different types of combo antennas. W3056 (2.4G Wifi +GPS, single feed), W3064C (2.4G WiFi+GPS, dual feed), and W3095 (2.4G and 5G Wifi +GPS/Glonass/Beidou, dual feed). 3. "Stock" Stocked parts are typically available from Pulse distribution partners immediately.

App	Type	Pulse Part Number	RF Performance				ME requirement			Note	Availability		
			Frequency range (MHz)	RL Min. (dB)	Peak Gain (dBi)		Efficiency (%) / (dB)		Antenna DIM. (LxWxH,mm)			GC-area (L x W,mm)	Evaluation Board Size (L x W,mm)
					Peak	Band edges	Peak	Band edges					
LTE	Composite	W3796	698-960	-6	1.5 (Avg. peak gain)		65 (Avg.)		40 x 7 x 3	40.6 x 15	120 x 40.6	- Top mount: Horizontal - Matching: SE3.3nH+SH0.7pF; SH6.8nH	Stock
			1427.9-1660.9	-5.5	2 (Avg. peak gain)		55 (Avg.)						
			1695-2200	-6	5.5 (Avg. peak gain)		75 (Avg.)						
			2300-2700	-6	5 (Avg. peak gain)		70 (Avg.)						
Penta Band	Composite	W3544A	824-960	-3.7	0.5	1.8	65	44	7.65 x 26 x 3	21x33.5 (W3544A)	110 x 50	1. Corner mount (vertical). 2.matching: *SE12nH	Stock
			1710-1880	-4.6	2.9	2.3	74	45					
			1850-1990	-8.6	2.4	1.7	74	64					
			1920-2170	-5.6	2.2	1.1	68	60					
Penta Band	Composite	W3544B	824-960	-6.5	1	-0.7	70	53	7.65 x 26 x 3	50 x 18 (W3544B)	110 x 50	1. Top mount (Horizontal) 2.matching: 10nH	Stock
			1710-1880	-5.7	2.7	1.7	77	59					
			1850-1990	-9.3	2	1	77	69					
			1920-2170	-5	1.8	0.2	71	58					
Quad band (US)	Composite	W3073	824-894	-4.7	0.4	-2.6	51	28	10 x 3.2 x 4	40 x 10	105 x 40	1. Matching: SE10nH+ SE12nH+SH12nH. 2.Tuning strip on PCB.	Stock
			1710-1880	-3.5	2.3	0.7	59	40					
			1850-1990	-5.9	2.5	1.6	59	54					
			1920-2170	-3.3	2.2	0.9	58	46					
Quad band (EU)	Ceramic	W3073	880-960	-3.8	1	-1.8	60	34	10 x 3.2 x 4	40 x 10	105 x 40	1. Matching: *SE10nH+ *SE10nH+ *SH15nH. 2.Tuning strip on PCB.	Stock
			1710-1880	-4.9	2.9	2	70	54					
			1850-1990	-8	2.9	2.5	71	62					
			1920-2170	-4.4	2.8	2.3	67	59					
Dual band (EU)	Ceramic	W3070	880-960	-5.1	1.2	-0.4	65	47	10 x 3.2 x 2	40 x 10	95 x 40	Matching: *SE18nH+ *SE10nH	Stock
			1710-1880	-5.7	2.5	1.5	60	50					

NOTE: 1. "Stock" Stocked parts are typically available from Pulse distribution partners immediately. 2. \* SE = Series and \*SH = Shunt



App.	Type	Pulse Part Number	Operating Frequency (MHz)	RF Performance				Antenna DIM. (LxWxH,mm)	ME requirement		Connector Type	Note	Availability
				RL Min. (dB)	Peak Gain (dBi) Peak	Band edges	Efficiency (%) / (dB) Peak		Cable Length from PCB edge/ Diameter, mm				
ISM 868/915	FPC	W3312B0100	860-930	-8	2.3	-	50 (Avg.)	75 x 15	L:100 / D:1.13	IPEX MHF 20278	Alternative: W3502, W3538, W3501	Contact to sales for datasheet	
	PCB	W3332B0100	863-928 2400-2500	-5 -10	0.2 4.1	-	55 (Avg.) 64 (Avg.)	82 x 15 x 0.56	L:150 / D:1.13	IPEX MHF 20278	ISM 868/915 and 2.4GHz WiFi (two feed cables). Isolation: <-11dB.	Contact to sales for datasheet	
WIFI, BT, Zigbee	PCB	W3525B039	2400-2483.5	-10	2	0.6	65	48 x 11 x 0.8	L:100 / D:1.13	IPEX MHF 20278		Stock	
	PCB	W3593B0100	4900-5850	-10	2	0.5	70	45 x 7 x 0.8	L:100 / D:1.13	IPEX MHF 20278		Stock	
	PCB	W3513B0212	2400-2500 4900-5850	-13 -10	2 2.7	1.4 0.4	70/-1.5 67/-1.8	16 x 70 x 0.9	L:212 / D:1.13	IPEX MHF 20278		Stock	
	FPC	W3315B0100	2400-2500 4900-5875	-10 -10	2 5	-	65 76	45 x 6 x 0.1	L:100 / D:1.13	IPEX MHF-A13 20428-001R	Measured with 2mm PC/ABS plastic	Stock	
MIMO WIFI	FPC	W3334B0150	2400-2500 4900-5900	-10 -10	4 5	-	52 (Avg.) 80 (Avg.)	14 x 5 x 0.1	L:150 / D:1.13	IPEX MHF 20278	Measured with 1.5mm PC/ABS plastic	Contact to sales for datasheet	
	FPC	W6102B0100	2400-2500 4900-5900	-10 -10	1 (Avg.) 5 (Avg.)	-	40 (Avg.) 75 (Avg.)	50 x 20 x 0.1	L:100 / D:1.13	IPEX MHF 20278	Measured with 1.5mm PC/ABS plastic	Contact to sales for datasheet	
	FPC	W6103B0100	2400-2500 4900-5900	-10 -10	4.5 (Avg.) 5 (Avg.)	-	52 (Avg.) 80 (Avg.)	80 x 20 x 0.1	L:100 / D:1.13	IPEX MHF 20278	Measured with 1.5mm PC/ABS plastic	Contact to sales for datasheet	
	PCB	W3502B0020	824-960 1710-1990	-6 -4	2 2.4	0.8 -0.4	78/-1.2 80/-0.95	43 x 17 x 0.5	L:20 / D:1.13	IPEX MHF 20278	80mm ground plane with 5mm gap inside plastic box	Stock	
3G	PCB	W3538B0200	824-960 1710-2170	-6 -6	- -	-	57 71	40 x 15 x 0.7	L:200 / D:1.13	IPEX MHF 20278	On plastic PC plate with test ground	Stock	
	PCB	W3501B0140	824-960 1710-1990	-7 -8	1.5 4.2	0.8 2.8	61 71	87 x 25 x 0.2	L:140 / D:1.13	IPEX MHF 20278	Test unit : 150x100x40. W/ adhesive: W3571B0140.	Stock	
	FPC	W3554B0140	698-798 824-960 1710-2690	-5 -7 -8	1.5 1.8 3.9	-0.6 0.4 1.9	75 80 86	120 x 30 x 0.2	L:140 / D:1.13	IPEX MHF 20278	Connected on a test board 120x120 with 10mm gap	Stock	
MIMO 4G (LTE)	FPC	W6112B0100	698-960 1428-2700 3400-3600	-10 -8 -10	4.3 (Avg.) 3.8 (Avg.) 4 (Avg.)	-	55 (Avg.) 68 (Avg.) 65 (Avg.)	224 x 20 x 0.1	L:100 / D:1.13	IPEX MHF 20278	Measured with 1.5mm PC/ABS plastic	Contact to sales for datasheet	

Note: 1. I-PEX MHF connector is U.FL compatible. Receptacle PN of IPEX MHF 20278-112R-13: 20279-001E (3pad), 20441-001E(4pad). Cable length is starting at an edge of PCB. 3. See datasheets for available cable lengths or contact the factory. 4. "Stock" Stocked parts are typically available from Pulse distribution partners immediately.

App.	Pulse Part number	Operating Frequency (MHz)	RF Performance				LNA		Antenna Dimension (mm)	Overall Dimension (mm)	ME requirement		Note	Availability
			Antenna Element	Gain (dB)	NF (dB)	Current (mA)	VCC (Vdc)	Connector type			Coaxial Cable (Length; Diameter)			
GNSS (GPS, Glonass, BeiDou, and Galileo)	GPSGB1315	1561 +/- 2.046, 1575.42 +/- 10.23, and 1602.5625 +/- 4 MHz	2	-1+1	15+ -2	<2.4	<6	3.3-5+ -0.5	13x13x5	16x17x8.15	IPEX MHF 20278	L:100; D:1.13	Contact to sales for datasheet	Stock
	GPSGB1330		2	-1+1	30+ -2	<2.4	<6	3.3-5+ -0.5	13x13x5	16x17x8.15	IPEX MHF 20278	L:100; D:1.13	Contact to sales for datasheet	Stock
	GPSGB2515		2	1+1	15+ -2	<2.4	<6	3.3-5+ -0.5	25x25x4	30x30x8	IPEX MHF 20278	L:100; D:1.13	Contact to sales for datasheet	Stock
	GPSGB230		2	1+1	30+ -2	<2.4	<6	3.3-5+ -0.5	25x25x4	30x30x8	IPEX MHF 20278	L:100; D:1.13	Contact to sales for datasheet	Stock

Note: 1. Further detailed specs such as 'Out of band rejection' of LNA can be found on a datasheet.



**PulseLarsen Antennas**

PulseLarsen also provides TS16949 GPS Patches for the Tier 1 automotive business as follows:

**W3223:** Center Pin, 25x25x4mm

**W3224:** Surface Mount, 18x18x4 mm

**W3225:** Surface Mount, 25x25x4mm



**INTERNAL ACTIVE GPS MODULES STARTING ON PAGE 27.**

App.	Type	Pulse Part number	RF Performance									Mechanical requirement		Note	Availability
			With matching network				Without matching network (Bare coil)					Package type	Dimension (in/mm)		
			Frequency (MHz)	Reading distance EMVCo (mm)	Reading Distance Grid Scan (Avg.,mm)	Impedance (ohm)	Self resonant frequency (MHz)	Inductance (uH)	Resistance (ohm)	Q-Factor					
NFC	Flex only	W7001	13.56	40	33	50/80	100	0.9	1.55	49	A	0.98 x 0.98 x 0.005 (25 x 25 x 0.12)	Without a GND near antenna	Stocked	
	Flex with Ferrite	W3579	13.56	40	28	50/80	42	1.6	3.60	37.8	B	1.38 x 1.97 x 0.012 (50 x 50 x 0.30)		Stocked	
		W7013	13.56	20	25	50/80	71.5	1.05	2.70	33	C	1.18 x 0.98 x 0.014 (30 x 25 x 0.36)	On GND solution	Stocked	
	Flex with twisted pair cable + connector	W7000	13.56	-	36	50	75.5	1.27	2.20	49	F	1.69 x 1.34 x 0.005 (43x 34 x 0.11)	Adhesive tape under coil included	Lead time	
		W7002	13.56	40	35	50/80	89	0.65	0.95	57	D	3.72 x 2.24 x 0.14 (94.6 x 56.8 x 3.65)	Optimized for metal proximity within the device	Stocked	
	WiFi and NFC combo	Trace on PCB	W5100	13.56 2400-2483.5	- RL Min. (dB): -8	-	50	65.9	0.95	-	44	E	1.57 x 1.57 x 0.05 (40 x 40 x 1.2)	Test setup over 80x80 mm metal GP	Lead time
W5101			13.56 2400-2483.5	- RL Min. (dB): -8	-	50	57.6	1.13	-	46	E	1.77 x 1.77 x 0.05 (45 x 45 x 1.2)	Test setup over 80x80 mm metal GP	Lead time	



NOTE: 1. Wire assembly option: Picoblade connector with wire. 2. "Stock" Stocked parts are typically available from Pulse distribution partners immediately.

	Type	RF Performance				Mechanical requirement				Note	Availability		
		Pulse Part number	Frequency range (MHz)	RL Min. (dB)	Peak Gain (dBi)	Height (mm) straight (Bent)	Diameter(mm) Max (Min)	Package type	Connector			IP-rate	
ISM	Stick/Swivel	W1063	868-928	-7.5	3	195 (172)	13 (6)	B	RP-SMA		Stock		
		W1063M	902-928	-10	3	195 (172)	13 (6)	B	SMA (m)		Leadtime		
	Stick/ no Swivel	W5012	868-928	-8	2	179	10	A	RP-SMA		Stock		
		W5017	868-928	-8	2	179	10	A	SMA (m)	IP65	Stock		
		W5021	868-928	-8	2	171	10	G	RP-SMA (Right angle)		Leadtime		
WIFI (2.4GHz)	Stick/Swivel	W1010	2400-2500	-10	2	108 (86)	10 (7.8)	B	SMA(m)		Stock		
		W1030	2400-2500	-10	2	108 (86)	10 (7.8)	B	RP-SMA		Stock		
		W1027	2400-2500	-11	3.2	136 (110)	10 (6)	C	RP-SMA		Stock		
		W1037	2400-2500	-10	3.2	197 (170)	13.2 (7.4)	C	RP-SMA		Stock		
		W1038	2400-2500	-10	3.2	197 (170)	13.2 (7.4)	C	RP-SMA	Color option (Grey)	Stock		
		W1059	2400-2500	-10	5	195 (154)	13 (6)	C	SMA (m)		Stock		
	Stick/ no Swivel	W5001	2400-2500	-10	1.5	128	10 (6)	G	RP-SMA (Right angle)		Stock		
		W5010	2400-2500	-10	1.5	130	10 (6)	A	RP-SMA	IP65	Stock		
		W5011	2400-2500	-10	1.5	130	10 (6)	A	SMA (m)		Stock		
		W5039	2400-2500	-10	2	94	10 (6)	F	RP-SMA	IP67	Leadtime		
		WIFI (5GHz)	Stick/Swivel	W1028B	5150-5850	-9	2	136 (114)	9.2 (6)	C	RP-SMA		Stock
				W1043	2400-2500; 5150-5850	-10	2	157 (130)	17.6 (13)	E	RP-SMA		Stock
Blade/ Swivel	W1044		2400-2500; 5150-5850	-10	2	157 (126)	17.6 (13)	E	SMA (m)		Leadtime		
	SPDA17RP2400/5900		2400-2500; 4900-5900	-10	0.8; 5.9	175 (150)	21.8 (13.7)	H	RP-TNC		Stock		
Stick/ no Swivel	W5028		2400-2500; 5150-5850	-10	0	128	10 (6)	G	RP-SMA (Right angle)	IP65	Stock		
	SPDA24850/1900		824-894; 1850-1990	-7.5	0; 1.5	176 (147)	21.8 (13.7)	H	SMA (m)		Leadtime		
2G	Blade/ Swivel	SPDA17850/1900	824-894; 1850-1990	-10	0; 1.2	176 (147)	21.8 (13.7)	H	TNC		Leadtime		
		W1900	824-960, 1710-2170	-4;-6	0.5; 2.5	49	8	D	SMA (m) (Right angle)		Stock		
		W1902	824-960, 1710-2170	-4;-6	0.5; 2.5	49	8	D	RP-SMA (Right angle)		Stock		
3G	Stick/ no Swivel	W1910	824-960, 1710-2170	-4;-6	0.5; 2.5	49	10.4	F	SMA (m)	Tested on ground plane (70x50mm)	Stock		
		W1911	824-960, 1710-2170	-4;-6	0.5; 2.5	49	10.4	F	RP-SMA		Stock		
4G	Blade/ Swivel	SPDA17806/ 2170	806-960; 1710-2170	-7.5	0.5; 0.5	192 (159)	23.8 (15.7)	H	TNC	MediumGrey	Stock		
		SPDA24700/ 2700	698-960; 1710-2170; 2500-2700	-7.5	0.6; 1.5; 3.4	223 (192)	23.8 (15.6)	H	SMA (m)		Stock		
	Blade/ Swivel	W5084K		-8	1.5; 2.5	229 (198)	29 (15.5)	H	SMA (m)	IP65	W5084 (TNC)		
		W5095K	698-960; 1447-1510; 1710-2170; 2500-2700	-9	2.0; 3.0	229 (198)	43 (15.5)	H	SMA (m)	IP65	W5095 (TNC)	Contact to sales for datasheet	

EMBEDDED ONTO / SOLDERED TO PCB

- Antenna Technology: Ceramic monopoles, ceramic PIFA, ceramic patch, helical; stamped metal, composite.
- Frequencies: WLAN(Wi-Fi), Zigbee, Bluetooth, ISM, GPS, 3G/4G LTE, Multi bands.
- Applications: OEM equipment, medical devices, security systems, tracking and monitoring devices, handhelds, meter reading, smart devices, sensors, wearables, fitness, beacons, and more.

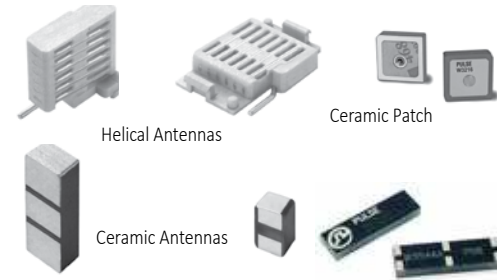

Pulse offers a wide range of surface mount antennas (SMD) for wireless device applications. Pulse ceramic technology results in robust antenna designs that have outstanding performance. These antennas have an inherent immunity to surrounding antenna signals and hand-effect, which makes them exceptionally suitable solutions for small hand-held or wall-mount devices with multiple antennas. Pulse helical antenna technology provides high-performance antennas in a small package that can be easily deployed. Our composite antennas offer the most frequency bands per embedded technology. These ceramic, helical, and composite antennas require minimal ground plane removal for operation, which means saved board space and economical implementation. The SMD compatibility of Pulse’s antenna products makes them simple and easy to mount.

CERAMIC								
Application	Part No.	Size <sup>4</sup> (mm)/ Type	Mount Type <sup>3</sup> (mm)	Frequency Range (MHz)	RHCP Gain <sup>5</sup> (dBic)	Max Gain (dBi)	Efficiency (%/dB)	Return Loss (dB MIN)
WiFi	W3001	10x3.2x4mm Ceramic	SMD, GC 10.8x6.25	2400	N/A	1.5 (peak)	75/-1.25	-6
WiFi Dualband	W3079	3.2x1.6x1.1 Ceramic	SMD, GC area 11.00x6.00	2400-2483.5 / 5150-5850	N/A	2.4 (peak) / 5.7 (peak)	72% (peak) / 78% (peak)	-13 / -8
WiFi Dualband	W3006	10.0x3.2x1.5 Ceramic	SMD, GC area 11.60x6.00	2400-2483.5	N/A	3.2 (peak) / 4.2 (peak)	70% (peak) / 80% (peak)	-8 / -10
Bluetooth/WiFi	W3092	2.0x1.2x0.55 Ceramic	SMD, GC area 8.00x2.50	2400-2483.5	N/A	2,2 (peak)	75/-1.3 (peak)	-11
Bluetooth/WiFi	W3008C	3.2x1.6x1.1 Ceramic	SMD, GC area 4.00x6.25	2400-2483.5	N/A	2,2 (peak)	75/-1.3 (peak)	-11
GPS	W3009	10.0x3.2x4.0 Ceramic	SMD, GC area 10.80x6.25	1575.42 ±10	0.7 (peak) / 0.3 (band edges)	3 (peak)	80/-1.25 (peak)	-10
ISM	W3013	10x3.2x4 Ceramic	GC area 10.8x8.25	868-870	--	1.5	65	-11
WiFi & GPS	W3056	10x3.2x1.5 Ceramic	GC area 10.8x6.25 (Notch)	2400-2483.5 / 1575.42	--	3.2 / 2.5	80 / 75	-8 / -10
WiFi & GPS	W3064C	10x3.2x1.5 Ceramic	GC area 10.8x6.4 (Divided)	2400-2483.5 / 1575.42	--	-0.7 / -1	80 / 70	-11 / -15
GPS	W3213	13x13x4 Patch	--	1575.42	-1.5	--	--	-13
GPS	W3216	13x13x5 Patch	--	1575.42	-2	--	60	-7
GPS	W3099	25x25x4 Patch	--	1575.42	3.5	--	--	-14

1. All antennas are RoHS Compliant  
 2. Operating temperature -40°C to +85°C  
 3. GC = Ground Clearance, mm  
 4. Length x Width x Height  
 5. Monopole antenna performance is linked to different tuning circuit recommendations for the variety of applications. Consult the data sheet for more information

ANTENNAS FOR EMBEDDED SURFACE MOUNTING APPLICATIONS (continued)

CERAMIC (CONTINUED)								
Application	Part No.	Size (mm)/ Type	Mount Type <sup>3</sup> (mm)	Frequency Range (MHz)	RHCP Gain (dBic)	Max Gain (dBi)	Efficiency (%/dB)	Return Loss (dB MIN)
GPS/Glonass & Beidou	W3062A	7x1.6x1.6 Ceramic	GC area 7.8x5.25	1559-1591 & 1598-1610	0	2.5	80 / -1	-10
Dual Band (EU)	W3070	10x3.2x2 Ceramic	GC area 40x10	880-960 / 1710-1880	--	1.2 / 2.5	65 / 60	-5.1 / -5.7
Dual WiFi	W3078	3.2x1.6x1.1 ceramic	GC area 11.15x6.4	2400-2483.5 / 4950-5850	--	1.7 / 4.3	65 / 80	-10 / -6
WiFi & GPS	W3095	10x3.2x1.5 Ceramic	GC area 17.8x6.45	2400-2483.5 / 4950-5850 / 1559-1610.5	--	2.7/3.7/1.7	85/53/62	-10/-6/-8
ISM, or GPS, or GPS/Glonass/BD	W3000 <sup>5</sup>	7x1.6x1.6 tuneable monopole	See datasheet	868-870; 1559-1591 & 1598-1610; 1575.4	See datasheet	See datasheet	See datasheet	See datasheet
GPS	W3010	10.0x3.2x2.0 Ceramic	SMD, GC area 10.80x6.25	1575.42 ±10	-0,2 (peak)	2,8 (peak)	75/-1,25 (peak)	-18
GPS	W3011/A	3.2x1.6x1.1 Ceramic	SMD 4x4.25/6.25	1575.42 ±10	0.85 (peak)	3.4 (peak)	85/-0.7 (peak)	-12
ISM 900	W3012	10x3.2x4 Ceramic	SMD GC area 10.80x8.25	902-928	N/A	2 (peak)	70/- 1.55 (peak)	-6
ISM 868/915 Monopole	W3014 <sup>5</sup>	10x3.2x1.5 Ceramic	SMD GC area 40x16	848-888/ 895-935	N/A	1.55 (peak)	45/- 4.5 (peak)	-6
Zigbee, ISM Monopole	W3043 <sup>5</sup>	3.2x1.6x1.1 Ceramic	SMD GC area, 17x20	2400, 1575 and other	N/A	4 (peak)	70/-1.55 (peak)	-12
ISM 868/985 2.4 BT/WiFi	W3320	10x3.2x2.0 Ceramic	SMD GC area, 9.8x8.8	868, 915, 2400	N/A	1.5 (peak) / 3.4 (peak)	66 / - (peak) / 67 / - (peak)	-8 / -6

HELICAL								
Application	Part No.	Size (mm)/ Type	Mount Type <sup>3</sup> (mm)	Frequency Range (MHz)	RHCP Gain (dBic)	Max Gain (dBi)	Efficiency (%/dB)	Return Loss (dB MIN)
WiFi	W3108	5.0x2.5x5.5 Helical	SMD, GC area 7.50x5.50	2400-2483.5	N/A	1.5	50/-3	-8
GPS	W3110	5.0x2.5x5.5 Helical	SMD, GC area 7.50x5.50	1575.42 ±10	-2,1 (peak) / -2,4 (band edges)	1,3 (peak) / 0,7 (band edges)	47/-3,3 (peak) / 43/-3,7 (band edges)	-16
ISM	W3112A	2.5x8.0x8.0 Helical	SMD, GC area 6.00x11.00	902-928	N/A	0.9 (peak) / -0.3 (band edges)	67/-1.7 (peak) / 50/-3 (band edges)	-10
ISM	W3113	12.4x8.0x2.5 Helical	SMD, GC area 8.00x40.00	902-928	N/A	0.8 (peak) / -0.3 (band edges)	66 / -1.8 (peak) / 51/-2.9 (band edges)	-10
ISM (315)	W3126	35.35x9.90 Helical	GC area 8x40	315	N/A	-5	--	-10
ISM (433)	W3127	35.35x9.90 Helical	GC area 8x40	433-435	N/A	-2.9	--	-15

COMPOSITE								
Application	Part No.	Size (mm)/ Type	Mount Type <sup>3</sup> (mm)	Frequency Range (MHz)	RHCP Gain (dBic)	Max Gain (dBi)	Efficiency (%/dB)	Return Loss (dB MIN)
2G/3G	W3544A/B	26x7.65x3 Composite	SMD	824-960/1710-2170	N/A	-1	50%	-6 ave
2G/3G	W3073	10x3.2x4 Composite	SMD	824-894/1710-2170 or 880-960/1710-2170	N/A	2.9	50%	-6 ave
3G / 4G LTE	W3796	40 x 7 x 3	GC area 15 x 40	698 - 2700	N/A	1.5 / 2 / 5.5	55 / 70	-6

1. All antennas are RoHS Compliant  
 2. Operating temperature -40°C to +85°C  
 3. GC = Ground Clearance, mm  
 4. Millimeters (mm)  
 5. Monopole antenna performance is linked to different tuning circuit recommendations for the variety of applications. Consult the data sheet for more information



- Located inside the device.
- Often connected by a short cable assembly to customer PCB.
- Technology: Flexible printed circuit (FPC), PCB, Patch.
- Frequencies: WLAN, Bluetooth, Zigbee, ISM, GPS, 3G/4G LTE, Multi bands.
- Typical applications: Access points, industrial controls, utilities, Internet of Things, M2M, telemedicine, handheld devices, point-of-sale equipment, sensors, lighting, transportation and other devices.

PRINTED CIRCUIT BOARD ANTENNA SOLUTIONS						
Application	Frequency	Part Number	Mechanical Dimensions (in/Mm)	Cable Length (mm) /Connector Type	Gain (dBi)	Efficiency (%)
2G / 3G	850/900/1800/1900	W3501	0.98 x 3.43 x .008 25 x 87 x 0.2	56/ I-PEX Connector	1.5 / 1.5 / 3.5 / 3.5	50 to 55 %
2G / 3G	850/900/1800/1901	W3502	1.69 x 0.67 x 0.02 43 x 17 x 0.5	27.5/ I-PEX Connector	2 / 1 / 1 / 2	40 to 60 %
WiFi	2.4 GHz	W3525Bxxx	0.42 x 1.88 x .031 10.7 x 47.7 x 0.8	Various cable lengths/ I-PEX Connector	2	70%
WiFi	2.4 & 5 GHz	W3513	0.63 x 2.76 x 0.04 16 x 70 x 0.9	250/ I-PEXConnector	2	50 to 72 %
WiFi	2.4 & 5 GHz	W3315B0100	0.23 x 1.8in / 6x45 mm	100, I-PEX, MHF Series	-3.5 / -2.5	70%
3G 4G LTE	698-960 / 1710-2170 / 2300-2700	W3554B0140	120 x 30 x 0.2	143 / I-PEX	2.5	60%
5 GHz Dipole	4900-5850	W3593B0100	45 x 7 x 0.8	109mm / I-PEX	2	50%

ANTENNAS FOR NEAR FIELD COMMUNICATIONS								
Frequency (MHz)*	Part Number	Read Distance (mm)*	Size (mm)	SRF (MHz)**	Inductance (uH)**	Resistance (Ohms)**	Q **	Matched Q ***
13.56	W3579	40	35 x 50 x 0.30	42	1.6	3.6	37.8	5-30
13.56	W7001	40	25 x 25 x 0.12	100	0.9	1.55	49	5-30
13.56	W7002	40	94.6 x 56.8 x 3.65	89	0.65	0.95	57	5-30
13.56	W7013	20	25 x 30 x 0.23	-	-	-	-	-

\* With Matching Network  
 \*\* Coil Without Matching Network  
 \*\*\* With Matching Network (adjustable range)

### ANTENNA INTEGRATION

- Pulse can assist your engineering team to place/fix the antenna in the housing of the device. Antenna position, orientation, and cable routing can all impact the efficiency of the antenna inside the device.
- PCB-based antennas are best placed on flat surfaces for both physical and RF stability with the surrounding structure. Adhesives, slots, or snap-in features can be designed to hold antennas in place.
- FPC-based antennas are provided with adhesive tape for easy assembly in the device.



GPSGB1315 and GPSGP1330  
13 x 13 Active GNSS Module

GPSGB2515 and GPSGP2530  
25 x 25 Active GNSS Module

W5100 Pairmate  
NFC + BT/WiFi

W5101 Pairmate  
NFC + BT/WiFi

### PULSE INTERNAL ACTIVE ANTENNAS FOR GNSS (GPS/ GLONASS/BEIDOU, GALILEO) APPLICATIONS

App.	Type	Pulse Part Number	Operating Frequency (MHz)	RF Performance				ME requirement					
				Antenna Element	LNA (low noise amplifier)			Antenna Dimension (mm)	Overall Dimension (mm)	Connector type	Coaxial Cable (Length; Diameter)		
				VSWR	RHCP Gain (dBic)	Gain (dB)	NF (dB)	Current (mA)	VCC (Vdc)				
GNSS (GPS, Glonass, BeiDou, and Galileo)	Active Module	GPSGB1315	1561 +/- 2.046, 1575.42 +/- 10.23, and 1602.5625 +/- 4 MHz	2:1	-1 ± 1	15 ± 2	< 2.4	< 6	3.3-5.0 +/- 0.5	13x13x5	16x17x8.15	IPEX MHF 20278 or Equiv.	L:100; D:1.13
		GPSGB1330		2:2	-1 ± 1	30 ± 2				13x13x5	16x17x8.15		
		GPSGB2515		2:3	1 ± 1	15 ± 2				25x25x4	30x30x8		
		GPSGB2530		2:4	1 ± 1	30 ± 2				25x25x4	30x30x8		

Note: 1. Further detailed specs such as 'Out of band rejection' of LNA can be found on a datasheet.

### PAIRMATE ANTENNAS

Part Number	Frequency	Impedance	Size mm/inches	SRF	Inductance (uH)	Q Factor	BlueTooth Gain, dBi
W5100	13.56 + 2400 (NFC + BT/WiFi)	50	40x40x1.3 1.57x1.57x0.051	65.9	0.95	44	1.0
W5101	13.56 + 2400 (NFC + BT/WiFi)	50	45x45x1.3 1.77x1.77x0.051	57.6	1.13	46	1.5

PRINTED CIRCUIT BOARD ANTENNA SOLUTIONS - MIMO AND MULTI-BAND

Application	Type	Pulse Part Number	RF Performance				Mechanical Requirements			Note
			Operating Frequency (MHz)	RL Min. (dB)	Peak Gain (dBi Max)	Efficiency, Max %	Antenna DIM. (LxWxH, mm) / Coax Orientation	Cable Length from PCB edge/ Coax Diameter, mm	Connector Type; / Adhesive	
ISM WiFi Combo	FPC	W3312B0100	860-930	-8	2.3	50 (Avg)	75 x 15 Perpendicular	L:100 / D:1.13	U.FL compatible / Adhesive Included	Alternative: W3502, W3538, W3501
ISM WiFi Combo	PCB	W3332B0150	863-928	-5	0.2	55 (Avg)	82 x 15 x 0.56 Perpendicular	L:150 / D:1.13	U.FL compatible / Adhesive Included	ISM 868/915 and 2.4GHz WiFi (two feed cables). Isolation: <-11dB.
			2400-2500	-10	4.1	64 (Avg)	Perpendicular			
	PCB	W3525B039	2400-2483.5	-10	2	65	48 x 11 x 0.8 Perpendicular	L:100 / D:1.13	U.FL compatible / Adhesive Not Incl.	
			4900-5850	-10	2	70	45 x 7 x 0.8 Perpendicular	L:100 / D:1.13	U.FL compatible / Adhesive Not Incl.	
	PCB	W3513B0212	2400-2500	-13	2	70	16 x 70 x 0.9 Parallel	L:212 / D:1.13	U.FL compatible / Adhesive Included	
			4900-5850	-10	2.7	67	Perpendicular			
WiFi, BT, Zigbee	FPC	W3315B0100MHF1	2400-2500	-10	2	75	33 x 7.7 x 0.1 Perpendicular	L: 100 / D:1.13	U.FL compatible / Adhesive Included	W3921BXXXX (for custom cable length)
			4900-5875	-10	5.5	85	45 x 6 x 0.1 Parallel	L:100 / D:1.13	U.FL compatible / Adhesive Included	W3315B0100MHFIII (MHFIII 20367)
	FPC	W3334B0150	2400-2500	-10	4.8	53	14 x 5 x 0.1 Parallel	L:150 / D:1.13	U.FL compatible / Adhesive Included	
			4900-5900	-10	5.5	90	Perpendicular			
MIMO WiFi	FPC	W3917B0050	2400-2500	-10	2.7	62	42.6 x 8.6 x 0.15 Parallel	L:50 / D:1.13	U.FL compatible / Adhesive Included	Parallel cable alignment. See W3917BXXXX (for custom cable length)
			4900-5925	-10	4.9	89	Perpendicular			
	FPC	W3918B0050	2400-2500	-10	3.8	73	35.2 x 8.5 x 0.15 Perpendicular	L:50 / D:1.13	U.FL compatible / Adhesive Included	Perpendicular cable alignment. See W3918BXXXX (for custom cable length)
			4900-5925	-10	5.3	90	Perpendicular			
FPC	W6102B0100	2400-2500	-10	2 (Avg.)	45 (Avg)	50 x 20 x 0.1 Perpendicular	L:100 / D:1.13	U.FL compatible / Adhesive Included	Isolation: -20 dB	
		4900-5900	-10	5 (Avg.)	75 (Avg)	Perpendicular				
FPC	W6103B0100	2400-2500	-10	4.5 (Avg.)	70 (Avg)	80 x 20 x 0.1 Perpendicular	L:100 / D:1.13	U.FL compatible / Adhesive Included	Isolation: -15 dB	
		4900-5900	-10	5 (Avg.)	75 (Avg)	Perpendicular				
3G	PCB	W3502B0020	824-960	-6	2	78	43 x 17 x 0.5 Perpendicular	L:20 / D:1.13	U.FL compatible / Adhesive Included	80mm ground plane with 5mm gap inside plastic box
			1710-1990	-4	2.4	80.0	Perpendicular			
	PCB	W3538B0200	824-960	-6	-	57	40 x 15 x 0.7 Perpendicular	L:200 / D:1.13	U.FL compatible / Adhesive Included	
			1710-2170	-6	-	71	Perpendicular			
4G (LTE)	PCB	W3501B0140	824-960	-7	1.5	61	87 x 25 x 0.2 Perpendicular	L:140 / D:1.13	U.FL compatible / Adhesive Not Incl.	Test unit : 150x100x40. With Adhesive: W3571B0140.
			1710-1990	-8	4.2	71.0	Perpendicular			
	PCB	W3554B0140	698-798	-5	1.5	75	120 x 30 x 0.2 Perpendicular	L:140 / D:1.13	U.FL compatible / Adhesive Included	Connected on a test board 120x120 with 10mm gap
			824-960	-7	1.8	80	Perpendicular			
	FPC	W6112B0100 (2 leads)	1710-2690	-8	3.9	86	Perpendicular			
			698-960	-6	isolation: -10	55 (Avg)	224 x 20 x 0.1 Perpendicular	L:100 / D:1.13	IPEX MHF 20278 or equiv. / Adhesive Included	
MIMO 4G (LTE)	FPC	W6113B0100 (3 leads)	1428-2170	-7.5	isolation: -14	68 (Avg)	224 x 20 x 0.1 Perpendicular	L:100 / D:1.13	IPEX MHF 20278 or equiv. / Adhesive Included	GPS (1575MHZ)
			2300-3600	-10	isolation: -15	65 (Avg)	Perpendicular			



- Radome included - cosmetics may matter.
- Not for outdoor weatherproof environments (not IP67)
- Technology: Dipoles, blades, external patches.
- Cable assemblies or connector options.
- Frequencies: WLAN, 3G/4G LTE, ISM, GPS, Multi-bands.
- Typical applications: Access points, industrial controls, utilities, Internet of Things, M2M, telemedicine, handheld devices, point-of-sale equipment, sensors, lighting, transportation and other devices.

Pulse's new line of wireless access point antennas offers flexible and economical solutions for wireless device OEMs. These antennas offer superior transmission and reception between wireless access points. They are compatible with IEEE 802.11a/b/g/n/ac, Bluetooth, 3G/4G LTE, ZigBee and ISM frequency band applications. All wireless access point antennas are RoHS compliant. For high-volume orders, Pulse can custom design antennas for OEMs. This includes alternative frequencies and a variety of cable and connector options for antenna assemblies.

WIFI (WLAN) ANTENNAS<sup>1,2</sup>

Part Number	Frequency	Max Gain (dBi)	Length (inches/mm)	Application/Standard	Connector
W1063	900 MHz	3.0	6.65 /169	ISM 868 & 915 MHz	RP SNA
W1010 <sup>3</sup>	2.4 GHz	2.0	3.3/83	802.11b/g/n/ac, Bluetooth, ZigBee	SNA Male
W1030	2.4 GHz	2.0	3.25/82.5	802.11b/g/n/ac, Bluetooth, ZigBee	RP SMA
W1037	2.4 GHz	3.2	6.65/169	802.11b/g/n/ac, Bluetooth, ZigBee	RP SNA
W1038	2.4 GHz	4.9	6.65/169	802.11b/g/n/ac, Bluetooth, ZigBee	RP SNA
W1027	2.4 GHz	3.2	4.88/124	802.11b/g/n/ac, Bluetooth, ZigBee	RP SMA
SB24003	2.4 GHz	2.14	2.5/132	802.11b/g/n/ac, Bluetooth, ZigBee	RP SNA
W1043	2.4 & 5.8 GHz	2.0	4.59/117	802.11b/g/n/ac, Bluetooth, ZigBee	RP SNA
W1028B	5.15 & 5.85 GHz	2.0	4.88/124	802.11a/b/g/n/ac, ISM 5.8 GHz	RP SNA

WIFI BROADBAND

Model	Frequency (MHz)	Gain (dBi)	Max Height (in)	VSWR	Connector
SPDA17RP2400/5900	2400-2500	2	6 (Bent)	2.1	RPTNC
	4900-5900	5	7 (Straight)		
SPDA17806/2170LAR	806-960	.5	6 (Bent)	2.5:1	TNC
	1710-2170	.5	7.5 (Straight)		
SPDA24700/2700	698-960	6	7.7 (Bent)	2.5:1	SMA Male
	1710-2170	1.5	9 (Straight)		
	2500-2700	3.4			



SPDA17RP2400/5900



SPDA24700/2700



SPDA17806/2170LAR

SINGLE-BAND EXTERNAL ANTENNAS WITH I-PEX

Part Number	Frequency	Mechanical Length	Cable Length	Photo
W1049B030	2.4GHz	3.25/82.5	3/76	
W1049B050	2.4GHz	3.25/82.5	5/127	
W1049B090	2.4GHz	3.25/82.5	9/229	
W1049B120	2.4GHz	3.25/82.5	12/305	

Pulse offers a wide variety of alternative wireless solutions for applications including machine-to-machine, public safety, hand-held radios, and telematics.

ADDITIONAL 3G/4G LTE, ISM, UHF, VHF, GPS, IP67

Part Number	Frequency (MHz)	Gain (dBi)	Description	Length (in/mm)	Coax	Connector
SPDA24918	863-973	0	Swivel Mount Dipole (E)	8 / 202	N/A	SMA Male
W1900; W1902	824-960/ 1710-1990/ 1920-2170	1 / 2 / 2.5	Penta Rt Angle Stubby (F)	2.1 / 49.5	N/A	SMA Male / RP-SMA Male
W1910; W1911	824-960/ 1710-1990 / 1920-2170	1 / 2 / 2.5	Penta Band Stubby (G)	2 / 49	N/A	SMA Male / RP-SMA Male
W4000G197	1.574 GHz	1.5 dBic / 26dB LNA	GPS Ultra Thin (H)	n/a	200 / 5meter	SMA Male
SPDA17RP2400/5900	2400-2500/4900-5900	1.6/5	Swivel Mount Dipole (J)	7/182	N/A	RPTNC
SB450FME3	450-470	2.14	Stealth Blade (A)	10/254	3' RG-174	FME
SB8003	806-896	2.14	Stealth Blade (A)	2.5/132	3' RG-174	No Conn
SB9003	890-960	2.14	Stealth Blade (A)	2.5/132	3' RG-174	No Conn
SPDA24850/1900	824-894/1850-1990	0/1.2	Swivel Mount Dipole (J)	6.75/171	N/A	SMA
SPDA24700/2700	698-960 / 1710-2710 / 2500-2700	.6/1.5/3.4	LTE Swivel Mount Dipole (J)	9 / 228	N/A	SMA Male
SPWB23150	136-174	-4.5	Wideband (D)	6.75/171	N/A	SMA F T3
SPWH23832	782-882	0	Whip, Standard, ¼ Wave (C)	3/76	N/A	SMA F T3
SPHS24832	800-864	0	Helical, Standard, ¼ Wave (B)	3/76	N/A	SMA F T2
SPDA17806/2170LAR	806-960/1710-2170	.5/5	Pentaband Swivel Mount Dipole (J)	7.5/190.5	N/A	TNC Male
W1920G0915	806-960/1710-2170	1.5	Stealth Blade (A)	4.3/110	3' RG-174	SMA Male
W1920G3658	806-960/1710-2170	1.5	Stealth Blade (A)	4.3/110	9' RG-174	SMA Male



ICE BLADE (IP67) (XXXX)



Now Available: IceBlade Transparent Antennas

- LTE Model with SMA : Pulse part : ICEBLADELS
- LTE Model with TNC : Pulse part : ICEBLADELT
- WiFi Model with SMA : Pulse part : ICEBLADEWS
- WiFi Model with TNC : Pulse part : ICEBLADEWT

See PulseAntennas website for performance data.

STEALTH BLADES

Stealth Blade antennas have the following specifications:

- Gain:** 2.14 dBi
- Maximum Power:** 3 Watts
- Polarization:** Linear

Model	Frequency (MHz)	Bandwidth % @1.5/2.1	Dimensions L x W (in)	Coax	Connector
SB698SMA3	698-960/1710-2170/2300-2700	50/60	4.2 x 1	3' RG-316	SMA
SB698SMA12	698-960/1710-2170/2300-2700	50/60	4.2 x 1	12' RG316	SMA
SB8003	806-896	67/90	5.2 x .75	3' RG-174	No Conn
SB80012	806-896	67/90	5.2 x .75	12' RG-174	No Conn
SB800FME3	806-896	67/90	5.2 x .75	3' RG-174	FME
SB800FME12	806-896	67/90	5.2 x .75	12' RG-174	FME
SB800MPL3	806-896	67/90	5.2 x .75	3' RG-174	MPL
SB800MPL12	806-896	67/90	5.2 x .75	12' RG-174	MPL
SB800SMA3	806-896	67/90	5.2 x .75	3' RG-174	SMA
SB800TNC3	806-896	67/90	5.2 x .75	3' RG-174	TNC
SB800TNC12	806-896	67/90	5.2 x .75	12' RG-174	TNC
SB9003	890-960	67/90	5.2 x .75	3' RG-174	No Conn
SB90012	890-960	55/70	5.2 x .75	12' RG-174	No Conn
SB900SMA3	890-960	55/70	5.2 x .75	3' RG-174	SMA
SB900SMA12	890-960	55/70	5.2 x .75	12' RG-174	SMA
R380.900.323	806-960 / 1710-1990		5 X .8	10' RG-174	FME
R380.900.334	806-960 / 1710-1990		5 X .8	10' RG-174	SMA



MIMO LTE WALL MOUNT ANTENNA

- Frequencies:** 700-960 / 1710-1990 / 2110-2170 / 2500-2700
- Low Band Gain:** 2.5 dBi Average
- High Band Gain:** 3.5 dBi Average
- Pattern:** Omni Directional

Part Number	Cable Type	Antenna Size (inches/mm)	Cable Length (inches/mm)	Connector
WA700/2700SMA	RG - 174	5.85 x 5 x 0.2 / 149 x 127 x 5.1	39.4 / 1000	SMA Male
WA700/2700RPSMA	RG - 174	5.85 x 5 x 0.2 / 149 x 127 x 5.1	39.4 / 1000	Reverse Polarity SMA



WA700



The following chart summarizes performance, size and cost parameters for various antenna types.

ANTENNA PERFORMANCE CHART

Type	Bandwidth	Performance	Length	Connector	Frequency	Pricing
Helical Short	6%	Poor (**)	Short	All	VHF/UHF	\$\$
Helical	8%	Average (***)	Shorter	All	Low/Mid/VHF/UHF	\$\$
Helical Quarter Wave	12%	Good (***)	Longer	All except SMA	VHF	\$\$
Whip	12%	Good (***)	Mid	All	UHF	\$
End Fed Half Wave	10%	Better (****)	Longer	Coaxial	800	\$\$\$
Half Wave Dipole	10%	Best (*****)	Longer	Coaxial	800	\$\$\$\$
Wide Band	25%	Good (***)	Longer	Coaxial	All	\$\$\$\$\$
Dual Band	2x8%	Average (***)	Mid	Coaxial	VHF/UHF	\$\$

Due to the high variability of use, measurements are difficult to make on portable antennas. All Larsen portable antenna designs are tested for gain and VSWR using a standard fixture for portable antennas. Gain measurements are determined based on range or chamber measurements. Performance ratings are determined using a VSWR standard of less than 2.0:1.

KuL DUCKIE® FREQUENCY COLOR CODE

VHF FREQUENCY	COLOR	UHF FREQUENCY	COLOR
136 - 140 MHz	Blue	406 - 420 MHz	Black
142 - 149 MHz	Green	450 - 469 MHz	Black
150 - 160 MHz	Yellow	470 - 512 MHz	Black
162 - 174 MHz	Red	150 / 450 MHz	Blue

Kulduckie®

All factory tuned KuL DUCKIES® are Exactuned to your specified frequency. To order, replace the FREQ, UHF or VHF designation with your desired center frequency.

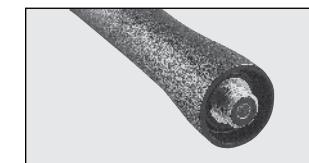

1/4-32X3/16  
Male stud type mount with skirt (MX type) KD2/12

PART NUMBER	ELECTRICAL TYPE	FREQUENCY BAND	APPROX LENGTH
1/4-32x3/16			
KD2FREQHQ1	HQ Helical 1/4 λ	136 - 140 MHz	9 1/2"
KD2FREQHQ2	HQ Helical 1/4 λ	142 - 149 MHz	9 1/2"
KD2FREQHQ3	HQ Helical 1/4 λ	150 - 161 MHz	9 1/2"
KD2FREQHQ4	HQ Helical 1/4 λ	162 - 174 MHz	9 1/2"

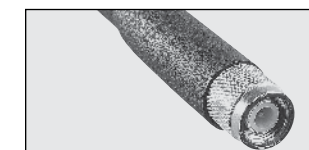

TNC  
TNC Male coaxial connector unskirted (TN type) KD3/13

TNC MALE			
KD3FREQHQ1	HQ Helical 1/4 λ	136 - 140 MHz	9 1/2"
KD3FREQHQ2	HQ Helical 1/4 λ	142 - 149 MHz	9 1/2"
KD3FREQHQ3	HQ Helical 1/4 λ	150 - 161 MHz	9 1/2"
KD3FREQHQ4	HQ Helical 1/4 λ	162 - 174 MHz	9 1/2"
KD3FREQHQ5	HQ Helical 1/4 λ	220 - 222 MHz	9 1/2"
KD13(freq)	1/4 λ	406 - 960 MHz	6"
TNCQ	1/4 λ	136 - 512 MHz	Varies by freq

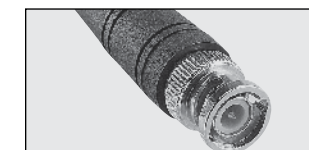

BNC  
BNC Male coaxial connector unskirted KD4/14

BNC MALE			
KD4UHF	Helical 1/4 λ	406 - 512 MHz	3"
KD4VHF1	Helical 1/4 λ	136 - 141 MHz	8"
KD4VHF2	Helical 1/4 λ	142 - 149 MHz	8"
KD4VHF3	Helical 1/4 λ	150 - 161 MHz	8"
KD4VHF4	Helical 1/4 λ	162 - 174 MHz	8"
KD4FREQHQ1	HQ Helical 1/4 λ	136 - 140 MHz	9 1/2"
KD4FREQHQ2	HQ Helical 1/4 λ	142 - 149 MHz	9 1/2"
KD4FREQHQ3	HQ Helical 1/4 λ	150 - 161 MHz	9 1/2"
KD4FREQHQ4	HQ Helical 1/4 λ	162 - 174 MHz	9 1/2"
KD4150T	Helical 1/4 λ	130 - 180 MHz	Varies by freq
KD14(freq)	1/4 λ	406 - 960 MHz	6"
KD14FREQHW1	HW UHF 1/2 λ	315 - 409 MHz	16 1/2"
KD14FREQHW2	HW UHF 1/2 λ	416 - 504 MHz	16 1/2"
BNCQ	1/4 λ	136 - 512 MHz	Varies by freq



- Call us at **+1.800.ANTENNA**
- Visit our website at **pulselarsenantennas.com**
- Connect with us on twitter **PulseLarsen1**

PART NUMBER	ELECTRICAL TYPE	FREQUENCY BAND	APPROX LENGTH
<b>5/16-32X3/8</b>			
KD7FREQHQ1	HQ Helical 1/4 λ	136 - 140 MHz	9 1/2"
KD7FREQHQ2	HQ Helical 1/4 λ	142 - 149 MHz	9 1/2"
KD7FREQHQ3	HQ Helical 1/4 λ	150 - 161 MHz	9 1/2"
KD7FREQHQ4	HQ Helical 1/4 λ	162 - 174 MHz	9 1/2"



5/16-32X3/8

Male stud type mount (KR type) KD7

<b>PL-259</b>			
KD9FREQHQ1	HQ Helical 1/4 λ	136 - 140 MHz	9 1/2"
KD9FREQHQ2	HQ Helical 1/4 λ	142 - 149 MHz	9 1/2"
KD9FREQHQ3	HQ Helical 1/4 λ	150 - 161 MHz	9 1/2"
KD9FREQHQ4	HQ Helical 1/4 λ	162 - 174 MHz	9 1/2"
KD19(freq)	1/4 λ	406 - 512 MHz	6"
PQ	1/4 λ	144 - 512 MHz	Varies by freq



PL-259

Standard UHF Connector Male KD9/19

<b>5/16-24 THDS Female</b>			
KD22VHF1	Helical 1/4 λ	136 - 141 MHz	8"
KD22VHF2	Helical 1/4 λ	142 - 149 MHz	8"
KD22VHF3	Helical 1/4 λ	150 - 161 MHz	8"
KD22VHF4	Helical 1/4 λ	162 - 174 MHz	8"
KD22FREQHQ1	HQ Helical 1/4 λ	136 - 140 MHz	9 1/2"
KD22FREQHQ2	HQ Helical 1/4 λ	142 - 149 MHz	9 1/2"
KD22FREQHQ3	HQ vv 1/4 λ	150 - 161 MHz	9 1/2"
KD22FREQHQ4	HQ Helical 1/4 λ	162 - 174 MHz	9 1/2"

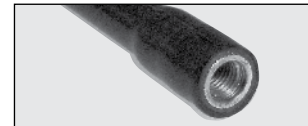

516-24THDS Female

Female threaded KD22

## SPOTS!

### SPOTS! FREQUENCY COLOR CODE (SEE COLOR SPOT ON ANTENNA TOP)

VHF	CENTER FREQUENCY	COLOR
144	138 - 150 MHz	Gray
156	150 - 162 MHz	Orange
160	154 - 166 MHz	Green
167	160 - 174 MHz	Red

UHF	CENTER FREQUENCY	COLOR
420	403 - 437 MHz	Blue
450	432 - 468 MHz	Yellow
470	450 - 490 MHz	Red
490	470 - 510 MHz	Green

800 / 900	CENTER FREQUENCY	COLOR
832	795 - 870 MHz	Blue
918	872 - 964 MHz	Red
1800	1710 - 1850 MHz	Black
1900	1850 - 1990 MHz	Black
2400	2400 - 2500 MHz	Black



### SPOTS! CODE ANTENNA SELECTION GUIDE BY CONNECTOR TYPE

Determine connector type on the following pages and select the proper antenna based on frequency and type below. Field tunable antennas come with a cutting chart and cap to allow for tuning to exact frequency.

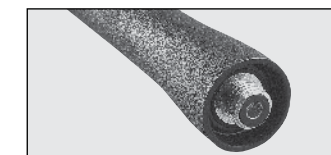

1/4-32X3/16

Male stud type mount with skirt (MX type)

#### Popular Brands Supported

Motorola, Kenwood, Maxon, Midland, Wilson, G.E., Vertex

#### 1/4-32X3/16 - MALE STUD CONNECTOR (MX TYPE)

PART NUMBER	FREQUENCY BAND (MHZ)	ANTENNA TYPE	APPROX LENGTH
SPHL10156	150 - 162	Helical Standard 1/4 λ	8"
SPHS10156	152 - 160	Helical Short 1/4 λ	4"
SPHL10160	154 - 166	Helical Standard - 1/4 λ	8"
SPHL10160IC**	CC to 157	Helical Standard 1/4 λ	8"
SPHL10167	160 - 174	Helical Standard 1/4 λ	8"
SPHL10167IC**	CC to 167	Helical Standard 1/4 λ	8"
SPWH10420	395 - 445	Whip Standard 1/4 λ	6"
SPHS10420	403 - 437	Helical Short 1/4 λ	3"
SPWH10450	425 - 475	Whip Standard 1/4 λ	6"
SPHS10450	432 - 468	Helical Short 1/4 λ	3"
SPWH10470	450 - 490	Whip Standard 1/4 λ	6"
SPHS10470	452 - 488	Helical Short 1/4 λ	3"
SPHL10FT	Field Tunable 136 - 221	Helical Standard 1/4 λ	8"
SPWH10FT	Field Tunable 400 - 512	Whip Standard 1/4 λ	6"

\*\* This antenna is designed with a longer "skirt" for use with ICOM radios.

## SPOTS!

### M7 X 1.00 METRIC CONNECTOR (MD TYPE)

PART NUMBER	FREQUENCY BAND (MHZ)	ANTENNA TYPE	APPROX LENGTH
SPEN14832	806 - 866	Whip - 1/2 λ End Fed	7"
SPWH14832	782 - 882	Whip - Standard - 1/4 λ	3"
SPHS14832	800 - 865	Helical - Short - 1/4 λ	2.75"
SPEN14918	890 - 960	Half λ End Fed	6"
SPHL14FT	Field Tunable 136 - 221	Helical - Standard - 1/4 λ	7"



M7.0X1.0

Male stud type connector unskirted (MD type)

Popular Brands Supported

G.E., Ericsson

### BNC CONNECTOR (BN TYPE)

PART NUMBER	FREQUENCY BAND (MHZ)	ANTENNA TYPE	APPROX LENGTH
SPHS15450	432 - 468	Helical - Short - 1/4 λ	3"
SPHL15FT	Field Tunable 136 - 221	Helical - Standard - 1/4 λ	8"
SPWH15FT	Field Tunable 400 - 512	Whip - Standard - 1/4 λ	6"

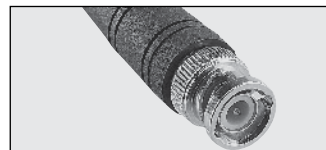

BNC

BNC Male coaxial connector unskirted

Popular Brands Supported

G.E., Kenwood, Motorola, Maxon, Johnson

### BNC CONNECTOR COVERED TYPE (BNX TYPE)

PART NUMBER	FREQUENCY BAND (MHZ)	ANTENNA TYPE	APPROX LENGTH
SPHL16FT	Field Tunable 136 - 221	Helical - Standard - 1/4 λ	8"
SPWH16FT	Field Tunable 400 - 512	Whip - Standard - 1/4 λ	6"

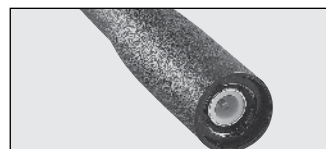

BNC-S

BNC Male coaxial connector fully skirted (BNX type)

Popular Brands Supported

Ericsson

### TNC CONNECTOR - STANDARD (TN TYPE) - EXPOSED BRIGHT FINISH

PART NUMBER	FREQUENCY BAND (MHZ)	ANTENNA TYPE	APPROX LENGTH
SPDA17806/2170LAR	806 - 960 / 1710 - 2170	Center Fed Dipole	8"
SPDA17832	824 - 894	Center Fed Dipole	8"
SPDA17850/1900	824 - 894 / 1850 - 1990	Center Fed Dipole	7.5"
SPDA17918	890 - 960	Center Fed Dipole	8"
SPDA171800	1710 - 1850	Center Fed Dipole	6.5"
SPDA171900	1850 - 1990	Center Fed Dipole	6.5"
SPDA172400	2400 - 2500	Center Fed Dipole	6"
SPDA17RP2400	2400 - 2500	Center Fed Dipole	6"
SPDA17RP2400/5900	2400 - 2500 / 4900 - 5900	Center Fed Dipole	6"
SPDA17RP918	890 - 960	Center Fed Dipole	8"
SPHL17FT	Field Tunable 136 - 221	Helical - Standard - 1/4 λ	8"
SPWH17FT	Field Tunable 400 - 512	Whip - Standard - 1/4 λ	6"
ICEBLADELT	698 - 960 / 1710 - 2170 / 2500 - 2700	Multiband	9"
ICEBLADEWT	698 - 960 / 1710 - 2170 / 2500 - 2700	Multiband	9"

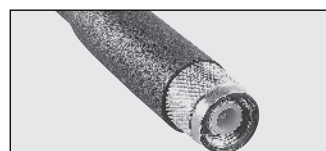

TNC

TNC Male coaxial connector unskirted (TN type)

Popular Brands Supported

Icom, Standard

## SPOTS!

### TNC CONNECTOR - COVERED (TNX TYPE)

PART NUMBER	FREQUENCY BAND (MHZ)	ANTENNA TYPE	APPROX LENGTH
SPHL18FT	Field Tunable 136 - 221	Helical - Standard - 1/4 λ	8"
SPWH18FT	Field Tunable 400 - 512	Whip - Standard - 1/4 λ	6"



TNC-S

TNC Coaxial connector fully skirted (TNX type)

Popular Brands Supported

Vertex

### SMA MALE STANDARD - EXTENDED BASE - T1 (SMS TYPE)

PART NUMBER	FREQUENCY BAND (MHZ)	ANTENNA TYPE	APPROX LENGTH
SPWH20832	782 - 882	Whip - Standard - 1/4 λ	3"
SPHS20832	800 - 864	Helical - Short - 1/4 λ	2.75"
SPWH20918	863 - 973	Whip - Standard - 1/4 λ	3"
SPHS20918	872 - 954	Helical - Short - 1/4 λ	2.75"
SPHL20FT	Field Tunable 136 - 221	Helical - Standard - 1/4 λ	8"
SPWH20FT	Field Tunable 400 - 512	Whip - Standard - 1/4 λ	6"

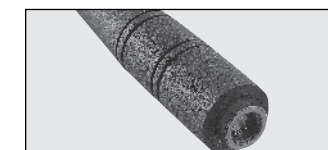

SMA MALE T1

SMA Male extended base (SMS Type)

Popular Brands Supported

Standard

### SMA FEMALE - NON STANDARD MOTOROLA TYPE (SF TYPE)

PART NUMBER	FREQUENCY BAND (MHZ)	ANTENNA TYPE	APPROX LENGTH
SPWB21150	136 - 174	Helical - Standard - 1/4 λ	6.75"
SPHL21156	150 - 162	Helical - Standard - 1/4 λ	8"
SPHS21156	152 - 160	Helical - Short - 1/4 λ	4"
SPHL21167	160 - 174	Helical - Standard - 1/4 λ	8"
SPHS21167	162 - 172	Helical - Short - 1/4 λ	4"
SPWH21450	425 - 475	Whip - Standard - 1/4 λ	6"
SPHS21450	432 - 468	Helical - Short - 1/4 λ	3"
SPHS21490	475 - 512	Helical - Short - 1/4 λ	3"
SPWH21832	782 - 882	Whip - Standard - 1/4 λ	3"
SPHS21832	800 - 864	Helical - Short - 1/4 λ	2.75"
SPWH21918	863 - 973	Whip - Standard - 1/4 λ	3"
SPHS21918	872 - 954	Helical - Short - 1/4 λ	2.75"
SPHL21FT	Field Tunable 136 - 221	Helical - Standard - 1/4 λ	8"
SPWH21FT	Field Tunable 400 - 512	Whip - Standard - 1/4 λ	6"

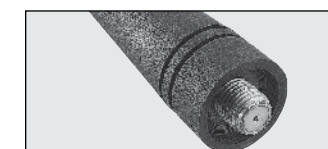

SMA F T1

SMA Female flush insulator & partial skirt (SF Type)

Popular Brands Supported

Motorola

SPOTS!

SMA FEMALE STANDARD - FLUSH BASE - T2 (SFJ TYPE)

PART NUMBER	FREQUENCY BAND (MHZ)	ANTENNA TYPE	APPROX LENGTH
SPWB22150	136 - 174	Helical - Standard - 1/4 λ	6.75"
SPHL22156	150 - 162	Helical - Standard - 1/4 λ	8"
SPHL22167	160 - 174	Helical - Standard - 1/4 λ	8"
SPWH22450	425 - 475	Whip - Standard - 1/4 λ	6"
SPHS22450	432 - 468	Helical - Short - 1/4 λ	3"
SPWH22470	450 - 490	Whip - Standard - 1/4 λ	6"
SPHS22470	452 - 468	Helical - Short - 1/4 λ	3"
SPHS22490	475 - 512	Helical - Short - 1/4 λ	3"
SPWH22832	782 - 882	Whip - Standard - 1/4 λ	3"
SPHS22832	800 - 864	Helical - Short - 1/4 λ	2.75"
SPWH22918	863 - 973	Whip - Standard - 1/4 λ	3"
SPHS22918	872 - 954	Helical - Short - 1/4 λ	2.75"
SPHL22FT	Field Tunable 136 - 221	Helical - Standard - 1/4 λ	8"
SPWH22FT	Field Tunable 400 - 512	Whip - Standard - 1/4 λ	6"

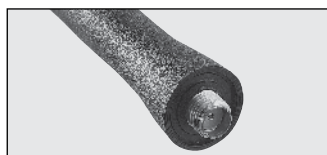

SMA F T2

SMA Female recessed insulator & partial (short) skirt (SFJ type)

Popular Brands Supported

EF Johnson, Kenwood

SMA FEMALE STANDARD - HALF SKIRT BASE - T3 (SFU TYPE)

PART NUMBER	FREQUENCY BAND (MHZ)	ANTENNA TYPE	APPROX LENGTH
SPWB23150	136 - 174	Helical - Standard - 1/4 λ	6.75"
SPHL23167	160 - 174	Helical - Standard - 1/4 λ	8"
SPWH23450	425 - 475	Whip - Standard - 1/4 λ	6"
SPHS23450	432 - 468	Helical - Short - 1/4 λ	3"
SPWH23470	450 - 490	Whip - Standard - 1/4 λ	6"
SPHS23470	452 - 488	Helical - Short - 1/4 λ	3"
SPWH23490	470 - 512	Whip - Standard - 1/4 λ	6"
SPHS23490	475 - 512	Helical - Short - 1/4 λ	3"
SPWH23832	782 - 882	Whip - Standard - 1/4 λ	3"
SPWH23918	863 - 973	Whip - Standard - 1/4 λ	3"
SPHS23918	872 - 954	Helical - Short - 1/4 λ	2.75"
SPHL23FT	Field Tunable 136 - 221	Helical - Standard - 1/4 λ	8"
SPWH23FT	Field Tunable 400 - 512	Whip - Standard - 1/4 λ	6"

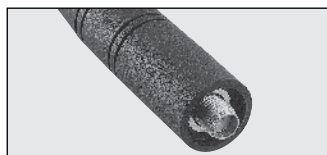

SMA F T3

SMA Female recessed insulator & partial (long) skirt (SFU type)

Popular Brands Supported

Kenwood (2005 and newer models), Uniden, King

SPOTS!

SMA MALE - FLUSH BASE - T2 (SM TYPE)

PART NUMBER	CONNECTOR	FREQUENCY BAND (MHZ)	ANTENNA TYPE	APPROX LENGTH
SPDA24700/2700	SMA Male	698-960/1710-2170/2500-2700	Multiband	9"
SPDA24832	SMA	824 - 894	Center Fed Dipole	9"
SPDA24850/1900	SMA	824 - 894 / 1850 - 1990	Center Fed Dipole	7.5"
SPDA24918	SMA M T2	890 - 960	Center Fed Dipole	8"
SPDA241800	SMA M T2	1710 - 1880	Center Fed Dipole	6.5"
SPDA241900	SMA M T2	1850 - 1990	Center Fed Dipole	6.5"
SPDA242400	SMA	2400 - 2500	Center Fed Dipole	6"
SPDA24RP918	SMA M T2 RP	890 - 960	Center Fed Dipole	8"
SPDA24RP 2400	SMA M T2 RP	2400 - 2500	Center Fed Dipole	6"
SPDP24832	SMA M T2	824 - 894	Center Fed Dipole	8"
SPDP24918	SMA M T2	890 - 960	Center Fed Dipole	
SPDP242400	SMA M T2	2400 - 2500	Center Fed Dipole	3.5"
SPEN24815	SMA M T2	760 - 870	Whip - End Fed - 1/2 λ	7
SPHS24832	SMA M T2	800 - 864	Helical - Short - 1/4 λ	2.75"
SPHS24918	SMA M T2	872 - 954	Helical - Short - 1/4 λ	2.75"
SPWB24150	SMA M T2	136 - 174	Wideband	7.5"
SPWB24425	SMA M T2	380 - 470	Wideband	6.5"
SPWB24480	SMA M T2	440 - 520	Wideband	6"
SPWH24815	SMA M T2	760 - 870	Whip - Short - 1/4 Wave	3.5
SPWH24918	SMA M T2	863 - 973	Whip - Standard - 1/4 λ	3"
SPHL24FT	SMA M T2	Field Tunable 136 - 221	Helical - Standard - 1/4 λ	8"
SPWH24FT	SMA M T2	Field Tunable 400 - 512	Whip - Standard - 1/4 λ	6"
ICEBLADELT	SMA Male	698-960/1710-2170/2500-2700	Multiband	9"
ICEBLADEWS	SMA Male	2400-2500/4900-5900	Multiband	9"



SMA MALE T2

SMA Male flush base (SM Type)

Popular Brands

G.E., Technophone, Relm

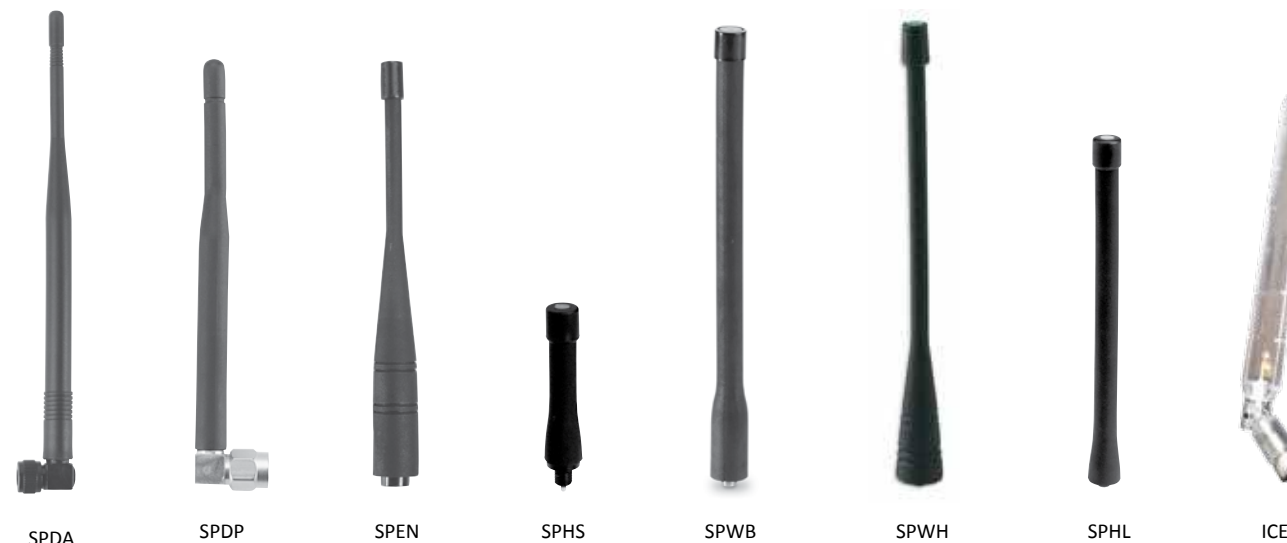

LOW BAND COILS/WHIPS

Model	Type	Frequency (MHz)	Gain (dBi)	Max Height (In)	Power Rating (Watts)	Whip Color	Cable Assembly/Mount
NMO27BCO	Loaded 1/4 λ	27-30		4	150	Coil Only	Order Separately
NMO27B	Loaded 1/4 λ	27-30	2	52.5	150	Black	Order Separately
NMO27C	Loaded 1/4 λ	27-30	2	52.5	150	Stainless	Order Separately
NMO30BCO	Loaded 1/4 λ	30-34		4	150	Coil Only	Order Separately
NMO30B	Loaded 1/4 λ	30-34	2	57.5	150	Black	Order Separately
NMO30C	Loaded 1/4 λ	30-34	2	57.5	150	Stainless	Order Separately
NMO34BCO	Loaded 1/4 λ	34-40		4	150	Coil Only	Order Separately
NMO34B	Loaded 1/4 λ	34-40	2	57.5	150	Black	Order Separately
NMO34C	Loaded 1/4 λ	34-40	2	57.5	150	Stainless	Order Separately
NMO40BCO	Loaded 1/4 λ	40-50		3.5	150	Coil Only	Order Separately
NMO40B	Loaded 1/4 λ	40-50	2	57.5	150	Black	Order Separately
NMO40C	Loaded 1/4 λ	40-50	2	57.5	150	Stainless	Order Separately
NMOWB40C	Loaded 1/4 λ	40-50	2	55	150	Stainless	Order Separately
NMO50BCO	Loaded 1/4 λ	47-54		3.5	150	Coil Only	Order Separately
NMO50B	Loaded 1/4 λ	47-54	2	52.5	150	Black	Order Separately
NMO50C	Loaded 1/4 λ	47-54	2	52.5	150	Stainless	Order Separately
NMOQ52C	1/4 λ	52-88	2	55	150	Stainless	Order Separately
NMOQ88C	1/4 λ	88-136	2	35	150	Stainless	Order Separately
Q52	1/4 λ	52-88	2	55	200	Stainless	Order Separately
Q88	1/4 λ	88-136	2	35	200	Stainless	Order Separately



NMO Low Band



NMOQ Low Band



NMOWB Low Band



Q Series Low Band

The most commonly used cable assembly/mount is the NMOKHFUD (27 MHz to 6 GHz) with 17' of UD (RG-58/U Dual Shield).

NOTE: Larsen springs (SPRING or SPRINGB) can be added to most mobile antennas.



VHF COILS/WHIPS

Model	Type	Frequency (MHz)	Gain (dBi)	Max Height (In)	Power Rating (Watts)	Whip Color	Cable Assembly/Mount	Connector
MHW150BCO	1/2 λ	144-174	2	2.5	200	Coil Only	Order Separately	
MHW150C	1/2 λ	144-174	2	51.5	200	Stainless	Order Separately	
NMO150BCO	5/8 λ	144-174		2.5	200	Coil Only	Order Separately	
NMO150B	5/8 λ	144-174	5.14	51.5	200	Black	Order Separately	
NMO150C	5/8 λ	144-174	5.14	51.5	200	Stainless	Order Separately	
NMO150BK	5/8 λ	144-174	5.14	51.5	200	Black	17' RG-58A/U	PL-259
NMO150CK	5/8 λ	144-174	5.14	51.5	200	Stainless	17' RG-58A/U	PL-259
NMO150HWBCO	5/8 λ	144-174		2.5	200	Coil Only	Order Separately	
NMO150BHW	1/2 λ	144-174	2	51.5	200	Black	Order Separately	
NMO150CHW	1/2 λ	144-174	2	51.5	200	Stainless	Order Separately	
NMOU150D	Loaded 1/4 λ	150-165	2	18	200	Black	Order Separately	
NMOU155D	Loaded 1/4 λ	155-170	2	18	200	Stainless	Order Separately	
NMOWB150BCO	Wideband 1/2 λ	135-174		2.75	100	Coil Only	Order Separately	
NMOWB150B	Wideband 1/2 λ	135-174	2	51.75	100	Black	Order Separately	
NMOWB150C	Wideband 1/2 λ	135-174	2	51.75	100	Stainless	Order Separately	
NMOWB150BK	Wideband 1/2 λ	135-174	2	51.75	100	Black	17' RG-58A/U	PL-259
NMOWBQB	Wideband 1/4 λ	150-170	2	20	200	Black	Order Separately	
NMOWBQC	Wideband 1/4 λ	150-170	2	20	200	Stainless	Order Separately	
NMOQW144	1/4 λ	144-152	2	19	200	Stainless	Order Separately	
NMOQW152	1/4 λ	152-162	2	19	200	Stainless	Order Separately	
LM150BCO	5/8 λ	144-174		2.75	200	Coil Only	Order Separately	
LM150B	5/8 λ	144-174		51.75	200	Black	Order Separately	
LM150C	5/8 λ	144-174		51.75	200	Stainless	Order Separately	
LMWBQ	Wideband 1/4 λ	150-170	2	18.5	200	Stainless	Order Separately	
LMWBQB	Wideband 1/4 λ	150-170	2	18.5	200	Black	Order Separately	
PO150BCO	5/8 λ	144-174	2	2.5	200	Coil Only	Order Separately	
PO150B	5/8 λ	144-174	2	51.5	200	Black	Order Separately	
PO150C	5/8 λ	144-174	2	51.5	200	Black	Order Separately	



MHW

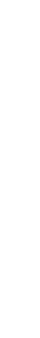

NMO150 / NMOHW



NMOU



NMOWB



NMOWBQ



NMOQW



LMWB



LM



PO

The most commonly used cable assembly/mount is the NMOKHFUD (27 MHz to 6 GHz) with 17' of UD (RG-58/U Dual Shield).

NOTE: Larsen springs (SPRING or SPRINGB) can be added to most mobile antennas.



VHF GLASS MOUNT

Model	Type	Frequency (MHz)	Gain (dBi)	Max Height (In)	Power Rating (Watts)	Whip Color	Cable Assembly/ Mount	Connector
KGFFREQUDPL2	VHF Disguise	140-149	2	20	100	Black	14' RG-58/U	PL-259
KGFFREQUDPL3	VHF Disguise	150-159	2	20	100	Black	14' RG-58/U	PL-259
KGFFREQUDPL4	VHF Disguise	160-170	2	20	100	Black	14' RG-58/U	PL-259
KG144O/S	1/2 λ	144-160	2	48	100	Black	Order Separately	
KG144UD	1/2 λ	144-160	2	48	100	Black	14' RG-58/U	No Conn
KG144UDPL	1/2 λ	144-160	2	48	100	Black	14' RG-58/U	PL-259
KG160O/S	1/2 λ	160-174	2	47	100	Black	Order Separately	
KG160UD	1/2 λ	160-174	2	47	100	Black	14' RG-58/U	No Conn
KG160UDPL	1/2 λ	160-174	2	47	100	Black	14' RG-58/U	PL-259
KGVHFUDI/S	Inside Cable Unit	144-174			100		14' RG-58/U	No Conn



Glass Mount



Low Profile

VHF LOW PROFILE

Model	Frequency (MHz)	Gain (dBi)	Size H x DIA (In)	Power Rating (Watts)	Color	Cable Assembly/ Mount
LP152NMO	151.02-152.98	2	3.75 x 4.5	60	Black	Order Separately
LP154NMO	152.96-155.04	2	3.75 x 4.5	60	Black	Order Separately
LP156NMO	154.42-156.58	2	3.75 x 4.5	60	Black	Order Separately
LP158NMO	156.38-158.62	2	3.75 x 4.5	60	Black	Order Separately
LP160NMO	158.33-160.67	2	3.75 x 4.5	60	Black	Order Separately
LP162NMO	160.29-162.71	2	3.75 x 4.5	60	Black	Order Separately
LP164NMO	162.75-165.25	2	3.75 x 4.5	60	Black	Order Separately
LP167NMO	165.21-167.79	2	3.75 x 4.5	60	Black	Order Separately
LP169NMO	167.68-170.32	2	3.75 x 4.5	60	Black	Order Separately
LP171NMO	170.16-172.84	2	3.75 x 4.5	60	Black	Order Separately
LP174NMO	172.14-174.86	2	3.75 x 4.5	60	Black	Order Separately

The most commonly used cable assembly/mount is the NMOKHFUD (27 MHz to 6 GHz) with 17' of UD (RG-58/U Dual Shield).

VHF DIRECT MOUNTS

Model	Type	Frequency (MHz)	Gain (dBi)	Max Height (In)	Power Rating (Watts)	Whip Color	Cable Assembly	Connector
OM150BCO	1/2 λ	144-174		3	200	Coil Only	17' RB-58A/U	PL-259
OM150CK	1/2 λ	144-174	2	51.75	200	Stainless	17' RB-58A/U	PL-259
PHW150BCO	1/2 λ	144-174	2	2.5	200	Coil Only	Order Separately	
PHW150C	1/2 λ	144-174	2	56.5	200	Stainless	Order Separately	

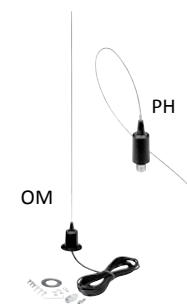

OM



MST

VHF MAGNETIC MOUNTS

Model	Type	Frequency (MHz)	Gain (dBi)	Max Height (In)	Power Rating (Watts)	Whip Color	Cable Assembly	Connector
MSTFME	Tunable 1/4 λ	144-965	2	21	50	Black	12' RG-174	FME Crimp

VHF 220 MHz

Model	Type	Frequency (MHz)	Gain (dBi)	Max Height (In)	Power Rating (Watts)	Whip Color	Cable Assembly/ Mount
NMO220BCO	5/8 λ	220-225	5.2	2.5	200	Coil Only	Order Separately
NMO220B	5/8 λ	220-225	5.2	30	200	Black	Order Separately
NMO220C	5/8 λ	220-225	5.2	30	200	Stainless	Order Separately
NMO220HWBCO	1/2 λ	220-225		3	200	Coil Only	Order Separately
NMO220CHW	1/2 λ	220-225	2	30	200	Stainless	Order Separately



NMOHW

The most commonly used cable assembly/mount is the NMOKHFUD (27 MHz to 6 GHz) with 17' of UD (RG-58/U Dual Shield).

NOTE: Larsen springs (SPRING or SPRINGB) can be added to most mobile antennas.



UHF COILS/WHIPS

Model	Type	Frequency (MHz)	Gain (dBi)	Max Height (In)	Power Rating (Watts)	Whip Color	Cable Assembly
LMUHFBASEB	Base Only	406-512		2	200	Coil Only	Order Separately
LM406C	5/8 over 1/2 λ	406-420	5.6	33	200	Stainless	Order Separately
LM440C	5/8 over 1/2 λ	440-460	5.6	33	200	Stainless	Order Separately
LM450C	5/8 over 1/2 λ	450-470	5.6	33	200	Stainless	Order Separately
NMO4063CS	5/8 λ	406-430	5.14	19	200	Stainless	Order Separately
NMO4303CS	5/8 λ	430-450	5.14	19	200	Stainless	Order Separately
NMO4503CS	5/8 λ	450-470	5.14	19	200	Stainless	Order Separately
NMO4703CS	5/8 λ	470-490	5.14	19	200	Stainless	Order Separately
NMO4903CS	5/8 λ	490-512	5.14	19	200	Stainless	Order Separately
NMO406B	5/8 over 1/2 λ	406-420	5.6	33	200	Black	Order Separately
NMO406C	5/8 over 1/2 λ	406-420	5.6	33	200	Stainless	Order Separately
NMO420B	5/8 over 1/2 λ	420-440	5.6	33	200	Black	Order Separately
NMO420C	5/8 over 1/2 λ	420-440	5.6	33	200	Stainless	Order Separately
NMO440B	5/8 over 1/2 λ	440-460	5.6	33	200	Black	Order Separately
NMO440C	5/8 over 1/2 λ	440-460	5.6	33	200	Stainless	Order Separately
NMO450B	5/8 over 1/2 λ	450-470	5.6	33	200	Black	Order Separately
NMO450C	5/8 over 1/2 λ	450-475	5.6	33	200	Stainless	Order Separately
NMO470C	5/8 over 1/2 λ	470-490	5.6	33	200	Stainless	Order Separately
NMO490B	5/8 over 1/2 λ	490-512	5.6	33	200	Black	Order Separately
NMO490C	5/8 over 1/2 λ	490-512	5.6	33	200	Stainless	Order Separately
NMO406HWBCO	Base Only	406-420		2.5	200	Coil Only	Order Separately
NMO406CHW	1/2 λ Collinear	406-420	5.5	35.5	200	Stainless	Order Separately
NMO420CHW	1/2 λ Collinear	420-440	5.5	35.5	200	Stainless	Order Separately
NMO440CHW	1/2 λ Collinear	440-460	5.5	35.5	200	Stainless	Order Separately
NMO450HWBCO	Base Only	420-512		2.5	200	Coil Only	Order Separately
NMO450CHW	1/2 λ Collinear	450-470	5.5	35.5	200	Stainless	Order Separately
NMOQBASE1B	Base Only	Whip Size .070		2	200	Coil Only	Order Separately
NMOQBASE2B	Base Only	Whip Size .100		2	200	Coil Only	Order Separately
NMOQBASE3B	Base Only	Whip Size .125		2	200	Coil Only	Order Separately
NMOUHBBASEB	Base Only	Whip Size .100		2	200	Coil Only	Order Separately
NMOQW406	1/4 λ	406-430	2	7	200	Stainless	Order Separately
NMOQW450	1/4 λ	450-470	2	7	200	Stainless	Order Separately
NMOWB406BCO	Wide Band Coil	406-512		2.5	200	Coil Only	Order Separately
NMOWB406C	Wide Band	406-430	5.5	35.5	200	Stainless	Order Separately
NMOWB430C	Wide Band	430-455	5.5	35.5	200	Stainless	Order Separately
NMOWB450C	Wide Band	450-475	5.5	35.5	200	Stainless	Order Separately
NMOWB470C	Wide Band	470-495	5.5	35.5	200	Stainless	Order Separately
NMOWB490C	Wide Band	490-515	5.5	35.5	200	Stainless	Order Separately



The most commonly used cable assembly/mount is the NMOKHFUD (27 MHz to 6 GHz) with 17' of UD (RG-58/U Dual Shield).

NOTE: Larsen springs (SPRING or SPRINGB) can be added to most mobile antennas.



UHF GLASS MOUNT

Model	Type	Frequency (MHz)	Gain (dBi)	Max Height (In)	Power Rating (Watts)	Whip Color	Cable Assembly/ Mount	Connector
KG406O/S	1/2 λ	406-420	2	15	100	Black	Order Separately	
KG406UD	1/2 λ	406-420	2	15	100	Black	14' RG-58/U	No Conn
KG406UDPL	1/2 λ	406-420	2	15	100	Black	14' RG-58/U	PL-259
KG420O/S	1/2 λ	420-440	2	15	100	Black	Order Separately	
KG420UDPL	1/2 λ	420-440	2	15	100	Black	14' RG-58/U	PL-259
KG450O/S	1/2 λ	450-470	2	15	100	Black	Order Separately	
KG450UD	1/2 λ	450-470	2	15	100	Black	14' RG-58/U	No Conn
KG450UDPL	1/2 λ	450-470	2	15	100	Black	14' RG-58/U	PL-259
KG470O/S	1/2 λ	470-490	2	15	100	Black	Order Separately	
KG470UD	1/2 λ	470-490	2	15	100	Black	14' RG-58/U	No Conn
KG490O/S	1/2 λ	490-512	2	15	100	Black	Order Separately	
KG490UD	1/2 λ	490-512	2	15	100	Black	14' RG-58/U	No Conn
KGUHFUDI/S	Inside Coupler Only	406-512		100		14' RG-58/U	No Conn	



UHF LOW PROFILE

Model	Frequency (MHz)	Gain (dBi)	Size H x DIA (In)	Power Rating (Watts)	Color	Cable Assembly/ /Mount
LP406NMO	406-420		1.5 x 4.5	100	Black	Order Separately
LP406NMOW	406-420	2	1.5 x 4.5	100	Black	Order Separately
LP420NMO	416-430	2	1.5 x 4.5	100	Black	Order Separately
LP420NMOW	416-430	2	1.5 x 4.5	100	Black	Order Separately
LP450NMO	450-470	2	1.5 x 4.5	100	Black	Order Separately
LP450NMOW	450-470	2	1.5 x 4.5	100	Black	Order Separately
LP470NMO	470-490	2	1.5 x 4.5	100	Black	Order Separately
LP470NMOW	470-490	2	1.5 x 4.5	100	Black	Order Separately
LP490NMO	490-512	2	1.5 x 4.5	100	Black	Order Separately
LP490NMOW	490-512	2	1.5 x 4.5	100	Black	Order Separately
LPT450NMO	450-470	2	4.5 x 1.5	100	Black	Order Separately
LPT450/512NMO	450-520	4.6	3.5x1.5	100	Black	Order Separately



The most commonly used cable assembly/mount is the NMOKHFUD (27 MHz to 6 GHz) with 17' of UD (RG-58/U Dual Shield).

UHF DIRECT MOUNTS

Model	Type	Frequency (MHz)	Gain (dBi)	Size (In)	Power Rating (Watts)	Whip Color	Cable Assembly	Connector
LP450	Low Profile	450-470	2	1.25H x 5.25D	100	N/A	17' RG-58/U	No Conn
OM406BCO	1/2 λ	406-440		4	100	Coil Only	17' RG-58A/U	PL259
OM450BCO	1/2 λ	440-512		4	100	Coil Only	17' RG-58A/U	PL259
OM406CK	1/2 λ Collinear	406-420	5.5	35.5	100	Stainless	17' RG-58A/U	PL259
OM420CK	1/2 λ Collinear	420-440	5.5	35.5	100	Stainless	17' RG-58A/U	PL259
OM450CK	1/2 λ Collinear	450-470	5.5	35.5	100	Stainless	17' RG-58A/U	PL259
OM470CK	1/2 λ Collinear	470-490	5.5	35.5	100	Stainless	17' RG-58A/U	PL259

LP Direct Mount



OM

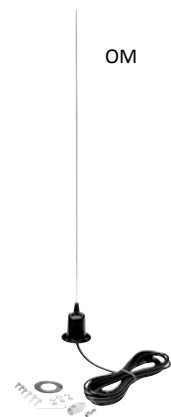

UHF MAGNETIC MOUNTS

Model	Type	Frequency (MHz)	Gain (dBi)	Max Height (In)	Power Rating (Watts)	Whip Color	Cable Assembly	Connector
MSTFME	Tunable 1/4 λ	144-965	2	21	50	Black	12' RG-174	FME Crimp
MSTBNCFT	Tunable 1/4 λ	144-965	2	21	50	Black	12' RG-174	TNC

MST



UHF STEALTH BLADES

Stealth Blade antennas have a gain of 2.14 dBi, a maximum power of 3 Watts and linear polarization.

Model	Frequency (MHz)	Bandwidth % @1.5/2.1	Dimensions L x W (In)	Coax	Connector
SB450FME12	450-470	20/30	10" x 0.75"	12' RG-316	FME

SB

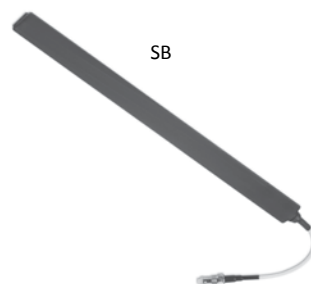

MULTI BAND COILS/WHIPS

Model	Type	Frequency (MHz)	Gain (dBi)	Max Height (In)	Power Rating (Watts)	Whip Color	Cable Assembly
NMO2/70BCO	Dual Band Coil	144-148 / 440-450			100	Coil Only	Order Separately
NMO2/70B	VHF: Center Loaded 1/2 λ	144-148	3.8	34.5	100	Black	Order Separately
	UHF: Collinear	440-450	5.2				
NMO2/70SH	VHF: Center Loaded 1/2 λ	144-148	2.14	19	200	Stainless	Order Separately
	UHF: Center Loaded 3/4 λ	440-450	4				
NMO150/450C	VHF: Center Loaded 1/2 λ	150-154	3.8	37.25	100	Stainless	Order Separately
	UHF: Collinear	450-460	5.2				
NMO150/450/800	Tri Band	150-165 / 450-470 / 806-940	2.14	16.5	100	Black	Order Separately

NMO2/70



NMO2/70SH



NMO150/450C



NMO150/450/800



MULTI BAND VHF/UHF GLASS MOUNT

Model	Type	Frequency (MHz)	Gain (dBi)	Max Height (In)	Power Rating (Watts)	Whip Color	Cable Assembly	Connector
KG2/70CXPL	1/2 λ Collinear	144-148 / 442-448	2	32.75	100	Black	14' RG-58A/U	PL-259
KG2/70CXFME	1/2 λ Collinear	144-148 / 442-448	2	32.75	100	Black	14' RG-58A/U	FME

KG2/70

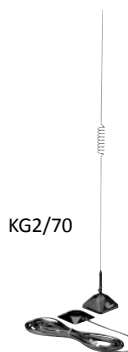

MULTI BAND VHF/UHF MAGNETIC MOUNTS

Model	Type	Frequency (MHz)	Gain (dBi)	Max Height (In)	Power Rating (Watts)	Whip Color	Cable Assembly	Connector
MM2/70PL	VHF: Center Loaded 1/4 λ	144-148	2	21	50	Black	12' RG-58A/U	PL-259
	UHF: Center Loaded 3/4 λ	442-448	4					

MM2/70



The most commonly used cable assembly/mount is the NMOKHFUD (27 MHz to 6 GHz) with 17' of UD (RG-58/U Dual Shield).



TUNABLE 1/4 WAVE COILS/WHIPS

Model	Frequency (MHz)	Gain (dBi)	Max Height (In)	Power Rating (Watts)	Whip Color	Cable Assembly
NMOQSPEC	136-960	2	22	200	Stainless	Order Separately
NMOQSPECB	136-960	2	22	200	Black	Order Separately
NMOQC	136-512	2	23	200	Stainless	Order Separately
NMOQB	136-512	2	23	200	Black	Order Separately
PQ	136-512	2	22	200	Stainless	Order Separately
Q	136-512	2	22	200	Stainless	Order Separately
QB	136-512	2	22	200	Black	Order Separately



TUNABLE 1/4 WAVE MAGNETIC MOUNTS

Model	Frequency (MHz)	Gain (dBi)	Max Height (In)	Power Rating (Watts)	Whip Color	Cable Assembly	Connector
MSTFME	144-965	2	21	50	Black	12' RG-174	FME Crimp

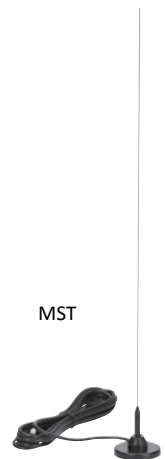

700/800/900/1850 MHz COILS/WHIPS

Model	Type	Frequency (MHz)	Gain (dBi)	Max Height (In)	Power Rating (Watts)	Whip Color	Cable Assembly and Connector
LM800	5/8 over 1/2 λ	806-866	5.6	14.5	200	Stainless	Order Separately
LM825	5/8 over 1/2 λ	824-896	5.6	14.5	200	Stainless	Order Separately
LM900	5/8 over 1/2 λ	890-960	5.6	14.5	200	Stainless	Order Separately
NMOQW700	1/4 λ	740-806	2	3	200	Stainless	Order Separately
NMOQW800	1/4 λ	806-896	2	3	200	Stainless	Order Separately
NMOQW900	1/4 λ	890-970	2	3	200	Stainless	Order Separately
NMOQSPEC800B	1/4 λ	806-896	2	4	200	Black	Order Separately
NMOQSPEC900B	1/4 λ	890-970	2	4	200	Black	Order Separately
NMOQ700B	1/4 λ	740-806	2	4.5	200	Black	Order Separately
NMOQ800B	1/4 λ	806-896	2	4.5	200	Black	Order Separately
NMOQ900B	1/4 λ	890-960	2	4.5	200	Black	Order Separately
NMOSPEC800	5/8 over 1/4 λ	806-866	5.4	13.5	200	Stainless	Order Separately
NMOSPEC825	5/8 over 1/4 λ	824-896	5.4	13.5	200	Stainless	Order Separately
NMOSPEC900	5/8 over 1/4 λ	890-960	5.4	13.5	200	Stainless	Order Separately
NMO3HD800B	5/8 over 1/4 λ	806-866	5.4	13.75	200	Black	Order Separately
NMO3HD825B	5/8 over 1/4 λ	824-896	5.4	13.75	200	Black	Order Separately
NMO3HD900B	5/8 over 1/4 λ	890-960	5.4	13.75	200	Black	Order Separately
NMO3E700B	5/8 over 1/4 λ	740-806	5.4	13.5	200	Black	Order Separately
NMO3E800B	5/8 over 1/4 λ	806-866	5.4	13.5	200	Black	Order Separately
NMO3E825B	5/8 over 1/4 λ	824-896	5.4	13.5	200	Black	Order Separately
NMO3E900B	5/8 over 1/4 λ	890-960	5.4	13.5	200	Black	Order Separately
NMO700	5/8 over 1/2 λ	740-806	5.6	12.75	200	Stainless	Order Separately
NMO800	5/8 over 1/2 λ	806-866	5.6	12.75	200	Stainless	Order Separately
NMO825	5/8 over 1/2 λ	824-896	5.6	12.75	200	Stainless	Order Separately
NMO900	5/8 over 1/2 λ	890-960	5.6	12.75	200	Stainless	Order Separately
NMO800B	5/8 over 1/2 λ	806-866	5.6	12.75	200	Black	Order Separately
NMO825B	5/8 over 1/2 λ	824-896	5.6	12.75	200	Black	Order Separately
NMO900B	5/8 over 1/2 λ	890-960	5.6	12.75	200	Black	Order Separately
NMO5T800B	5/8 over 5/8 over 1/4 λ	806-866	7.2	18	200	Black	Order Separately
NMO5T825B	5/8 over 5/8 over 1/4 λ	824-896	7.2	18	200	Black	Order Separately
NMO5T900B	5/8 over 5/8 over 1/4 λ	890-960	7.2	18	200	Black	Order Separately
NMO5E825B	5/8 over 5/8 over 1/4 λ	824-896	7.2	19	200	Black	Order Separately
NMO5E900B	5/8 over 5/8 over 1/4 λ	890-960	7.2	19	200	Black	Order Separately
Q800	1/4 λ	806-866	2	3.5	200	Stainless	Order Separately
Q900	1/4 λ	890-960	2	3.5	200	Stainless	Order Separately



The most commonly used cable assembly/mount is the NMOKHFUD (27 MHz to 6 GHz) with 17' of UD (RG-58/U Dual Shield).

The most commonly used cable assembly/mount is the NMOKHFUD (27 MHz to 6 GHz) with 17' of UD (RG-58/U Dual Shield).

700/800/900/1850 MHz COILS/WHIPS (CONTINUED)

Model	Type	Frequency (MHz)	Gain (dBi)	Max Height (in)	Power Rating (Watts)	Whip Color	Cable Assembly	Conn
NMOC/P3E	5/8 over 1/4 λ	824-960 1850-1990	4	4.7	10	Black	Order Separately	
NMOC/P3EUD	5/8 over 1/4 λ	824-960 1850-1990	4	4.7	10	Black	17' RG-58/U	No Conn
NMOC/P3EUDFME	5/8 over 1/4 λ	824-960 1850-1990	4	4.7	10	Black	17' RG-58/U	FME
NMOC/P3EUDMPL	5/8 over 1/4 λ	824-960 1850-1990	4	4.7	10	Black	17' RG-58/U	MPL
NMOC/P3EUDSMA	5/8 over 1/4 λ	824-960 1850-1990	4	4.7	10	Black	17' RG-58/U	SMA
NMOC/P3EUDTNC	5/8 over 1/4 λ	824-960 1850-1990	4	4.7	10	Black	17' RG-58/U	TNC



NMOC/P3E



KG3E



KGI

700/800/900/1850 MHz GLASS MOUNT

Optimum glass thickness 0.138" through 0.158"

Model	Type	Frequency (MHz)	Gain (dBi)	Height (in)	Rating (Watts)	Whip Color	Cable Assembly	Connector
KGI768	1/4 λ	768-896	2	-	60	Black	14' RG-58/U	No Conn
KG3E770	5/8 over 1/2 λ	764-869	-	-	60	Black	14' RG-58/U	No Conn
KG3E825UD	5/8 over 1/2 λ	806-896	5.14	13	60	Black	14' RG-58/U	No Conn
KG3E825UDFME	5/8 over 1/2 λ	806-896	5.14	13	60	Black	14' RG-58/U	FME
KG3E825UDMPL	5/8 over 1/2 λ	806-896	5.14	13	60	Black	14' RG-58/U	MPL
KG3E825UDTNC	5/8 over 1/2 λ	806-896	5.14	13	60	Black	14' RG-58/U	TNC
KG3E900UD	5/8 over 1/2 λ	890-960	5.14	13	60	Black	14' RG-58/U	No Conn
KG3E900UDFME	5/8 over 1/2 λ	890-960	5.14	13	60	Black	14' RG-58/U	FME
KG3E900UDMPL	5/8 over 1/2 λ	890-960	5.14	13	60	Black	14' RG-58/U	MPL
KG3E825O/S	5/8 over 1/2 λ	806-896	5.14	13	60	Black	Outside Coupler Only	
KG3E900O/S	5/8 over 1/2 λ	890-960	5.14	13	60	Black	Outside Coupler Only	
KGI825	1/4 λ Dipole	806-896	2	-	60	Black	14' RG-58/U	No Conn
KGC/P3EUD	Cellular: Collinear PCS: 5/8 over 5/8 over 1/2 λ	824-896 1850-1990	5.14 5.14	13	7	Black	15' RB-58/U	No Conn
KGC/P3EUDFME	Cellular: Collinear PCS: 5/8 over 5/8 over 1/2 λ	824-896 1850-1990	5.14 5.14	13	7	Black	15' RB-58/U	FME

700/800/900/1850 MHz NMO MOUNT LOW PROFILE

Model	Frequency (MHz)	Gain (dBi)	Size H x DIA (in)	Power Rating (Watts)	Color	Cable Assembly
LP78NMO	740-960	4	1.5 x 4.5	100	Black	Order Separately
LP800NMO	806-960	2	1.5 x 4.5	100	Black	Order Separately
LP800NMOW	806-960	2	1.5 x 4.5	100	White	Order Separately
LPT700/800NMO	740-866	2	3.25 x 1.5	100	Black	Order Separately
LPT800/900NMO	806-960	2	3.25 x 1.5	100	Black	Order Separately
LPT825/19NMOHF	806-960 1710-2170 2400	3 3 4	3 x 1.75	45	Black	Order Separately Requires NMOHF Mount
SLPT698/960NMO	698-960	4.5	3 x 1.5	45	Black	Order Separately
SLPT698/2170NMOHF	698-960 1710-2170 2400-2700	4.5 5.6 4	3 x 1.75	45	Black	Order Separately Requires NMOHF Mount
ICEFINLNMOHF	698-2700	3	3 x 1.5	30	Transparent	Order Separately
ICEFIN698960NMO	698-960	3	3 x 1.5	30	Transparent	Order Separately
ICEFIN806NMO	698-960	2.9	3 x 1.5	35	Transparent	Order Separately

ICEFIN698-960NMO



LP



LPT



SLPT NMO



700/800/900/1850 MHz DIRECT MOUNTS

Model	Type	Frequency (MHz)	Gain (dBi)	Size (in)	Power Rating (Watts)	Color	Cable Assembly	Connector
LP800	Low Profile	806-960	2	1.25H x 5.25D	100	Black	17' RG-58/U	No Conn
LPT698/2700DMN		698-960 1710-2170 2300-2700	3.1 4.4 5	1.6 x 4.2		Black	Order Separately	N Female
OM800UD	5/8 over 1/2 λ	806-866	3.2	15.5 H	60	Black	14' RG-58/U	No Conn
OM800UDMPL	5/8 over 1/2 λ	806-866	3.2	15.5 H	60	Black	14' RG-58/U	MPL
OM800UDTNC	5/8 over 1/2 λ	806-866	3.2	15.5 H	60	Black	14' RG-58/U	TNC
OM825UD	5/8 over 1/2 λ	824-896	3.2	15.5 H	60	Black	14' RG-58/U	No Conn
OM825UDMPL	5/8 over 1/2 λ	824-896	3.2	15.5 H	60	Black	14' RG-58/U	MPL
OM825UDTNC	5/8 over 1/2 λ	824-896	3.2	15.5 H	60	Black	14' RG-58/U	TNC
OM900UD	5/8 over 1/2 λ	890-960	3.2	15.5 H	60	Black	14' RG-58/U	No Conn
SLPT698/869DMN	Low Profile	698-869	4.5	3 x 1.5	45	Black	Order Separately	N Female
SLPT806DMN	Low Profile	806-960	4.5	3 x 1.5	45	Black	Order Separately	N Female
SLPT698/2170DMN	Low Profile	Cellular: 698-960 PCS: 1710-2170 ISM: 2400-2700	4.5 5.6 4	3 x 1.75	45	Black	Order Separately	N Female
ICEFIN698/869DMN	ICEFIN	698-869	2.6	3 x 1.5	15	Transparent	Order Separately	N Female
ICEFIN698/960NMO	ICEFIN	806 - 960	3.7	3 x 1.5	20	Transparent	Order Separately	N Female

ICEFIN806DMN



OM



SLPT DM



LP Direct Mount



LPT



The most commonly used cable assembly/mount is the NMOKHFUD (27 MHz to 6 GHz) with 17' of UD (RG-58/U Dual Shield).

700/800/900/1850 MHz MAGNETIC MOUNTS

Model	Type	Frequency (MHz)	Gain (dBi)	Max Height (In)	Power Rating (Watts)	Whip Color	Cable Assembly	Connector
MS3E800FME	5/8 over 1/2 λ	806-896	5.6	13	60	Black	12' RG-58A/U	FME
MS3E800MPL	5/8 over 1/2 λ	806-896	5.6	13	60	Black	12' RG-58A/U	MPL
MS3E800TNC	5/8 over 1/2 λ	806-896	5.6	13	60	Black	12' RG-58A/U	TNC
MS3E900MPL	5/8 over 1/2 λ	890-960	5.6	13	60	Black	12' RG-58A/U	MPL
MS3E900TNC	5/8 over 1/2 λ	890-960	5.6	13	60	Black	12' RG-58A/U	TNC
MS3E900SMA	5/8 over 1/2 λ	890-960	5.6	13	40	Black	12' RG-58A/U	SMA
MM5E900BNC	5/8 over 5/8 over 1/4 λ	890-960	7.12	16.5	60	Black	12' RG-58A/U	BNC
MM5T900SMA	5/8 over 5/8 over 1/4 λ	890-960	7.2	18	60	Black	12' RG-58A/U	SMA
MM5T900SMARP	5/8 over 5/8 over 1/4 λ	890-960	7.2	18	60	Black	12' RG-58A/U	SMA RP
MSU800FME	1/2 λ	806-896	2	4	40	Black	12' RG-58A/U	FME
MSU900FME	1/2 λ	890-960	2	4	40	Black	12' RG-58A/U	FME
MMC/P3EFME	5/8 over 1/4 λ	824-960 1850-1990	4 4	5	7	Black	12' RG-58/U	FME
MMC/P3EMPL	5/8 over 1/4 λ	824-960 1850-1990	4 4	5	7	Black	12' RG-58/U	MPL
MMC/P3ETNC	5/8 over 1/4 λ	824-960 1850-1990	4 4	5	7	Black	12' RG-58/U	TNC
MMC/P3ESMA	5/8 over 1/4 λ	824-960 1850-1990	4 4	5	7	Black	12' RG-58/U	SMA

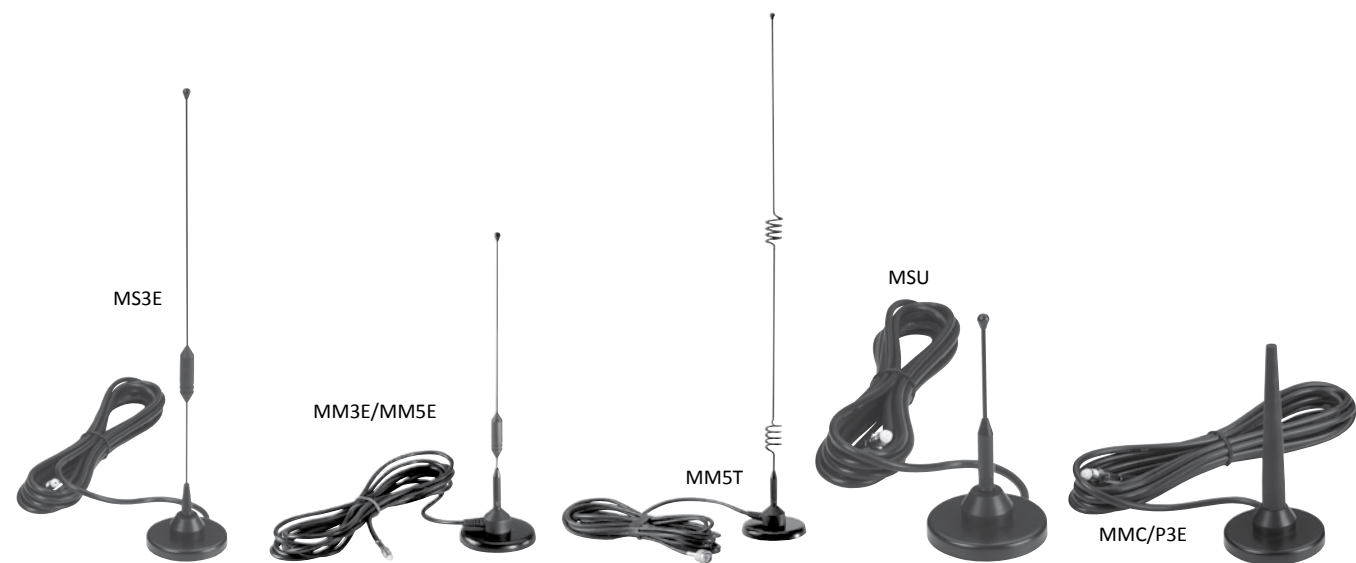

GPS DIRECT MOUNTS

GPS single band direct mount antennas have the following specifications:

**Frequency:** 1575.4  
**Gain:** 5 dBic  
**LNA Gain:** 28 dB ± 2 dB  
**Pattern:** Hemispherical  
**Mounting:** Direct Feed 5/8" hole

**Polarization:** Right-Hand Circular  
**Coax:** 17' RG-174  
**Voltage:** 5 V DC  
**Color:** Black  
**Size:** .7" H x 2.5" Dia



Model	Connector	Color
GPSDM02	MCX	Black
GPSDM04	MMCX	Black
GPSDM06	SMB	Black
GPSDM08	SMA	Black

Contact factory for upcoming GNSS models covering GPS, Glonass, Beidou/Compass and Galileo.

GPS COMBI WHIP DIRECT MOUNTS

GPS combi whip direct mount antennas have the following specifications:

**LNA Gain:** 26 dB ± 2 dB  
**Polarization:** Right-Hand Circular /Vertical  
**Mounting:** Direct Feed 5/8" hole  
**Color:** Black

**Pattern:** Hemispherical / Omni  
**Coax:** 16.4' RG-174 / 16.4' RG-174  
**Voltage:** 5 V DC  
**Base Size:** 2" W x 2.3" L x 0.7" H



Model	Frequency (MHz)	Gain (dBi/dBic)	Whip Length (In)	Connector
GPSCW1502	136-174 / 1575.42	2.14/5	22	SMA/SMB
GPSCW4501	406-512 / 1575.42	2.14/5	6.25	SMA/SMA
GPSCW4502	406-512 / 1575.42	2.14/5	6.25	SMA/SMB
GPSCW3E8001	806-896 / 1575.42	5/5	11.5	SMA/SMA
GPSCW3E8003	806-896 / 1575.42	5/5	11.5	FME/SMA

GPS DIRECT MOUNT

GPS single band direct mount antennas have the following specifications:

**Frequency:** 1575.4  
**Gain:** 4 dBic  
**LNA Gain:** 25 dB ± 2 dB  
**Pattern:** Hemispherical  
**Mounting:** Direct Feed 5/8" hole

**Polarization:** Right-Hand Circular  
**Coax:** LMR-195  
**Voltage:** 3V-5V DC  
**Color:** GRAY (PANTONE 427)  
**Size:** .87" H x 1.97" Dia



Model	Cable Length	Connector
GPSDM26B0500	19.68" (500mm)	SMA

Contact factory for upcoming GNSS models covering GPS, Glonass, Beidou/Compass and Galileo.

GLASS MOUNT

GPS glass mount single band antennas have the following specifications:

**Frequency:** 1575.4 MHz      **Gain:** 1.5 dBi  
**Pattern:** Hemispherical      **LNA Gain:** 26 dB ± 2 dB  
**Polarization:** Right-Hand Circular      **VSWR:** 1.5:1  
**Mounting:** Double Sided Tape      **Voltage:** 3V or 5V DC

Model	Size H x L x W (In)	Color	Cable	Connector
GPSGMSMA	.2 x 3 x 1.2	Black	16.4' RG-174	SMA
GPSGMSMB	.2 x 3 x 1.2	Black	16.4' RG-174	SMB



GPSGM

GPS LOW PROFILE SINGLE BAND

GPS low profile single band antennas have the following specifications:

**Frequency:** 1575.4 MHz      **Gain:** 5 dBi  
**Pattern:** Hemispherical      **LNA Gain:** 28 dB ± 2 dB  
**Polarization:** Right-Hand Circular      **VSWR:** 2.0:1  
**Mounting:** NMO Mount      **Voltage:** 5V DC

Model	Size H x D (In)	Color	Cable	Connector
GPSNMO01	1.3 x 2.9	White	Order Separately	Order Separately
GPSNMO02	1.3 x 2.9	Black	Order Separately	Order Separately
GPSNMO07	1.3 x 2.9	White	17' RG-58/U	SMB
GPSNMO08	1.3 x 2.9	Black	17' RG-58/U	SMB
GPSNMO09	1.3 x 2.9	White	17' RG-58/U	SMA
GPSNMO10	1.3 x 2.9	Black	17' RG-58/U	SMA



GPS LOW PROFILE



GPS0015

GPS TIMING ANTENNA

Model	Frequency (MHz)	LNA Gain (± 2 dB)	Dimensions H x W (In)	Polarization	Voltage	Color	Mounting	Connector
GPS0015	1575.42 ± 1.023	25	4 x 4.5	RHCP	4V-15V DC	White	Bracket	N Male

GPS LTE DIRECT MOUNTS

Model	Frequency (MHz)	Gain (dBi)	Polarization	VSWR	Mounting	Voltage	Size H x Dia (In)	Cable	Conn
GPSDM700/2500FFS	698-960/1710-2170/2300-2700	3	Linear Vertical	2.0:1	3/4" Hole	3 or 5	3.5 x 4.16	17' RG-58	FME
	2400-2485/5150-5850	6	Linear Vertical					17' RG-58	FME
	1575.42	5 dBic	RHCP					17' RG-174	SMA

MODEL	LTE		WIFI		GPS	
	CABLE	CONN.	CABLE	CONN.	CABLE	CONN.
GPSDM700/5800SSS	17' RG-58	SMA	17' RG-58	SMA	17' RG-174	SMA
GPSDM700/5800GGT	17' RG-58	SMA	17' RG-58	RP-SMA	17' RG-174	SMA
GPSDMW700/5800SSS	17' RG-58	SMA	17' RG-58	SMA	17' RG-174	SMA

GPS & CELLULAR COMBO DIRECT MOUNT

Direct mount antennas have the following specifications:

**Frequency:** 824-960 / 1710-2170 / 1575.4 MHz  
**VSWR:** <2.0:1  
**Gain:** 2 dBi / 2 dBi / 5 dBi  
**LNA Gain:** 26 dB ± 2 dB  
**Pattern:** Omni / Omni / Hemispherical  
**Voltage:** 3V or 5V DC  
**Polarization:** Vertical / Vertical / Right-Hand Circular  
**Coax:** 16.4' RG-174 / 16.4' RG-174  
**Mounting:** Direct Feed 3/4" hole

Model	Size L x W x D (In)		Color	Connector
	L	W x D		
GPSCP00	7.6	3.4 x 1.3	Black	TNC/SMA
GPSCP01	7.6	3.4 x 1.3	White	No Conn
GPSCP02	7.6	3.4 x 1.3	Black	No Conn/SMA
GPSCP03	7.6	3.4 x 1.3	White	No Conn/SMA
GPSCP04	7.6	3.4 x 1.3	Black	No Conn/SMB
GPSCP05	7.6	3.4 x 1.3	White	No Conn/SMB
GPSCP06	7.6	3.4 x 1.3	Black	SMA/SMA
GPSCO07	7.6	3.4 x 1.3	White	SMA/SMA
GPSCP08	7.6	3.4 x 1.3	Black	MPL/SMA
GPSCP09	7.6	3.4 x 1.3	White	MPL/SMA
GPSCP10	7.6	3.4 x 1.3	Black	TNC/BNC
GPSCWCP00	3.9	2.3 x 3.2	Black	TNC/SMA
GPSCWCP01	3.9	2.3 x 3.2	Black	No Conn/SMA
GPSCWCP02	3.9	2.3 x 3.2	Black	No Conn/SMB
GPSCWCP03	3.9	2.3 x 3.2	Black	SMA/MPL
GPSCWCP04	3.9	2.3 x 3.2	Black	SMA/SMA
GPSCWCP05	3.9	2.3 x 3.2	Black	TNC/TNC



GPSDM700/2500FFS

GPSDM700/5800SSS

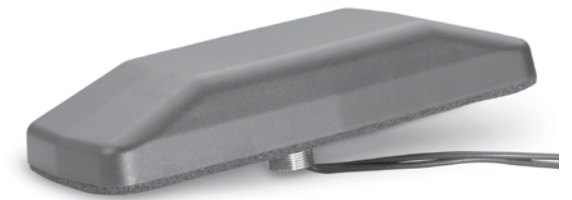

GPSCP



GPSCW



GPS DIRECT MOUNT

NMOHFGPS mount have the following specifications:

**Frequency:** 1575.4 - 1576.4 MHz  
**Polarization:** Right-Hand Circular / Vertical  
**Cable:** 16.4' RG-174 (GPS)  
 16.4' RG-58 (NMOHF)  
**Size:** .5 x 2 x 4.5  
**Mounting:** 5/8" Hole

**Gain:** 5 dBic  
**LNA Gain:** 26 dB ± 2 dB  
**VSWR:** Less than 2:1  
**Voltage:** 3V or 5V DC  
**Color:** Black

Model	Connectors (mount / GPS)	Color
NMOHFGPSFMENOCNN	FME/No Connector	Black
NMOHFGPSFMESMA	FME/SMA	Black
NMOHFGPSNOCNN	No Connectors	Black
NMOHFGPSSMASMA	SMA/SMA	Black

NOTE: Specifications listed refer to GPS performance. Additional antenna specifications are dependent on the antenna mounted on the NMO side.

GPS MAGNETIC MOUNT

GPS single band magnetic mount antennas have the following specifications:

**Frequency:** 1575.4 MHz  
**Pattern:** Hemispherical  
**Polarization:** Right-Hand Circular  
**Cable:** 17' RG-174

**Gain:** 5 dBic  
**LNA Gain:** 26 dB ± 2 dB  
**VSWR:** Less than 2:1  
**Voltage:** 5V DC

Model	Size H x L x W (in)	Color	Connector
GPS0002	0.5 x 1.75 x 1.5	Black	MCX
GPS0006	0.5 x 1.75 x 1.5	Black	SMB
GPS0008	0.5 x 1.75 x 1.5	Black	No Conn
GPS0010	0.5 x 1.75 x 1.5	Black	SMA
GPS0012	0.5 x 1.75 x 1.5	Black	BNC



GPS Single Band Mag Mount

Contact factory for upcoming GNSS models covering GPS, Glonass, Beidou/Compass and Galileo



GPSDM26B0500

GPS DIRECT MOUNT

GPS single band direct mount antennas have the following specifications:

**Frequency:** 1575.4  
**Gain:** 4 dBic  
**LNA Gain:** 25 dB ± 2 dB  
**Pattern:** Hemispherical  
**Mounting:** Direct Feed 5/8" hole

**Polarization:** Right-Hand Circular  
**Coax:** LMR-195  
**Voltage:** 3V-5V DC  
**Color:** Gray (Pantone 427)  
**Size:** .87" H x 1.97" Dia

Model	Cable Length	Connector	Color
GPSDM26B0500	19.68" (500mm)	SMA	Gray (Pantone 427)



GPSSB



W4165



GPSSLMB

GPS & CELLULAR COMBO STEALTH BLADES ADHESIVE MOUNT

Model	Frequency (MHz)	Gain	Dimensions L x W x D (In)	Polarization	Voltage	Color	Coax	Conn
GPSSB800/2170FS	806 - 960	0 dBi	5.4 x 1.5 x .6	Linear Vert	3V or 5VDC	Black	16.4' RG-174	FME
	1710 - 2170	0 dBi						SMA
	1575.4	26 (LNA)						

Contact factory for upcoming GNSS models covering GPS, Glonass, Beidou/Compass and Galileo

W4165 SERIES - MULTIBAND DIRECT MOUNT ANTENNAS : GPS + 3G/ISM

GPS, and 3G (or ISM) combination antenna in a low-profile direct mount package.  
**Size:** 3.94" (Dia.) x 1.38" (H) [100mm Dia. x 35mm height] **Mounting:** Direct Feed ; 3/4" dia. hole required. [19mm dia. hole required]

Model	Application	Frequency (MHz)	Gain (Typical)	Cable	Connection
W4165 (Direct Mount)	GPS	1575.42 +/- 1.023	Antenna RHCP gain: 1 dBic typ. LNA Gain: 26 dB +/- 2dB	RG-174	See Datasheet
	3G (or ISM)	824 - 960 1710-2170	2 dBi 2 dBi	RG-174	See Datasheet
W4165MM (Magnetic Mount)	GPS	1575.42 +/- 1.023	Antenna RHCP gain: 1 dBic typ. LNA Gain: 26 dB +/- 2dB	RG-174	See Datasheet
	3G (or ISM)	824 - 960 1710-2170	2 dBi 2 dBi	RG-174	See Datasheet

Note: Contact factory for additional configurations of LTE, WiFi, and GPS.

Note: Contact factory for models which include Glonass, Beidou/Compass and Galileo navigation.

JAGUAR SERIES - MULTIBAND ANTENNAS : GPS/GNSS + MIMO LTE + WIFI

GPS, LTE and WiFi combination antenna in a low-profile mobile package.  
**Size:** 5.7" (L) x 5.3" (W) x 0.98" (H) [145mm x 135mm x 25mm] **Mounting:** Adhesive Mount

Model	Application	Frequency (MHz)	Gain	Filtering; LNA Voltage	Connection
GPSSLMB401	GNSS	1561.098 +/- 2.046 (Beidou)	Antenna RHCP gain: 1 dBic typ. LNA Gain: 30 dB +/- 2dB	OOB Rej.: 60-70dB LNA Input: 3.3 - 5 Vdc Input	See Datasheet
		1575.42 +/- 1.023 (GPS)			
		1602.563 +/- 4.0 (GLONASS)			
	LTE 1	698-960	4.4 dBi (peak)	--	See Datasheet
		1710 - 2690	5.4 dBi (peak)		
	LTE 2	698-960	4.4 dBi (peak)	--	See Datasheet
		1710 - 2690	5.4 dBi (peak)		
	WiFi	2400-2500	4.5 dBi (peak)	--	See Datasheet
		4900 - 5950	6 dBi (peak)		
	LPMB401	LTE 1	698-960	4.4 dBi (peak)	--
1710 - 2690			5.4 dBi (peak)		
LTE 2		698-960	4.4 dBi (peak)	--	See Datasheet
		1710 - 2690	5.4 dBi (peak)		
WiFi 1		2400-2500	5 dBi (peak)	--	See Datasheet
		4900 - 5950	6 dBi (peak)		
WiFi 2	2400-2500	5 dBi (peak)	--	See Datasheet	
	4900 - 5950	5 dBi (peak)			

Note: Contact factory for additional configurations of LTE, WiFi, and GPS. Contact factory for magnetic mount and direct mount configurations.



GPS Multi Band  
Mag Mount

GPS MAGNETIC MOUNT

GPS & Cellular combo magnetic mount antennas have the following specifications:

- Frequency:** 824-960 / 1710-2170 / 1575.4 MHz
- Gain:** 2 dBi / 2 dBi / 5 dBic
- LNA Gain:** 26 dB ± 2 dB
- Pattern:** Omni / Omni / Hemispherical
- Polarization:** Vertical / Vertical / Right-Hand Circular
- VSWR:** Less than 2:1
- Cable:** 17' RG-174
- Voltage:** 3V or 5V DC

Model	Size H x L x W (In)	Color	Connector
GPSCPM00	1.3 x 7.6 x 3.4	Black	TNC/SMA
GPSCPM02	1.3 x 7.6 x 3.4	Black	No Conn/SMA

Contact factory for LTE versions.

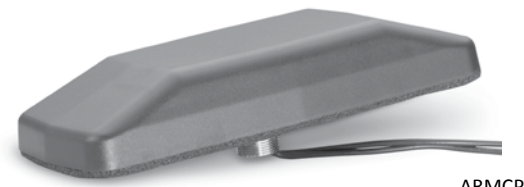

ARMCP

ARMADILLO SERIES - MULTIBAND VEHICULAR DIRECT MOUNT ANTENNAS : GPS + LTE + WIFI

GPS, LTE and WiFi combination antenna in a low-profile mobile package.

Size: 7.6" (L) x 3.4" (W) x 1.32" (H)

[193mm x 86.4mm x 33.5mm]

Mounting: Direct Feed ; 3/4" hole required.

Model	Application	Frequency (MHz)	Gain (Typical)	Connection
ARMCP402	GPS/Glonass/Beidou	1559-1607	Antenna RHCP gain: 1 dBic typ. LNA Gain: 30 dB +/- 2dB	SMA (m)
		698-960	2 dBi	SMA (m)
	LTE1, LTE2	1710-2690	4 dBi	SMA (m)
		2400-2500	4 dBi	RP-SMA (m)
WiFi	5150-5925	6 dBi		

Note: Contact factory for additional configurations of LTE, WiFi, and GPS. Contact factory for magnetic mount and adhesive mount configurations. White Housing is available.

GPS LTE WI-FI MULTI BAND DIRECT MOUNTS

Model	Frequency (MHz)	Gain (dBi)	Polarization	VSWR	Mounting	Voltage	Size H x Dia (In)	Cable	Conn
GPSDM700/2500FFS (3 CABLE)	698-960/1710-2170/2300-2700	3	Linear Vertical	2.0:1	3/4" Hole	3 or 5	3.5 x 4.16	17' RG-58	FME
	2400-2485/5150-5850	6	Linear Vertical					17' RG-58	FME
	1575.42	5 dBic	RHCP					17' RG-174	SMA



GPSDM700/2500  
GPSDM700/5800

ALTERNATE CABLE/CONNECTOR CONFIGURATIONS

MODEL (Black)	MODEL (White)	LTE CABLE	LTE CONN.	GPS CABLE	GPS CONN.	GPS CABLE	GPS CONN.
GPSDM700/5800SSS	GPSDM700/5800SSW	17' RG-58	SMA	17' RG-58	SMA	17' RG-174	SMA
GPSDM700/5800GGT	GPSDM700/5800GGTW	17' RG-58	SMA	17' RG-58	RP-SMA	17' RG-174	SMA



GPSMB501



GPSMB Panther (White)



GPSMB301

PANTHER SERIES - DIRECT MOUNTS

Model	Application	Frequency (MHz)	Gain (dBi)	VSWR	Mount	Size (in.)	Cable	Conn.
GPSMB501 (5 CABLES)	LTE1, LTE2	698-960	4 (LB) 5 (UB)	1.5:1	7/8" Hole (M22 Nut)	6.5x6x3	17' RG-58	SMA
		1695-2170 2300-2700 2900-3600						SMA
	WiFi1, WiFi2	2400-2500 4900-5900	4.5 / 5	1.5:1	7/8" Hole (M22 Nut)	6.5x6x3	17' RG-58	RP-SMA RP-SMA
	GPS, GLONASS	1564-1610	1.5 (dBic)	1.5:1	7/8" Hole (M22 Nut)	6.5x6x3	17' RG-174	SMA
GPSMB301	LTE, LTE2	698-960	6 (LB) 5.5 (UB)	1.7:1	7/8" Hole (M22 Nut)	6.5x6x3	17' RG-58 17' RG-58	SMA
		1695-2170 2300-2700 2900-3600						SMA
	GPS, GLONASS	1575-1609	1.5 (dBic)	1.7:1	7/8" Hole (M22 Nut)	6.5x6x3	17' RG-174	SMA

NOTE: GPSMBMM is a magnetic base for GPSMB501 and GPSMB301. White and black colors available.

**NOTE: All NMO mount antennas listed in this catalog section require the NMOHF-style (high frequency 27 MHz - 6 GHz) mount.**

**PUBLIC SAFETY AND WIFI BROADBAND ANTENNAS**

Model	Type	Frequency (MHz)	Gain (dBi)	Max Height (in)	VSWR	Cable Assembly
EF2405NMO	Elevated Feed	2400-2500	5	16	<1.5:1	Order Separately
EF4905NMO	Elevated Feed	4900-5000	5	12	<1.5:1	Order Separately
NMO4E4900B	Elevated Feed	4900-5350	4	4.5	2:1	Order Separately
NMO4E5350B	Elevated Feed	5350-5925	4	4.5	2:1	Order Separately
NMO5E2400B	Collinear	2400-2500	2.95	8.5	1.5:1	Order Separately



EF



NMO4E



NMO5E



Through its rich history in the Larsen and LK brands, Pulse has over 50 years in the antenna business.

**NOTE: All NMO mount antennas listed in this catalog section require the NMOHF-style (high frequency 27 MHz - 6 GHz) mount.**

**PUBLIC SAFETY 700/800; 2G/3G/4G LTE; WIFI; DSRC – LOW PROFILE**

Model Black	Model White	ICEFIN Model	Frequency (MHz)	Gain (dBi)	Mount	Size Hx DIA (in)	Power Rating (Watts) Black / White / ICEFIN
LPT825/19NMOHF	N/A	NA	Cellular: 806-960 PCS: 1710-2170 ISM: 2400	3 3 4	NMOHF	3 x 1.75	10 / 10 / NA
LPT2400NMOHF	LPT2400NMOHFW	NA	2400-2500	5	NMOHF	3 x 1.75	10 / 10 / NA
SLPT698/2170NMOHF	SLPT698/2170NMOHFW	ICEFINLNMOHF	LTE: 698-960 PCS: 1710-2170 ISM: 2400-2700	4.5 5.6 4	NMOHF	3 x 1.75	40 / 40 / 30
SLPT2400NMOHF	SLPT2400NMOHFW	ICEFIN24NMOHF	2400-2500	4.3	NMOHF	2.6 x 1.5	35 / 35 / 30
SLPT4900NMOHF	SLPT4900NMOHFW	ICEFIN49NMOHF	4900-5900	5.5	NMOHF	2.6 x 1.5	35 / 35 / 30
SLPT2400/5900NMOHF	SLPT245NMOHFW	ICEFINWNMOHF	2400-2500 4900-5900	4.3 5.5	NMOHF	2.6 x 1.5	35 / 35 / 30
SLPT698/2170DMN	SLPT698/2170DMNW	ICEFINLDMN	LTE: 698-960 PCS: 1710-2170 ISM: 2400-2700	4.5 5.6 4	Direct (N Female)	3 x 1.75	40 / 40 / 35
SLPT2400DMN	SLPT2400DMNW	ICEFIN24DMN	2400-2500	4.3	Direct (N Female)	2.6 x 1.5	35 / 35 / 30
SLPT4900DMN	SLPT4900DMNW	ICEFIN49DMN	4900-5900	5.5	Direct (N Female)	2.6 x 1.5	35 / 35 / 30

ICEFIN698-960NMO



ICEFIN806DMN



SLPT NMO



SLPT DM



LPT



**WIFI, BROADBAND STEALTH BLADES**

Stealth Blade antennas have a gain of 2.14 dBi, a maximum power of 3 Watts and linear polarization

Model	Frequency (MHz)	Type	Dimensions L x W (in)	Color	Coax	Connector
SB24003	2400-2500	Dipole	3 x .75	Black	3' RG-174	No Conn
SB24006	2400-2500	Dipole	3 x .75	Black	6' RG-174	No Conn
SB2400SMA3	2400-2500	Dipole	3 x .75	Black	3' RG-174	SMA
SB2400SMA6	2400-2500	Dipole	3 x .75	Black	6' RG-174	SMA
SB2400SMB3	2400-2500	Dipole	3 x .75	Black	3' RG-174	SMB
SB2400SMB6	2400-2500	Dipole	3 x .75	Black	6' RG-174	SMB
SB2400MMCX3	2400-2500	Dipole	3 x .75	Black	3' RG-174	MMCX
SB2400MMCX6	2400-2500	Dipole	3 x .75	Black	6' RG-174	MMCX



SB2400xx

LTE, 4G, BROADBAND RADOME OMNIS

**Radome Enclosure: Pultruded Fiberglass (UV Protected)**  
**VSWR: 2.0:1 Power Rating: 20 Watts**  
**Ingress Protection: IP67 Polarization: Vertical**  
**Suggested mounting brackets for N Female connectors are FB2BRACKET or FB3BRACKET. See Page 53 for FB brackets.**

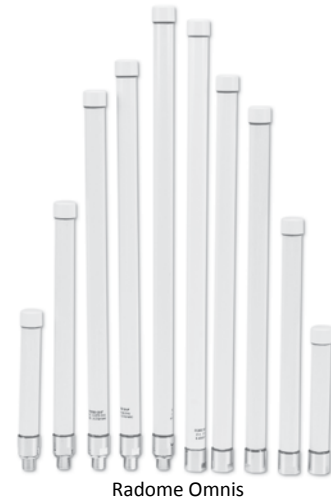

Model	Frequency (MHz)	Gain (dBi)	Length (In)	Connector
W5067 <sup>(1)</sup>	698-960	0.7	9.1	N Female
	1710-2170	1.0		
	2400-2700	2.0		
RO17102NM <sup>(2)</sup>	1710-2170	2	4.5	N Male
RO8605NFC <sup>(3)</sup>	860 - 930	5.0	32	N Female
RO2404NM	2400-2500	4	11.5	N Male
RO2406NF	2400-2500	6	11.5	N Female
RO2406NM	2400-2500	6	11.5	N Male
RO2408NF	2400-2500	8	20	N Female
RO2408NM	2400-2500	8	20	N Male
RO2408NFD (downtilt)	2400-2500	8	20	N Female
RO2408NMD (downtilt)	2400-2500	8	20	N Male
RO2408NFU (uptilt)	2400-2500	8	20	N Female
RO2408NMU (uptilt)	2400-2500	8	20	N Male
RO4910NF	4940-4990	10	18	N Female
RO4910NM	4940-4990	10	18	N Male
RO5206NF	5150-5350	6	6.75	N Female
RO5410NF	5470-5725	10	16.5	N Female
RO5210NF	5150-5350	10	16.5	N Female
RO5210NM	5150-5350	10	16.5	N Male
RO5410NM	5470-5725	10	16.5	N Male
RO5805NF	5150-5825	5	6.75	N Female
RO5805NM	5150-5825	5	6.75	N Male
RO5806NF	5725-5875	6	6.75	N Female
RO5810NF	5725-5875	10	16.5	N Female
RO5810NM	5725-5875	10	16.5	N Male
RO8063/21704NM	806-960	3	8.6	N Male
RO8063/21704NF	1710-2170	4		N Female
RO8061/21702NM	806-960	1	16.5	N Male
	1710-2170	2		
W5030	2400-2500	4	6.8	N Male
	5150-5875	6		
RO3ISMNM	430-440	2	21.3	N Male
	860-930	2.5		
RO25002NF <sup>(2)</sup>	2300-2700	2.0	5.1	N Female

(1) 3 Watt Power (2) PIM Rated to -155 dBc (3) Bracket ROKIT Available. Contact Factory.

YAGIS

**Construction: Fully Welded Elements**  
**VSWR: 2.0:1**  
**Power Rating: 300 Watts**  
**Wind Load: 100 mph**  
**Feed Connection: N Female**  
**Mounting Hardware: Included**

Model	# of Elements	Frequency (MHz)	Gain (dBi)	Length (In)
YA3406WN	5	406-430	11	42.25
YA3450WN	5	450-470	11	36.25
YA5740W	7	740-806	11	32.75
YA6740W	4	740-806	8	19.25
YA5800W	7	806-866	11	31.25
YA6800W	4	806-866	8	17.5
YA5825W	7	824-896	11	31.25
YA6825	4	824-896	8	17.5
YA5900W	7	890-960	11	30
YA6900W	4	890-960	8	17.5

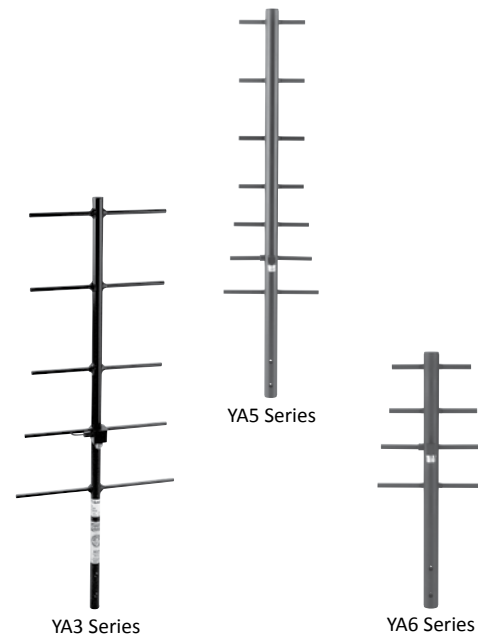

OMNI BASE STATION ANTENNAS

**Omni Base Station part numbers ending in "WA" do not include mounting hardware.**  
**All others includes the appropriate FB2BRACKET or FB3BRACKET for mounting. See Page 78 for FB brackets.**

Model	Type	Frequency (MHz)	Gain (dBi)	Max Height (In)	Power Rating (Watts)	Whip Color	Feed Connection
BSA45C	Base Loaded 1/4 λ	45-50	2	51.75	200	Stainless	N Female
BSA118B	5/8 λ	118-121	5.2	64	200	Black	UHF Female
BSA132B	5/8 λ	131-135	5.2	54.5	200	Black	UHF Female
BSA150B	5/8 λ	144-174	5.2	51.75	200	Black	UHF Female
BSA150C	5/8 λ	144-174	2.5	51.75	200	Black	UHF Female
BSA220C	5/8 λ	200-225	5.2	33.75	200	Stainless	UHF Female
BSA406C	5/8 over 1/2 λ	406-420	5.6	32	200	Stainless	UHF Female
BSA440C	5/8 over 1/2 λ	440-460	5.6	32	200	Stainless	UHF Female
BSA450C	5/8 over 1/2 λ	450-470	5.6	32	200	Stainless	UHF Female
BSAKIT	Base Station Ground Plane Kit			200			UHF Female
FB1136	5/8 over 1/2 λ	136-230	5.6	96	200	Stainless	UHF Female
FB2406	5/8 over 1/4 λ	406-420	5.4	32.5	200	Black	N Female
FB2450	5/8 over 1/4 λ	450-470	5.4	32.5	200	Black	N Female
FB2406W/A	5/8 over 1/4 λ	406-420	5.4	32.25	200	Black	N Female
FB2420W/A	5/8 over 1/4 λ	420-440	5.4	32.25	200	Black	N Female
FB2450W/A	5/8 over 1/4 λ	450-470	5.4	32.25	200	Black	N Female
FB3800	5/8 over 1/4 λ	806-866	5.4	16	150	Black	N Female
FB3825	5/8 over 1/4 λ	824-896	5.4	16	150	Black	N Female
FB3740WA	5/8 over 1/4 λ	740-806	5.4	16	150	Black	N Female
FB3800WA	5/8 over 1/4 λ	806-866	5.4	16	150	Black	N Female
FB3825WA	5/8 over 1/4 λ	824-896	5.4	16	150	Black	N Female
FB35T800	5/8 over 5/8 over 1/4 λ	806-866	5.4	32	150	Black	N Female
FB35T825	5/8 over 5/8 over 1/4 λ	824-896	5.4	32	150	Black	N Female
FB35T800WA	5/8 over 5/8 over 1/4 λ	806-866	7.2	32	150	Black	N Female
FB35T825WA	5/8 over 5/8 over 1/4 λ	824-896	7.2	32	150	Black	N Female
FB900	5/8 over 1/4 λ	890-960	5.4	16	150	Black	N Female
FB3900WA	5/8 over 1/4 λ	890-960	5.4	16	150	Black	N Female
FB35T900	5/8 over 5/8 over 1/4 λ	890-960	7.2	23	150	Black	N Female
FB35T900WA	5/8 over 5/8 over 1/4 λ	890-960	7.2	23	150	Black	N Female
FB45T2400	5/8 over 5/8 over 1/4 λ	2400-2485	7.2	16.5	100	Black	N Female
FB45T2400WA	5/8 over 5/8 over 1/4 λ	2400-2485	7.2	9	100	Black	N Female

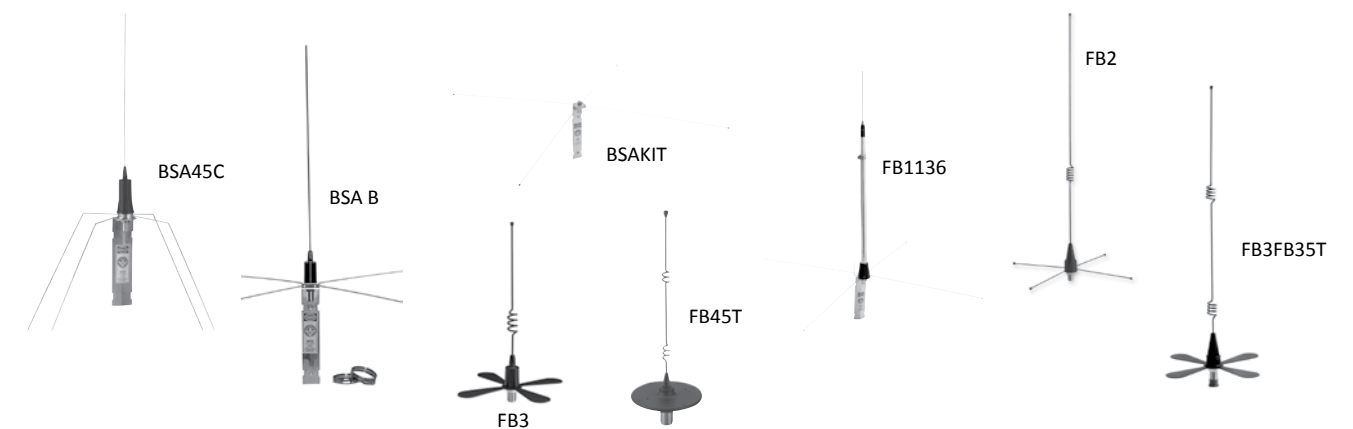



# Maker Of Clarity™ Transparent Antennas!

From Your **PIMinator™** Low-Pim Solutions Expert

**Distributed Antenna Systems:** As consumers switch to a lifestyle of constant internet connection, the demand on wireless networks increases dramatically. The carrier networks are switching from one of coverage to capacity. Previously coverage came via cellular base stations with tower-mounted antennas with vast reach to many consumers. The future networks need to fulfill capacity demands by bringing those networks closer to the consumer, with greater data throughput reaching customers in smaller coverage areas. To meet these very high data rates it's critical to have high quality innovative components such as Pulse Electronics PIMinator™ line of in-building low-PIM antennas, Pulse clarity™ transparent antennas and accessory components.



Clarity™ Transparent Antenna



Clarity™ White Antenna

ULTRA-THIN CLARITY™ ANTENNAS				
Clarity™ Series	Pulse Part Number	Freq, MHz	PIM Rating, dBc	Connector
Ultra-Thin Clear	DASUTCC500NF	608-960/1695-2200/2300-2700MHz, Antenna only	-155	N Female w/500mm pigtail
Ultra-Thin Clear	DASUTCCR500NF	608-960/1695-2200/2300-2700MHz, with Reflector	-155	N Female w/500mm pigtail
Ultra-Thin Clear	DASUTCC500MD	608-960/1695-2200/2300-2700MHz, Antenna only	-155	4.1-9.5 Mini-DIN Female w/500mm pigtail
Ultra-Thin Clear	DASUTCCR500MD	608-960/1695-2200/2300-2700MHz, with Reflector	-155	4.1-9.5 Mini-DIN Female w/500mm pigtail
Ultra-Thin Clear	DASUTCC5004310	608-960/1695-2200/2300-2700MHz, Antenna only	-155	4.3-10 DIN Female w/500mm pigtail
Ultra-Thin Clear	DASUTCCR5004310	608-960/1695-2200/2300-2700MHz, with Reflector	-155	4.3-10 DIN Female w/500mm pigtail
Clarity	DASUTCCACC1	Reflector	N/A	N/A
Ultra-Thin White	DASUTWC500NF	608-960/1695-2200/2300-2700MHz, with Reflector	-155	4.3-10 DIN Female w/500mm pigtail
Ultra-Thin White	DASUTWCR500NF	608-960/1695-2200/2300-2700MHz, with Reflector	-155	4.3-10 DIN Female w/500mm pigtail
Ultra-Thin White	DASUTWC500MD	608-960/1695-2200/2300-2700MHz, with Reflector	-155	4.3-10 DIN Female w/500mm pigtail
Ultra-Thin White	DASUTWCR500MD	608-960/1695-2200/2300-2700MHz, with Reflector	-155	4.3-10 DIN Female w/500mm pigtail
Ultra-Thin White	DASUTWC5004310	608-960/1695-2200/2300-2700MHz, with Reflector	-155	4.3-10 DIN Female w/500mm pigtail
Ultra-Thin White	DASUTWCR500431	608-960/1695-2200/2300-2700MHz, with Reflector	-155	4.3-10 DIN Female w/500mm pigtail



DASLTE500NF



DASLTENF



DASSPLIT3WNF

Antennas	Pulse Part Number	Freq, MHz	PIM Rating, dBc	Connector
MIMO Ceiling Mount	DASLTE500NFMIMO	698-960/1710-2170/2300-2700/4900-5900	-155	N Female w/500mm pigtail (2x)
MIMO Ceiling Mount	DAS500MDMIMO	698-960/1710-2170/2300-2700/4900-5900	-155	Mini-DIN (4.1/9.5) Female w/500mm pigtail
SISO Ceiling Mount	DASLTE500NF	698-960/1710-2170/2300-2700/4900-5900	-155	N Female w/500mm pigtail
SISO Ceiling Mount	DASLTENF	698-960/1710-2170/2300-2700/4900-5900	-155	N Female w/500mm pigtail
SISO Ceiling Mount	DASLTEMINIDIN	698-960/1710-2170/2300-2700/4900-5900	-155	Mini-DIN (4.1 / 9.5) Female w/ 500mm pigtail
SISO Ceiling Mount	DASLTEDIN	698-960/1710-2170/2300-2700/4900-5900	-155	DIN (7 / 16)

RF Splitters	Pulse Part Number	Freq, MHz	PIM Rating, dBc	Connector
Power Splitter, 2-Way, 300W	DASSPLIT2WDIN	698-2700	-155	DIN
Power Splitter, 2-Way, 300W	DASSPLIT2WNF	698-2700	-155	N Female
Power Splitter, 3-Way 300W	DASSPLIT3WNF	698-2700	-155	N Female
Power Splitter, 4-Way, 300W	DASSPLIT4WNF	698-2700	-155	N Female



PSIBVHF and PSIBVU78



Installed Condition:  
PSIBVHF and PSIBVU78



PSUTWCNF

PUBLIC SAFETY DAS PRODUCTS							
Application	Frequency, MHz	Series	Part Number	PIM Rating	Connector	Color	Size (inches / mm)
UHF + 700/800	380-570; 698-960	Clarity™-Pearl	PSUTWCNF	N/A	N-Female	White	12.3" (311mm) Diameter. 0.37" (9.5mm) Below ceiling
VHF	132-174	V-Thinity™	PSIBVHF	N/A	N-Female	White	15.0x15.0 inch (380x380mm) Below Ceiling: 0.060 inch (1.5mm)
VHF+UHF+700/800	132-174; 380-570; 700-960	V-Thinity™	PSIBVU78	N/A	N-Female	White	15.4 x 13.6 inch (391 x 346mm) Below Ceiling: 0.06 inch (1.5mm)"



PSDASxx Series Top View



PSDASxx Series Bottom View

PUBLIC SAFETY + CARRIER COMBO DAS PRODUCT							
Application	Frequency, MHz	Series	Part Number	PIM Rating	Connector	Color	Size (inches / mm)
UHF (Tetra) + 3G/4G LTE (or WiFi)	380-520; 698-960; 1710-2700; 4900-6000	5Bar	PSDAS4310F	N/A	4.3-10	White	11.3 Dia x 5.4 Tall (288mm Dia. X 136mm Tall)
UHF (Tetra) + 3G/4G LTE (or WiFi)	380-520; 698-960; 1710-2700; 4900-6000	5Bar	PSDAS4310FP	-150dBc (@2x20 watts)	4.3-10	White	11.3 Dia x 5.4 Tall (288mm Dia. X 136mm Tall)
UHF (Tetra) + 3G/4G LTE (or WiFi)	380-520; 698-960; 1710-2700; 4900-6000	5Bar	PSDASNF	N/A	N-Female	White	11.3 Dia x 5.4 Tall (288mm Dia. X 136mm Tall)
UHF (Tetra) + 3G/4G LTE (or WiFi)	380-520; 698-960; 1710-2700; 4900-6000	5Bar	PSDASNFP	-150dBc (@2x20 watts)	N-Female	White	11.3 Dia x 5.4 Tall (288mm Dia. X 136mm Tall)

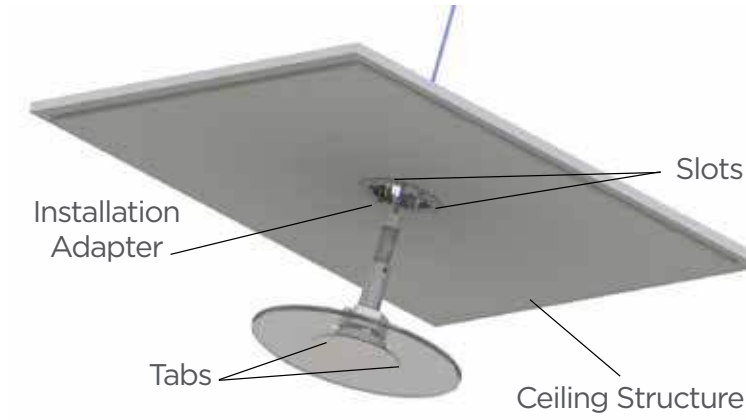

Typical Assembly using the Clarity Installation Adapter



Above-Ceiling Antenna Holder



Above-Ceiling Antenna Holder (Shown with Antenna Installed)

Items	Part Number	Function	Material Size	Comments
Above-Ceiling Antenna Holder	DASACHOLDER	Support antennas above ceiling tile rails.	Polycarbonate; 618x192x122 mm (24.4x7.6x4.4 inch)	The holder includes snap-in-place brackets for easy installation onto most standard ceiling tiles rails. Antennas are robustly held in place so the antennas cannot be disturbed when building tenant moves ceiling tiles and impacts the antenna. The plastic construction ensures PIM is not aggravated unlike competitive ferrous metal holders.
Clarity Installation Adapter	DASCLINSERT	Blind-hole installation of Clarity Antennas.	94 mm dia (3.7 inch dia)	The Installation adapter allows one-sided (blind-hole) installation of Clarity antennas when the building construction does not provide access to the backside of the antenna for installation of the provided nut. Ideal for hardpan, drywall, plank and other architectural ceiling types.
PIM-Blocker Absorber	DASACABSORBER	System PIM Reduction	(19.7 x 19.7 x 2.0 inch)	The PulseLarsen PIM Blocker absorber bag can reduce PIM by as much as 40dB when placed between antennas and the surrounding structure. The PulseLarsen PIM Blocker can also be used to improve isolation in BDA Repeater applications. See Datasheet for more details.



DAS PIM-Blocker Absorber



Clarity Installation Adapter



ICEFIN Transparent



ICEFIN White

LOW COST MONOPOLE WITH GROUND PLANE SOLUTION

Application	Frequency, MHz	SLPT White Series Antenna		IceFin™ Series Antenna		Peak Gain*	PIM Rating	Connector	Mechanical Properties
		Color	Part Number	Color	Part Number				
700 / 800	698-869	White	SLPT698/869DMNW	Transparent	ICEFIN698/869DMN	3.3 dBi	None	N-Female	1.5" dia x 3.1" tall (38mm dia. X 79 mm tall)
2G / 3G / 4G LTE	698-960 / 1710-2700	White	SLPT698/2170DMNW	Transparent	ICEFINLDMN	3.5 dBi (lower band) 4.95 dBi (upper band)	None	N-Female	1.5" dia x 3.1" tall (38mm dia. X 79 mm tall)

\* Gain when using ground plane



Installed Configuration



Installed Configuration



Frame and Screws



Ground Plane

Application	Part Number	Mechanical Properties
Ground Plane (for use with above antennas)	ICEFIN-GP	15.75" Dia. X 0.040" thk (400mm Dia. X 1mm thk) Material: Aluminum"
Frame (for use with above antennas)	ICEFIN-F	2.95" Dia. (74.9mm Dia).



IN-BUILDING ANTENNA	FREQUENCY (MHZ)	HEIGHT (IN/MM)	GAIN (DBI)	CONNECTOR
Single Band Baton Style				
RO17102NM	1710-2170	4.5 / 115	2	N Female w/ 500mm pigtail
Multi Band Baton Style				
W5067	698 - 960 / 1710 - 2170 / 2400 - 2700	9.1 / 230	1 / 2	N Female
RO8061/21702NF	806-960/1710-2170	8.5 / 216	1 / 2	N Female
RO8061/21702NM	806-960/1710-2170	8.5 / 216	1 / 2	N Male
RO8063/21704NF	806-960/1710-2170	15.3 / 389	3 / 4	N Female
RO8063/21704NM	806-960/1710-2170	15.3 / 389	3 / 4	N Male
W5030	2.4-2.5/5.15-5.875 GHz	6.8 / 173	4 / 6	N Male
Public Safety Antennas				
Donor Yagi	YA34xxWN	406 thru 512Mhz	11 dBi	N Female
Donor Yagi	YA5xxW	740 thru 960	11 dBi	N Female
Donor Yagi	YA6xxW	740 thru 960	8 dBi	N Female
Base Station	FB24xx WA	406 thru 470	5.4 dBi	N Female
Base Station	FB3xxx	740 thru 960	5.4 dBi	N Female
Base Station	FB35T900x	902 thru 928	7.2 dBi	N Female

\*\*See specific datasheet for Part Number and coverage frequency.

All Larsen NMOHF (high frequency 27 MHz to 6 GHz) mounts convert from low frequency applications to high frequency applications and back by pulling or replacing the center pin and insulator.

NMOHF mounts require a 3/4" hole for mounting and include 17' of coax. NMOHF mounts accommodate roof surfaces from 0.1" to .03". NMOHFTHK (thick) mounts accommodates roof surfaces up to 1/2" thick.

NMO 3/4" HIGH FREQUENCY MOUNTS

Model	Coax	Connector
NMOKHFCX	CX (RG-58A/U)	No Conn
NMOKHFCXFME	CX (RG-58A/U)	FME CRIMP
NMOKHFCXMPL	CX (RG-58A/U)	MPL
NMOKHFCXPL	CX (RG-58A/U)	PL-259
NMOKHFDS	DS (RG-58A/U Dual Shield)	No Conn
NMOKHFUD	UD (RG-58U Dual Shield)	No Conn
NMOKHFUDFME	UD (RG-58U Dual Shield)	FME
NMOKHFUDMPL	UD (RG-58U Dual Shield)	MPL
NMOKHFUDSMA	UD (RG-58U Dual Shield)	SMA
NMOKHFUDTNC	UD (RG-58U Dual Shield)	TNC
NMOKHF200SMAI	LMR200	SMA Installed

NMO 3/4" HIGH FREQUENCY MID-SIZE MOUNTS

Model	Coax	Connector
NMOKHFMIDCX	CX (RG-58A/U)	No Conn
NMOKHFMIDDS	DS (RG-58A/U Dual Shield, Low Loss)	No Conn
NMOKHFMIDUD	UD (RG-58U, Dual Shield)	No Conn

NMO 3/4" HIGH FREQUENCY THICK MOUNTS

Model	Coax	Connector
NMOKHFCXTHK	CX (RG-58A/U)	No Conn
NMOKHFDSTHK	DS (RG-58A/U Dual Shield)	No Conn

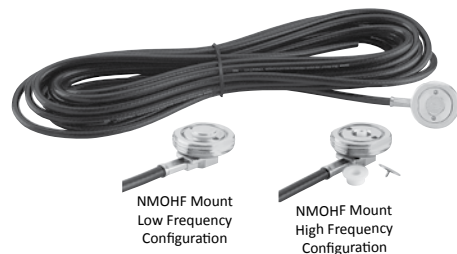

NMO HIGH FREQUENCY MOUNTS

Model	Thickness	Cable
NMOHF	0761-2.54 mm Standard	Not included
NMOHFMID	0.761 - 5.90 mm Mid-Thickness	Not included
NMOHFTHK	1.6 - 12.7 mm Greatest Thickness	Not included

All Larsen NMOHF (high frequency 27 MHz to 6 GHz) mounts convert from low frequency applications to high frequency applications and back by pulling or replacing the center pin and insulator.

NMO HIGH FREQUENCY MAGNETIC MOUNTS

NMOHF round magnetic mounts have the following specifications:

Size: 3.5" Diameter  
 Cable Length: 12'  
 Pull Strength: 80 lbs

Model	Coax	Connector
NMOMMRNOCONN	CX (RG-58A/U)	No Conn
NMOMMR	CX (RG-58A/U)	58FCP
NMOMMRFME	CX (RG-58A/U)	FME Crimp
NMOMMRPL	CX (RG-58A/U)	PL-259
NMOMMRMPL	CX (RG-58A/U)	MPL Crimp
NMOMMRTNC	CX (RG-58A/U)	TNC Crimp
NMOMMRBNC	CX (RG-58A/U)	BNC Crimp
NMOMMRN	CX (RG-58A/U)	N Crimp
NMOMMRDS	DS (RG-58A/U Dual Shield)	No Conn
NMOMMRDSFME	DS (RG-58A/U Dual Shield)	FME
NMOMMRDSMPL	DS (RG-58A/U Dual Shield)	MPL Crimp
NMOMMRDSN	DS (RG-58A/U Dual Shield)	N Crimp
NMOMMRDSSMA	DS (RG-58A/U Dual Shield)	SMA
NMOMMRDSSMAR/P	DS (RG-58A/U Dual Shield)	SMARP
NMOMMRDSPL	DS (RG-58A/U Dual Shield)	PL-259T
NMOMMRDSTNC	DS (RG-58A/U Dual Shield)	TNC
NMOMMT200NOCONN	LMR200	No Conn
NMOMMR200SMA	LMR200	SMA
NMOMMR200N	LMR200	N

If your antenna has a "tab" or "pin" connector, use the NMOHF mount in the low frequency configuration - leave the center pin and insulator in place as it arrives from the factory.

If your antenna has a "high frequency" (HF) connector, use the NMOHF mount in the high frequency configuration - remove the center pin and insulator.



NMO 3/4" STANDARD MOUNTS

NMO 3/4" standard mounts require a 3/4" hole for mounting and include 17' of coax.

Model	Coax	Connector
NMOKNOCONN	CX (RG-58A/U)	No Conn
NMOK	CX (RG-58A/U)	PL-259
NMOKFME	CX (RG-58A/U)	FME
NMOKMPL	CX (RG-58A/U)	MPL Crimp
NMOKDS	DS (RG-58A/U Dual Shield)	No Conn
NMOKDSFME	DS (RG-58A/U Dual Shield)	FME
NMOKUD	UD (RG-58U Dual Shield)	No Conn
NMOKUDFME	UD (RG-58U Dual Shield)	FME
NMOKUDPL	UD (RG-58U Dual Shield)	PL-259T
NMOKUDTNC	UD (RG-58U Dual Shield)	TNC

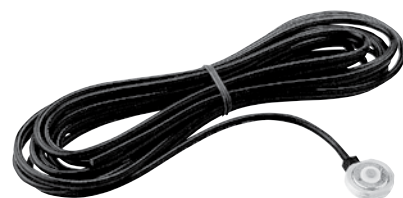

NMO 3/8" THICK MOUNTS

NMO3/8" mounts have the following specifications:

Mounting: 3/4" hole  
 Mounting Surface: 0.15" to 0.22" thickness  
 Cable Length: 17'

Model	Coax	Connector
NMOKCX38THK	CX (RG-58A/U)	No Conn
NMOKUD38THK	DS (RG-58A/U Dual Shield)	No Conn

All Larsen NMOHF (high frequency 27 MHz to 6 GHz) mounts convert from low frequency applications to high frequency applications and back by pulling or replacing the center pin and insulator.

GPS LTE DIRECT MOUNTS

NMOHFGPS mounts have the following specifications:

<b>Frequency:</b> 1575.4 - 1576.4 MHz	<b>Gain:</b> 5 dBic
<b>Polarization:</b> Right-Hand Circular / Vertical	<b>LNA Gain:</b> 26 dB ± 2 dB
<b>Cable:</b> 16.4' RG-174 (GPS)	<b>VSWR:</b> Less than 2:1
<b>        16.4' RG-58 (NMOHF)</b>	<b>Size:</b> .5 x 2 x 4.5
<b>Voltage:</b> 3 or 5 V DC	<b>Color:</b> Black
<b>Mounting:</b> 5/8 " Hole	

Model	Connectors
NMOHFGPSFMENOCNN	FME/No Connector
NMOHFGPSFMESMA	FME/SMA
NMOHFGPSNOCNN	No Connectors
NMOHFGPSSMASMA	SMA/SMA

**NOTE:** Specifications listed refer to GPS performance. Additional antenna specifications are dependent on the antenna mounted on the NMO side.

NMO SQUARE MAGNETIC MOUNTS

NMO square magnetic mounts have the following specifications:

<b>Size:</b> 3.5" x 3"
<b>Cable Length:</b> 12'
<b>Pull Strength:</b> 50 lbs

Model	Coax	Connector
NMOMMNOCONN	CX (RG-58A/U)	No Conn
NMOMMMPL	CX (RG-58A/U)	MPL
NMOMM	CX (RG-58A/U)	58FCP
NMOMMBNC	CX (RG-58A/U)	BNC
NMOMMPL	CX (RG-58A/U)	PL-259
NMOMMFME	CX (RG-58A/U)	FME
NMOMMDSFME	DS (RG-58A/U Dual Shield)	FME

NMO TRUNK LID MOUNTS

NMO trunk lid mounts have the following specifications:

Size: 2.5" x 2"

Model	Coax	Cable Length	Connector
NMOTLP	CX (RG-58A/U)	17 ft.	PL-259
NMOTLPFME	CX (RG-58A/U)	17 ft.	FME
NMOHFTLP200NF	LMR-200	17 ft.	N-Female
NMOHFTLP200NF12	LMR-200	12 ft.	N-Female



LM MOUNTS

Model	Coax	Connector
LMKNOCONN	CX (RG-58A/U)	No Conn
LMKFME	CX (RG-58A/U)	FME
LMK	CX (RG-58A/U)	PL-259
LMKDS	DS (RG-58A/U Dual Shield)	No Conn
LMKDSFME	DS (RG-58A/U Dual Shield)	FME
LMKUD	UD (RG-58U Dual Shield)	No Conn
LMKUDFME	UD (RG-58U Dual Shield)	FME

LMMM MAGNETIC MOUNTS

LM magnetic mounts have the following specifications:

<b>Size:</b> 3.5" x 3"	<b>Cable Length:</b> 12'
<b>Type:</b> 5/16" x 24 THDS	<b>Pull Strength:</b> 50 lbs

Model	Coax	Connector
LMMMFMME	CX (RG-58A/U)	FME Crimp
LMMMPL	CX (RG-58A/U)	MPL Crimp
LMMM	CX (RG-58A/U)	58FCP
LMMMBNC	CX (RG-58A/U)	BNC Crimp
LMMMPL	CX (RG-58A/U)	PL-259
LMMMDS	DS (RG-58A/U Dual Shield)	No Conn
LMMMDSFME	DS (RG-58A/U Dual Shield)	FME

LM TRUNK LID MOUNTS

LM trunk lid mounts have the following specifications:

<b>Size:</b> 2.5" x 2"	<b>Cable Length:</b> 17'
<b>Type:</b> 5/16" x 24 THDS	

Model	Coax	Connector
LMTLP	CX (RG-58A/U)	PL-259
LMTLPDS	DS (RG-58A/U Dual Shield)	Order Separately

PO MOUNTS

Model	Coax	Connector
POKNOCONN	CX (RG-58A/U)	No Conn

PO MAGNETIC MOUNTS

PO magnetic mounts have the following specifications:

<b>Size:</b> 3.5" x 3"	<b>Cable Length:</b> 12'
<b>Type:</b> SO-239 Female	<b>Pull Strength:</b> 50 lbs

Model	Coax	Connector
POMM	CX (RG-58A/U)	58FCP

SMA CONNECTORS



MODEL	DESCRIPTION
SMACP58	SMA Crimp Plug 58/U
CABLE GROUP	58



MODEL	DESCRIPTION
SMACJ	SMA Crimp Jack 58/U
CABLE GROUP	58

BNC CONNECTORS



MODEL	DESCRIPTION
BNCCRIMP	BNC Crimp Plug 58/U
CABLE GROUP	58



MODEL	DESCRIPTION
BNCCJ58	BNC Crimp Jack 58/U
CABLE GROUP	58



MODEL	DESCRIPTION
BNC174	BNC Crimp Plug 174/U
CABLE GROUP	174

N CONNECTORS



MODEL	DESCRIPTION
NCRIMP	N Crimp Plug 58/U
CABLE GROUP	58



MODEL	DESCRIPTION
N8	N Clamp Plug 8/U
CABLE GROUP	8



MODEL	DESCRIPTION
NCBJ58	N Crimp Blk Jack 58/U
CABLE GROUP	58

TNC CONNECTORS



MODEL	DESCRIPTION
TNCCRIMP	TNC Crimp Plug 58/U
CABLE GROUP	58



MODEL	DESCRIPTION
TNC	TNC Clamp Plug 58/U
CABLE GROUP	58



MODEL	DESCRIPTION
TNCCJ	TNC Crimp Jack 58/U
CABLE GROUP	58



MODEL	DESCRIPTION
TNCCBJ	TNC Crimp Blk Jack 58/U
CABLE GROUP	58



MODEL	DESCRIPTION
TNCAP	TNC Angle Plug 58/U
CABLE GROUP	58

UHF CONNECTORS



**MODEL** DESCRIPTION  
MPLCRIMP M/UHF Crimp Plug 58/U  
CABLE GROUP 58



**MODEL** DESCRIPTION  
MPLCP M/UHF Crimp Plug 174/U  
CABLE GROUP 174

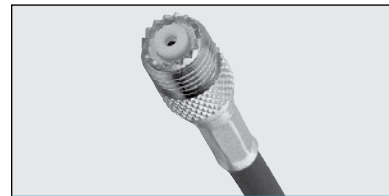

**MODEL** DESCRIPTION  
MPLCJ58 M/UHF Crimp Jack 58/U  
CABLE GROUP 58



**MODEL** DESCRIPTION  
PL2598PHN UHF Solder Plug PL259/U  
CABLE GROUP 8

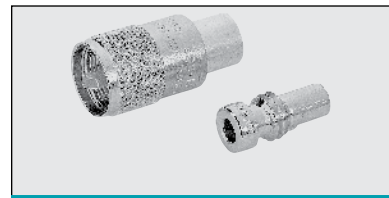

**MODEL** DESCRIPTION  
PL259T UHF Solder Plug PL259/U with UG175 adapter  
CABLE GROUP 8/58

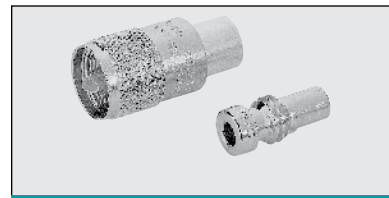

**MODEL** DESCRIPTION  
PL259 UHF Solder Plug PL259/U with UG175 adapter  
CABLE GROUP 8/58

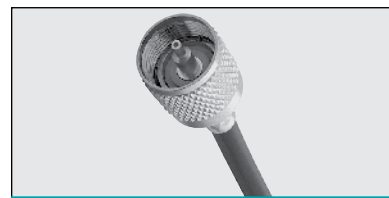

**MODEL** DESCRIPTION  
PLCP UHF Crimp Plug 58/U  
CABLE GROUP 58

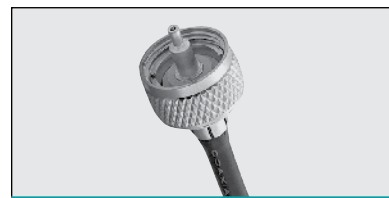

**MODEL** DESCRIPTION  
58FCP UHF FCP Plug 58/U  
CABLE GROUP 58



**MODEL** DESCRIPTION  
PL2598 UHF Solder Plug PL259/U, Teflon & Silver Plate  
CABLEGROUP 8/58

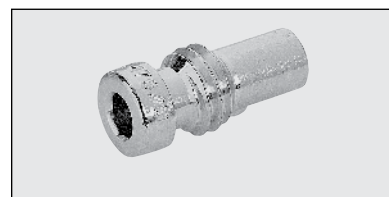

**MODEL** DESCRIPTION  
UG175 UHF Reducing adapter 58/U  
CABLE GROUP 58



**MODEL** DESCRIPTION  
PL258 UHF adapter J/J



**MODEL** DESCRIPTION  
UHFBJJ UHF bulkhead

FME CONNECTORS



**MODEL** DESCRIPTION  
FMECP58 FME Crimp Plug 58/U  
CABLE GROUP 58



**MODEL** DESCRIPTION  
FMECRIMP FME Crimp Jack 58/U  
CABLE GROUP 58



**MODEL** DESCRIPTION  
FMECJ174 FME Crimp Jack 174/U  
CABLE GROUP 174



**MODEL** DESCRIPTION  
FB FME adapter to BNC plug



**MODEL** DESCRIPTION  
FT FME adapter to TNC plug



**MODEL** DESCRIPTION  
FM FME adapter to mini-UHF plug



**MODEL** DESCRIPTION  
FN FME adapter to N plug



**MODEL** DESCRIPTION  
FP FME adapter to UHF plug

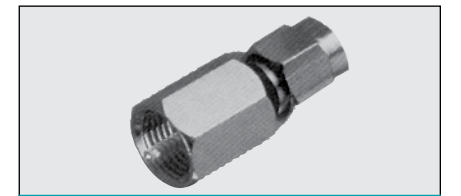

**MODEL** DESCRIPTION  
FSM FME adapter to SMA plug

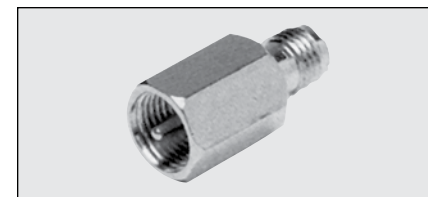

**MODEL** DESCRIPTION  
FSF FME adapter to SMA jack



MODEL	DESCRIPTION
6 x 32	Set Screws
8 x 32	Set Screws



MODEL	DESCRIPTION
A4	BSA/BA/SO-239 to NMO mount adapter



MODEL	DESCRIPTION
BA	Bulkhead mount adapter with hardware



MODEL	DESCRIPTION
GROMMETS	Qty 100 plastic grommet secures/ centers coax, 3/4" hole



MODEL	DESCRIPTION
HP34	Plastic hole plug for 3/4" hole
HP38	Plastic hole plug for 3/8" hole



MODEL	DESCRIPTION
HS1	3/4" hole saw fits 3/8" or larger drills



MODEL	DESCRIPTION
BAHEXNUT	Hex nut for BA



MODEL	DESCRIPTION
BALL1B	Black teardrop rod tip for W490, W540 tapered rods
BALL2B	Black teardrop rod tip for Q and NMOQ antennas
BALL3B	Black teardrop rod tip for .100 diameter non-tapered rods
BALL4	Rod tip WBQ800 antennas



MODEL	DESCRIPTION
BANOHardware	Bulkhead mount adapter without hardware



MODEL	DESCRIPTION
HSBLADE	Replacement blades for HS1



MODEL	DESCRIPTION
KGREINSTALL	KG glass mount installation kit die cut tape



MODEL	DESCRIPTION
KGREINSTALLDC	KG glass mount installation kit die cut tape

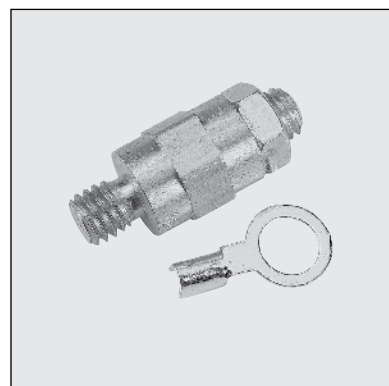

MODEL	DESCRIPTION
BATTBOLT	Battery bolt with terminals, 3/8" ring leads

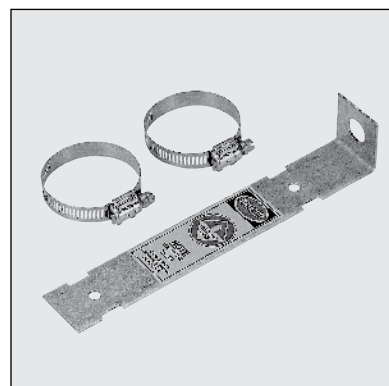

MODEL	DESCRIPTION
FB2BRACKET	Mounting bracket and hardware for FB2 series

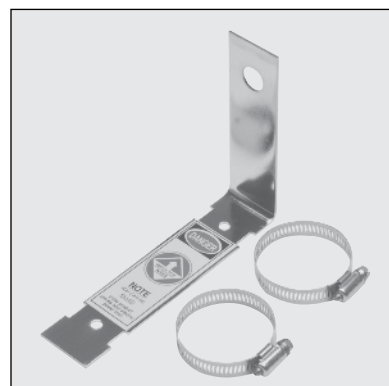

MODEL	DESCRIPTION
FB3BRACKET	Mounting bracket and hardware for blade and round FB antennas

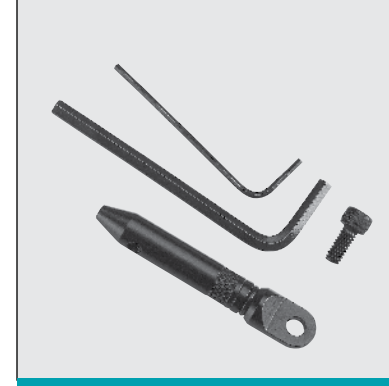

MODEL	DESCRIPTION
KGSWIVEL.073	KG swivel mount assembly, .073 dia
KGSWIVEL.100	KG swivel mount assembly, .100 dia

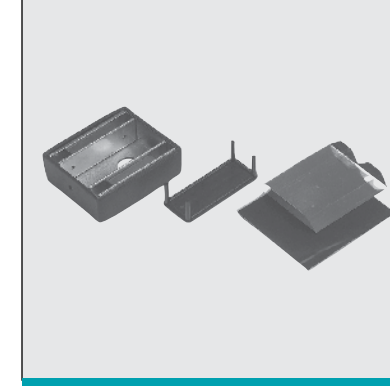

MODEL	DESCRIPTION
MM34	Rectangular mag mount housing, 3/4" hole



MODEL	DESCRIPTION
NMOBRASSRING	Nickel plated brass ring for NMO and NMOHF mounts





**MODEL** DESCRIPTION  
 NMOCAPB Rain cap for NMO mount



**MODEL** DESCRIPTION  
 HFCENTERCONTACT NMOHF Center Contacts and Insulators - 10 each



**MODEL** DESCRIPTION  
 NMOTEST1 Test adapter for NMO mount

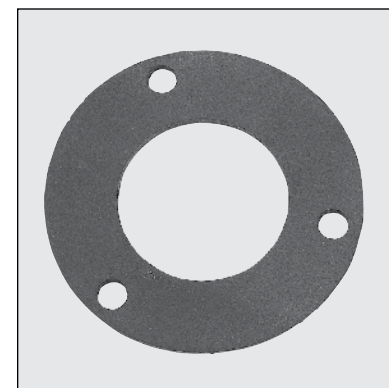

**MODEL** DESCRIPTION  
 RGOMANT Rubber gasket for OM bases

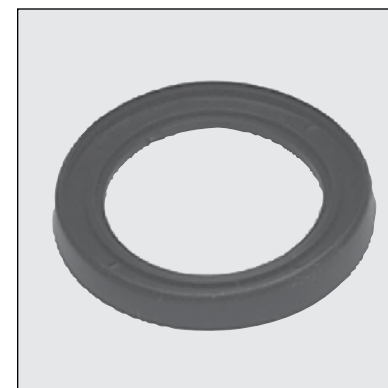

**MODEL** DESCRIPTION  
 RGSS Rubber SuperSeal gasket for MakroBlend® coils / bases

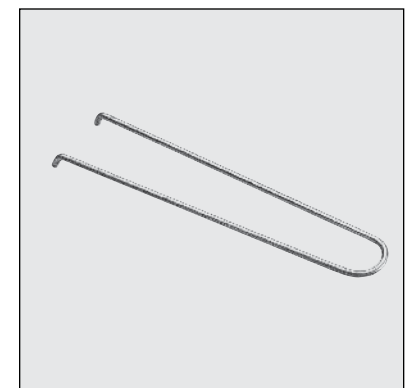

**MODEL** DESCRIPTION  
 SPANNER Spanner wrench for PO and NMOK mounts

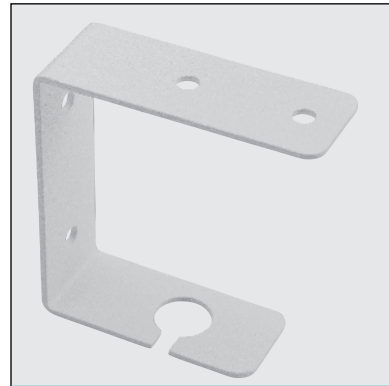

**MODEL** DESCRIPTION  
 OCBRACKET 3" Tall bracket for ceiling or wall mount, Cool Grey

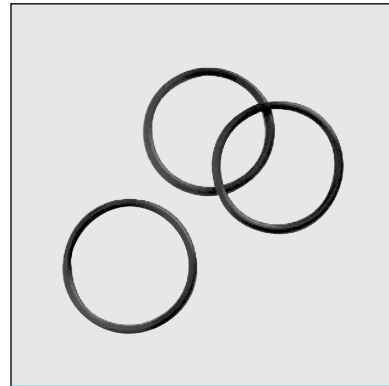

**MODEL** DESCRIPTION  
 OLMMNT O ring for LM mount  
 ONMOANT O ring for NMO antennas/bases  
 ONMOMNT O ring for NMO mount  
 OPOMNT O ring for PO mount



**MODEL** DESCRIPTION  
 QCONE.073 Chrome Q cone / Q base, .073 dia.  
 QCONE.100 Chrome Q cone / Q base, .100 dia.  
 QCONE.125 Chrome Q cone / Q base, .125 dia.



**MODEL** DESCRIPTION  
 SPRING Chrome shock spring



**MODEL** DESCRIPTION  
 SPRINGB Black shock spring

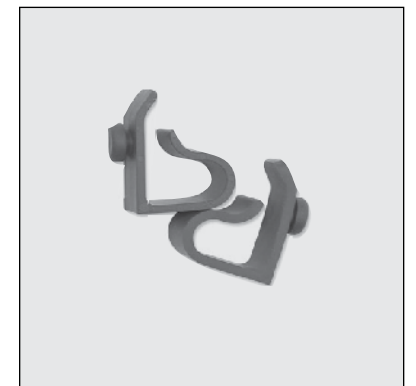

**MODEL** DESCRIPTION  
 WACLIP Mounting clips for WA700/2700 Series - 2 per package



**MODEL** DESCRIPTION  
 QCONE.073B Black Q cone / Q base, .073 dia.  
 QCONE.100B Black Q cone / Q base, .100 dia.  
 QCONE.125B Black Q cone / Q base, .125 dia

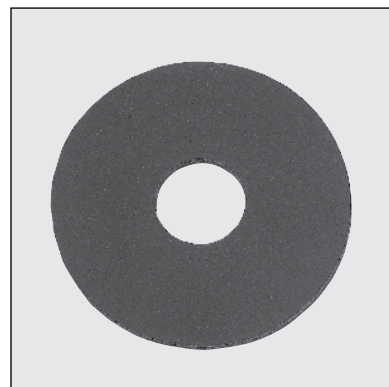

**MODEL** DESCRIPTION  
 RGFBIANT Rubber gaskets for FB1 antenna

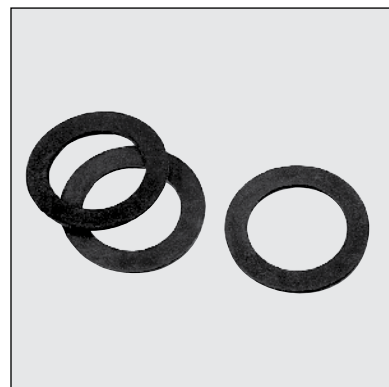

**MODEL** DESCRIPTION  
 RGNMOANT Rubber gasket for NMO coil/bases  
 RGPOMNT Rubber gasket for PO mounts

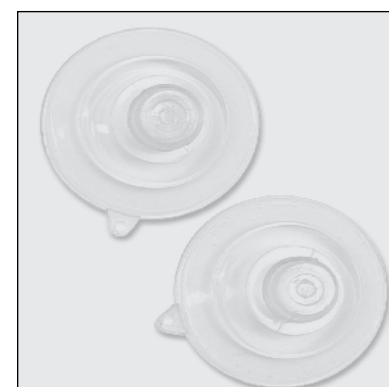

**MODEL** DESCRIPTION  
 WASUCTIONCUP Suction cup mounts for WA700/2700 Series - 2 per package

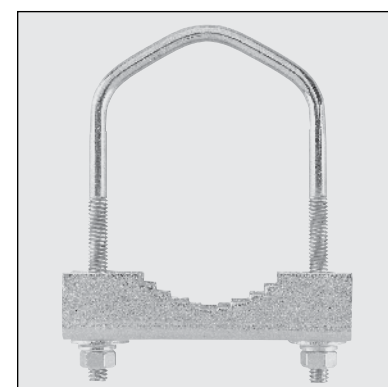

**MODEL** DESCRIPTION  
 YAGIKITHD Mounting hardware for 2 1/2" pipe for YA3, YA5 and YA6 antennas



**MODEL** DESCRIPTION  
 TMB34 Trunk Mount Bracket (Black)  
 TBM34B Trunk Mount Bracket (Black)

COAX TYPES/PART NUMBERS



RG-174 - Small Diameter Coax

RG-174 is the industry standard for applications requiring a small diameter, highly flexible coax. Frequently used in mobile mag mount applications. Subject to higher losses at higher frequencies. Good performance for environmental variations but lower in overall ruggedness.

Recommended Applications

Mobile/Portable less than 900 MHz where flexibility and small diameter is important.

Larsen Part Number: RG-174  
Stocking Lengths: 1000'/Spool  
Cut to order



RG-213 - Stranded Bare Braid - Mil Spec QPI

This RG-8-sized cable uses a stranded center conductor with a polyethylene dielectric and PVC jacket. Built to Mil Specs this cable is used in all Larsen UHF/VHF products targeted for outdoor installation.

Recommended Applications

For lower frequency applications requiring high ruggedness.

Larsen Part Number: RG-213  
Stocking Lengths: 500' or 1000'/Spool  
Cut to order



RG-58U - Low Loss Dual Shield with Solid Center Conductor (UD)

This is Larsen's premium coax for 800 and 900 MHz applications. The solid center conductor (20 AWG) is easy to use with all connectors. Digital applications benefit from the 100% Duofoil aluminum shield. The shield is not glued to the dielectric making it easier to peel back for connector installation. The braid is 95% coverage. This cable is standard for most mounting kits over 800 MHz and can be special ordered with other frequencies. Uses standard RG-58 connectors.

Recommended Applications

For all applications at 800 MHz and above

Larsen Part Number: UD Coax  
Stocking Lengths: 1000'/Spool  
Cut to order



RG-58A/U - CX Standard Coax

The industry standard in quality, value-priced coax. Stranded center conductor offers good flexibility and long-life under most conditions. Not typically recommended for applications above 512 MHz due to higher losses. Uses standard RG-58 connectors.

Recommended Applications

General applications under 512 MHz. First choice for value priced coax.

Larsen Part Number: CX Coax  
Stocking Lengths: 1000'/Spool  
Cut to order



RG-58A/U - "Digi-Shield"™ Low Loss Braided Center

Employs two shields, consisting of a full aluminum/mylar wrap covered by a braid. This combination of shields, plus low-loss dielectric material and stranded center conductor makes an excellent choice for mobile applications. Performance features include low-loss and high flexibility. Uses standard RG-58 connectors.

Recommended Applications

Higher performance applications where lower loss and flexibility are important. Recommended for applications above 800 MHz.

Larsen Part Number: DS Coax  
Stocking Lengths: 1000'/Spool  
Cut to order

COAX SPECIFICATION COMPARISON

TECHNICAL CHARACTERISTICS OF INSULATION AND JACKET COMPOUNDS

PVC	POLYETHYLENE (SOLID AND FOAM)	TEFLON
Sometimes referred to as vinyl or polyvinyl chloride. Extremely high or low temperature properties cannot be found in one formulation. Certain formulations may have -55° C to +105° C rating. Other common vinyls may have -20° C to +60° C. There are many formulations for the variety of different applications. The many varieties of PVC also differ in pliability and electrical properties. The price range can vary accordingly. Typical dielectric constant values can vary from 3.5 to 6.5.	A very good insulation in terms of electrical properties. Low dielectric constant, a stable dielectric constant over all frequencies, very high insulation resistance. In terms of flexibility, polyethylene can be rated stiff to very hard, depending on molecular weight and density — low-density being the most flexible, and high-density, high-molecular weight formulation being very hard. Moisture resistance is rated excellent. Correct Brown and Black formulations have excellent weather resistance. The dielectric constant is 2.3 for solid insulation and 1.64 for foam designs. Flame retardant formulations are available with dielectric constants ranging from about 1.7 for foam flame retardant to 2.58 solid flame retardant polyethylene.	This material has excellent electrical properties, temperature range and chemical resistance. It is not suitable where subjected to nuclear radiation and does not have good high voltage characteristics. FEP Teflon is extrudable in a manner similar to PVC and polyethylene. This means long wire and cable lengths are available. TFE Teflon is extrudable in hydraulic ram-type process. Lengths are limited due to amount of material in the ram, thickness of the insulation and preform size. TFE must be extruded over a silver- or nickel-coated wire. The nickel- and silver-coated designs are rated 260° C and 200° C maximum, respectively. The cost of Teflon is approximately 8 to 10 times more per pound than PVC compounds.

Comparative Properties of Insulation and Jacket

	PVC	Low-density Polyethylene
Oxidation Resistance	E	E
Heat Resistance	G-E	G
Oil Resistance	F	G-E
Low Temperature Flexibility	P-G	E
Weather, Sun Resistance	G-E	E
Ozone Resistance	E	E
Abrasion Resistance	F-G	G
Electrical Properties	F-G	E
Flame Resistance	E	P
Nuclear Radiation Resistance	F	G-E
Water Resistance	F-G	E
Acid Resistance	G-E	G-E
Alkali Resistance	G-E	G-E
Gasoline, Kerosene, Etc.		
(Aliphatic Hydrocarbons) Resistance	P	G-E
Benzol, Toluol, Etc., (Aromatic Hydrocarbons) Resistance	P-F	P
Degreaser Solvents (Halogenated Hydrocarbons) Resistance	P-F	G
Alcohol Resistance	G-E	E
Underground Burial	P-G	G

P = Poor F = Fair G = Good E = Excellent

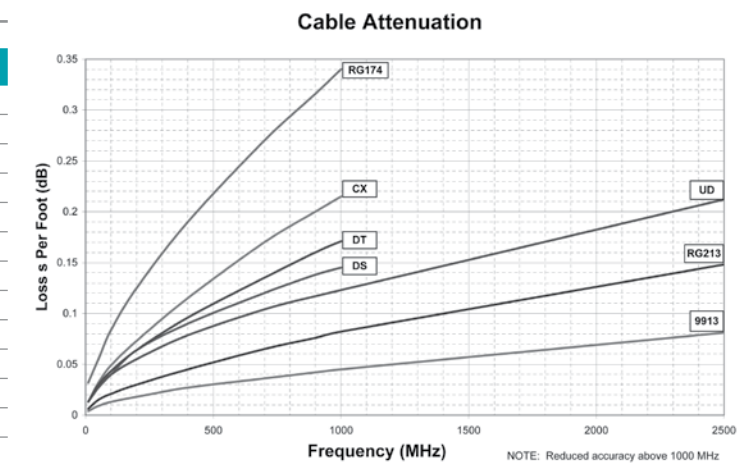

Nominal Temperature Range/Insulating and Jacketing Compounds

Compound	Normal Low	Normal High	Special Low	Special High
Polyethylene - Solid	-60° C	80° C	--	--
Polyethylene - Foam	-60° C	80° C	--	--
FEP Teflon	-70° C	200° C	--	--
PVC	-20° C	80° C	-55° C	105° C
TFE Teflon	-70° C	260° C	--	--



## CONTACT US TODAY!

- ☎ Call us at **+1.800.ANTENNA**
- 🌐 Visit our website at: **[pulselarsenantennas.com](http://pulselarsenantennas.com)**
- 🐦 Connect with us on twitter: **[PulseLarsen1](https://twitter.com/PulseLarsen1)**



Worldwide Headquarters  
San Diego, CA, USA  
15255 Innovation Drive #100  
San Diego, CA 92128  
**+1-858-674-8100**

Vancouver, WA, USA  
18110 SE 34th Street  
Suite 250, Building 2  
Vancouver, WA 98683  
Tel: **+1-360-944-7551**  
**[antennas.us@pulseelectronics.com](mailto:antennas.us@pulseelectronics.com)**

Europe - Finland  
Automaatitietie 1, FI-90440 Oulunsalo.  
Tel: **+358-20-7935-500**  
**[antennas.eu@pulseelectronics.com](mailto:antennas.eu@pulseelectronics.com)**

Europe - Germany  
Campus Berliner Allee  
Berliner Allee 65 D-64295  
Darmstadt Germany  
Tel: **+49.173.659.85.21**  
**[antennas.eu@pulseelectronics.com](mailto:antennas.eu@pulseelectronics.com)**

ISO Manufacturing Site  
No 99. Huo Ju road, Suzhou new District,  
Jiangsu Province, Suzhou, China, PRC.  
Tel: **+86-512-69206053**  
**[antennas.as@pulseelectronics.com](mailto:antennas.as@pulseelectronics.com)**

