

STRAIGHT BULKHEAD JACK-CRIMP TYPE
CABLE 2.6/50

SERIES:

BNC

1 / 2

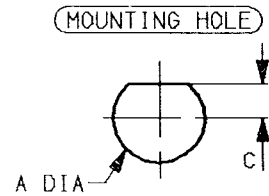
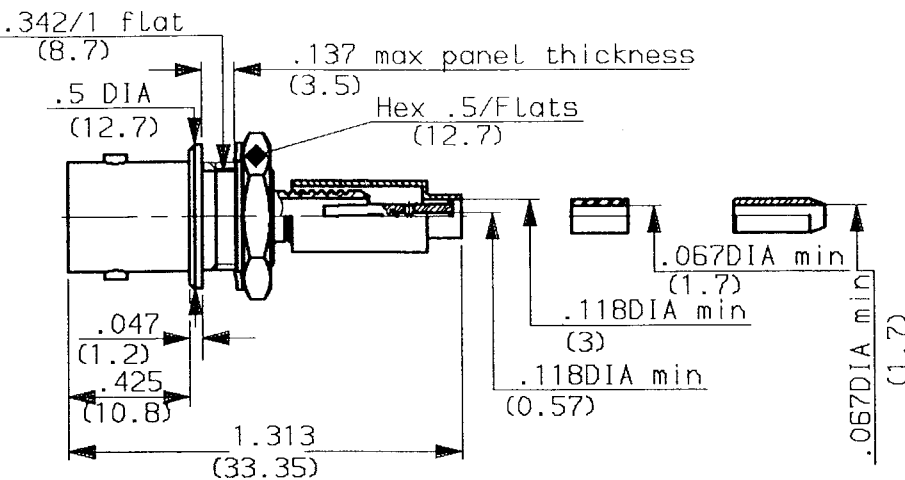

	MM		INCH	
	mini	maxi	mini	maxi
A	9.65	9.75	.380	.383
c	3.96	4.04	.156	.159

CABLES : RG174 KX3

weight oz (g)

CHARACTERISTICS

NOMINAL IMPEDANCE	50	Ω
FREQUENCY RANGE	0-4	GHz
TEMPERATURE RATING	-65/+165	°C
VSWR	AD	Max
RF INSERTION LOSS	AD	√F dB Maxi
VOLTAGE RATING	335	Vrms Maxi
DIELECTRIC WITHSTANDING VOLTAGE	1000	Vrms mini
INSULATION RESISTANCE	5000	MΩ mini
HERMETIC SEAL	NA	cc/s - Atm.cm ³ /s
LEAKAGE (pressurized only)	NA	psi - MPa

STANDARDISATION

CECC 22120 /BNC
CEI 169-08/BNC
MIL STD348-301/BNC

CABLE RETENTION

8.8 Lb mini
40 N

CENTER CONTACT RETENTION

Axial force - mating end 5.984 Lb mini
27.2 N
Axial force - opposite end 5.984 Lb mini
27.2 N
Torque (Min) NA Inch.oz
cm.N

RECOMMENDED TORQUES

Mating NA Inch.Lb
cm.N
Panel nut 22.125 Inch.Lb
250 cm.N
Clamp nut NA Inch.Lb
cm.N

CONSTRUCTION

CONNECTOR PARTS	MATERIALS	FINISH
BODY	BRASS	NICKEL
OUTER CONTACT	BRASS	NICKEL
CENTER CONTACT	BERYLLIUM COPPER	GOLD
INSULATORS	PTFE	-
-	-	-
-	-	-
-	-	-
-	-	-
-	-	-

ISSUE	REVISION No	DESCRIPTION	BY	DATE
9737	9506.015	braid clamp PTFE → Polyamide	Guerin	17.09.97

Initiated on 31-MAR-92

The information given here is subject to change without notice. Design changes may be in order to improve the product.



Superseded on

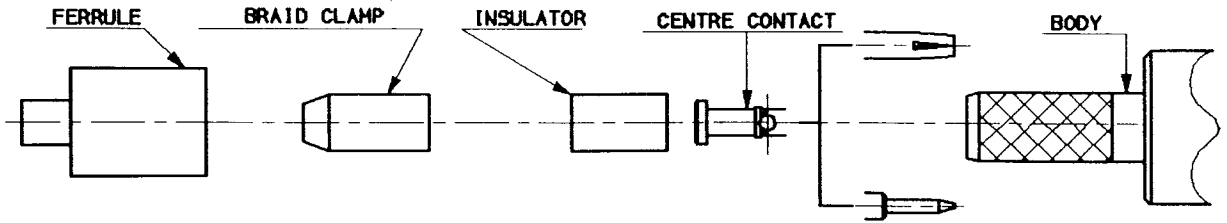

①

- 1-1 Slide onto the cable the ferrule
- 1-2 Strip the cable .
- 1-3 Fan the braid .

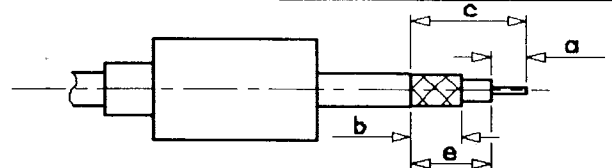

Stripping	a	b	c	d	e
Inch	.157	.393	.728	-	.57
mm	4	10	18.5	-	14.5

②

- 2-1 Slide the braid clamp and insulator between the dielectric and the braid .
- 2-2 Slide on the centre contact until it bottoms against cable dielectric .
- 2-3 Crimp centre contact , crimping tool R 282 223 000 (Hex. .068) or crimping tool M22520/5-01 + dies M22520/5-11

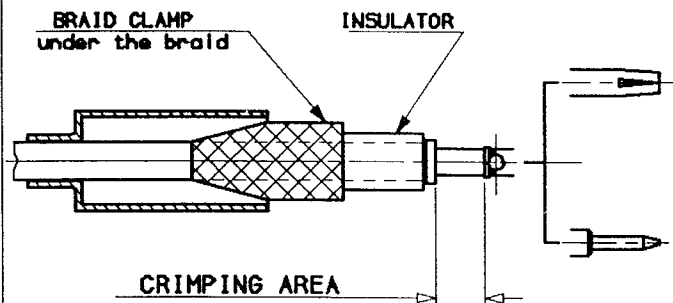

③

- 3-1 Slide cable into the body until bottoms against insulator .
- 3-2 Slide ferrule over the braid (in direction F)

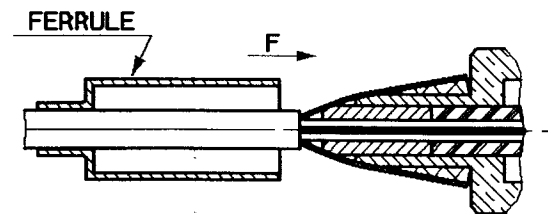

④

- 4-1 Crimp the ferrule with crimping tool R 282 223 000 (Hex. .213) or Crimping tool M22520/5-01 + dies M22520/5-11
- 4-2 Cut the excess of braid .

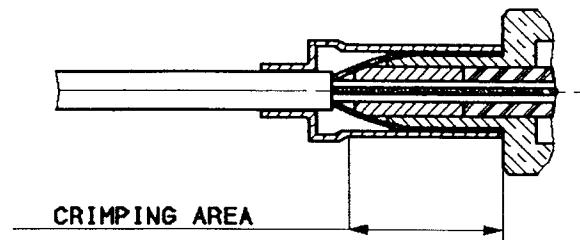

ISSUE	REVISION No	DESCRIPTION	BY	DATE

Initiated on 31-MAR-92
Superseded on _____

The information given here is subject to change without notice. Design changes may be in order to improve the product.

