

Product Name :Electronic Components / Nema Connectors / ENO-3123F
Product Code : ENO-3123F



Approvals



Features

NEMA Receptacles are available in wide range of current & Voltage ratings
Wide range of mounting styles and terminals to suit various design requirements
Components available according to UL and NEMA standards
Wide range of operating temperature - up to 125 Deg Centigrade
All the safety approvals are available for any colour.

BASIC DIMENSIONS

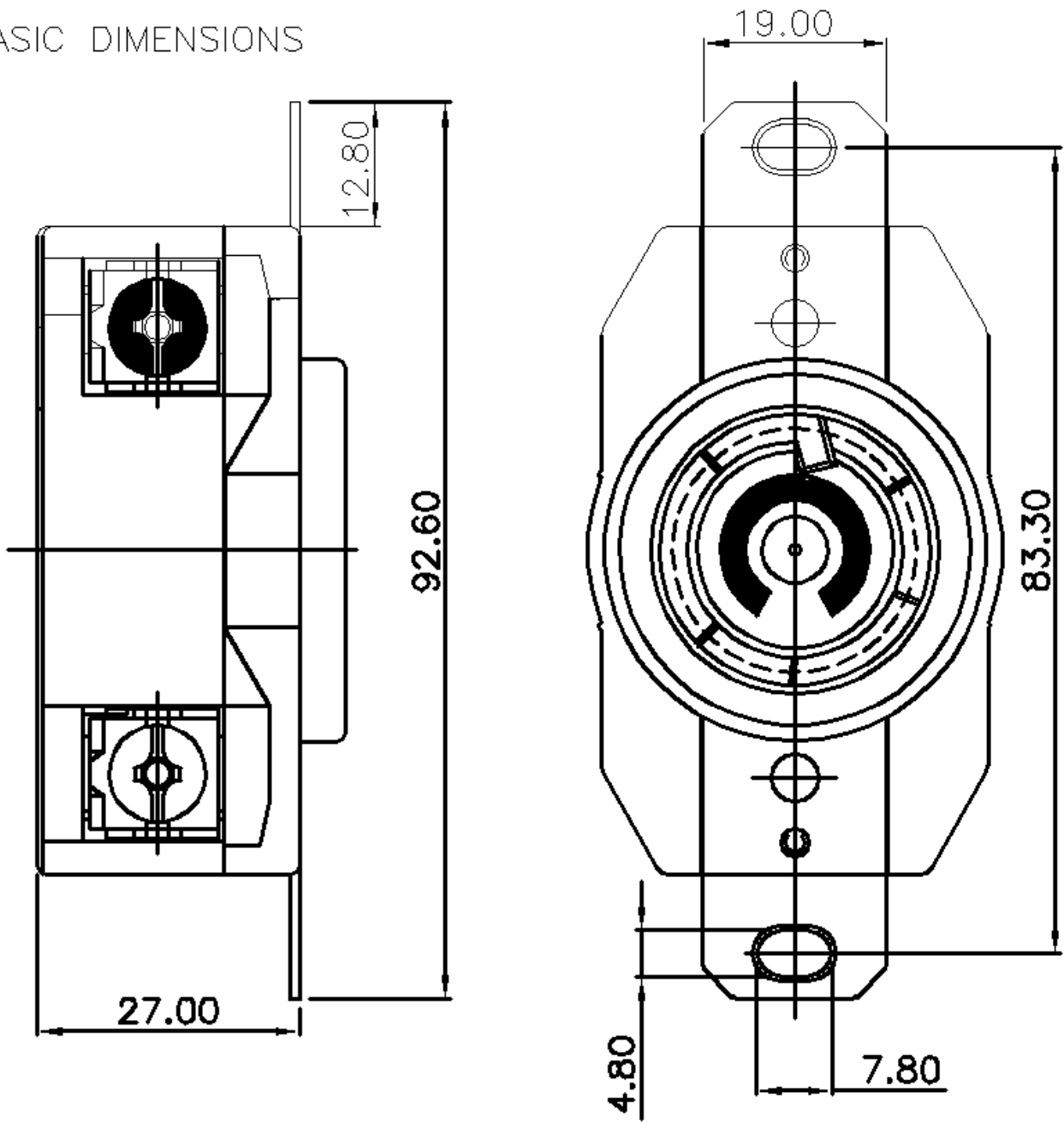



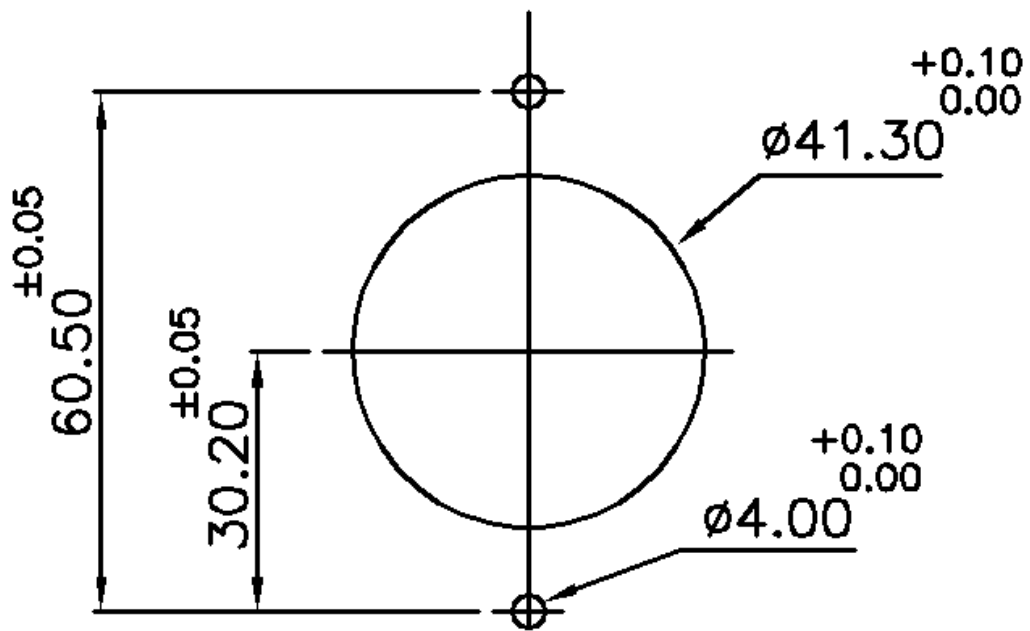



PANEL CUTOUT





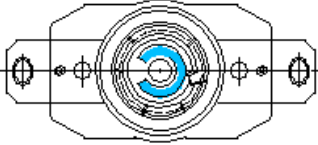



Specifications

Sr.No	Parameter		Specification
1	Product Category / Description		NEMA Receptacle
2	Type / Sub Type		Twist Lock
3	NEMA Type		L6-30R Type
4	Gender		Female
	Electrical Characteristics		
5	V/A Rating		250VAC 30A
6	Insulation Resistance at 500 VDC		100 M ohms Min.
7	H.V.Break Down Test (For 1-Minute)		2 KVAC
8	Contact Resistance (Initial)		10 m ohms Max
	Operating / Functional Characteristics		
9	Operating Temp. Range	With/Without Load	0 To 65°C
10	Flammability Rating		UL 94 V-2
11	Mounting Style		Screw - Type
12	Terminals (Standard)		Screw - Type # 14 To # 8 AWG
13	Tightening Torque		12 Kg. cm. Minimum
	Material		
14	Body		Thermoplastic
15	RoHS compliant		Yes
16	Colour (Standard)	Colour	Black
17	Current Carrying Parts	(b) Contacts, Terminals	Cu Alloy
	Reference Standards / Safety Approvals		
18	Reference Standard		UL-498, UL-486E, NEMA WD 6:2002, CAN / CSA C22.2 No. 0-M91, CSA C22.2 No. 42-99
19	Safety Approvals		cULus, CSA

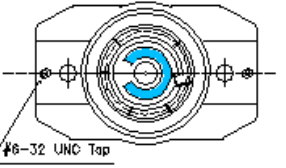
ANNEXURE A

Standard Variety				
Sr.no.	With Reference To	Available option	RoHS/Non RoHS	Safety Approvals & / Or Markings
1	Plastic Resin	Nylon 6 FR V-2		 
2	Mounting (With Flange)			 

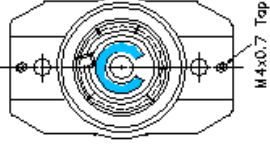
Other Customized Options Available On Request , Subject To MOQ & Commercial Acceptance.				
Sr.no.	With Reference To	Available options	RoHS/Non RoHS	Safety Approvals & / Or Markings
3	Body Colours	Any Colour in Nylon 6 FR V-2		 
4	Mounting Thread Type	 #6-32 UNC Tap		 
5	Mounting Thread Type	 M4x0.7 Tap	